



Relay and Timer Specifications

Bulletin 700

Topic	Page
Summary of Changes	2
General Information	3
Contact Data Tables	3
NEMA Ratings and Test Values	5
Timing Relay Selection Criteria	7
General Purpose Relays	9
Product Overview	9
700-HA General-purpose Relays	12
700-HB Square Base Relay	23
700-HD Flange Mount Square Base Relay	29
700-HF Square Base Relay	33
700-HC Miniature Ice Cube Relay	40
700-HK Slim Line Relay	46
700-HL Terminal Block Relay	54
700-HL_N Next Generation Terminal Block Relay	61
700-HL 2-pole Terminal Block Relay	68
700-HLF Terminal Block Timing Relay	72
700-HP Slim Line Relay	76
700-HPS Safety Control Relay	77
700-HJ Magnetic Latching Relay	82
700-HG Power Relay	87
700-HHF Flange Mount Power Relay	92
700-HTA Alternating Relay	94
General-purpose Electronic Timers and Counters	100
Product Overview	100
700-FE Economy Timing Relay	103
700-FS High-Performance Timing Relay	107
700-HNC Miniature Timing Relay	111
700-HNK Ultra-Slim Timing Relay	117
700-HR Dial Timing Relays	123
700-HT Timing Relays	134
700-HV Timing Relay	138
700-HX Multi-Function Digital Timing Relay	142

Topic	Page
NEMA Industrial Relays	152
700-P Industrial Relays	154
700S-P and 700S-PK Heavy-duty Safety Control Relays	167
700-N Industrial Relays	172
700-R Sealed Switch Relays	178
700-RTC – Solid-State Timing Relay	183
Solid-state Relays	225
Product Overview	225
700-SA Tube Base Relays	229
700-SC Ice Cube Relays	225
700-SF Square Base Relays	225
700-SH Hockey Puck Relays	225
700-SK Slim Line Relays	225
Additional Resources	257

Summary of Changes

This publication contains the following new or updated information. This list includes substantive updates only and is not intended to reflect all changes.

Topic	Page
Updated accessory selection and specification information	throughout
Added accessories for Bul 700-FE timing relays	103
Added accessories for Bul. 700-N relays	173

Timing Relays

Relay Type	Contact Arrangement	Contact Style	Contact Material	NEMA Pilot Duty	AC and DC Switching Capability													
					1 mA	10 mA	50 mA	100 mA	1 A	3 A	5 A	10 A	20 A	25 A	30 A	35 A		
700-FE	1 N.O.	single	AgCdO	D300			10V	AC DC (24V Max)										
700-FS	1, 2 form C	single	AgCdO	B300			10V	AC DC (24V Max)										

General Purpose Relays

Relay Type	Contact Arrangement	Contact Style	Contact Material	NEMA Pilot Duty	AC and DC Switching Capability													
					1 mA	10 mA	50 mA	100 mA	1 A	3 A	5 A	10 A	20 A	25 A	30 A	35 A		
700-HA	2, 3 form C	single	AgNi	B300			10V	AC DC (24V Max)										
700-HAX	2, 3 form C	bifurcated	Au/AgNi	B300	6V	AC DC (24V Max)												
700-HB	2, 3 form C	single	AgNi	B300			10V	AC DC (24V Max)										
700-HC14	4 form C	single	Ag/Au	C300 Q300	10V	AC DC (30V Max)												
700-HC22	2 form C	single	AgNi	B300 Q300			10V	AC DC										
700-HC24	4 form C	single	AgNi	C300 Q300			10V	AC DC (30V Max)										
700-HD	2, 3 form C	single	AgCdO	B300			10V	AC DC (24V Max)										
700-HF	2, 3, 4 form C	single	AgCdO	B300			10V	AC DC (30V Max)										
700-HG	1 form X, 1 form C, 2 form A, 2 form C	single	AgNi	A600			10V	AC DC (28V Max)										
700-HHF45	1 form X	single	AgNi	A600			10V	AC DC (28V Max)										
700-HHF62	2 form C	single	AgNi	B600			10V	AC DC (28V Max)										
700-HHF73	3 form C	single	AgNi	B300			10V	AC DC (28V Max)										

General Purpose Relays (Continued)

Relay Type	Contact Arrangement	Contact Style	Contact Material	NEMA Pilot Duty	AC and DC Switching Capability											
					1 mA	10 mA	50 mA	100 mA	1 A	3 A	5 A	10 A	20 A	25 A	30 A	35 A
700-HJ	1, 2 form C	single	AgCdO	—			10V	AC/DC (24V Max)								
700-HK36	1 form C	single	AgNi	B300			10V	AC/DC (30V Max)								
700-HKX36	1 form C	single	Au/AgNi	B300												
700-HK32	2 form C	single	AgNi	B300		5V	AC/DC (30V Max)									
700-HKX32	2 form C	single	Au/AgNi	B300												
700-HLS	Solid-state 1 N.O.	—	—	—	3V	AC/DC										
700-HLT	1 Form C	single	AgSnO	B300 R300		12V	6 A AC/DC									
700-HLT_X	1 Form C	single	AgSnO	B300 R300	8V	6 A AC/DC										
700-HP	2 Form C	single	AgNi	B300 Q300	5V (300 mW)	8 A AC/DC										
700-HPX	2 Form C	single	AgNi + Gold	B300 Q300	5V (50 mW)	8 A AC/DC										
700-HS	2 Form C	single	AgCdO	B300		10V	AC/DC (30V Max)									
700-HT	2 form C	single	AgNi	B300		10V	AC/DC (30V Max)									

NEMA Ratings and Test Values




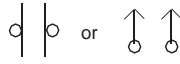
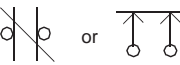
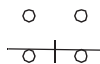
NEMA Ratings and Test Values for AC Control Circuit Contacts at 50 or 60 Hz

NEMA Contact Rating Designation	Thermal Continuous Test Current [A]	Maximum Current [A]									
		120V		240V		480V		600V		VA	
		Make	Break	Make	Break	Make	Break	Make	Break	Make	Break
A150	10	60	6.00	—	—	—	—	—	—	7200	720
A300	10	60	6.00	30	3.00	—	—	—	—	7200	720
A600	10	60	6.00	30	3.00	15	1.50	12	1.20	7200	720
B150	5	30	3.00	—	—	—	—	—	—	3600	360
B300	5	30	3.00	15	1.50	—	—	—	—	3600	360
B600	5	30	3.00	15	1.50	7.5	0.75	6	0.60	3600	360
C150	2.5	15	1.50	—	—	—	—	—	—	1800	180
C300	2.5	15	1.50	7.5	0.75	—	—	—	—	1800	180
C600	2.5	15	1.50	7.5	0.75	3.75	0.375	3	0.30	1800	180
D150	1.0	3.60	0.60	—	—	—	—	—	—	432	72
D300	1.0	3.60	0.60	1.8	0.30	—	—	—	—	432	72
D600	0.5	1.80	0.30	—	—	—	—	—	—	216	36
2X A300	20	120	12	60	6.00	—	—	—	—	14400	1440
2X A600	20	120	12	60	6.00	30	3.00	24	2.40	14400	1440

NEMA Ratings and Test Values for DC Control Circuit Contacts

NEMA Contact Rating Designation	Thermal Continuous Test Current [A]	Maximum Current [A]				Make or Break at 300V or less [VA]
		5...28V	125V	250V	301...600V	
N150	10	10	2.2	—	—	275
N300	10	10	2.2	1.1	—	275
N600	10	10	2.2	1.1	0.40	275
P150	5.0	5.0	1.1	—	—	138
P300	5.0	5.0	1.1	0.55	—	138
P600	5.0	5.0	1.1	0.55	0.20	138
Q300	2.5	2.5	0.55	0.27	0.11	69
Q600	2.5	2.5	0.55	0.27	0.11	69
2X P600	10	10	2.2	1.1	0.40	275

NEMA Definitions for Contact Arrangements

Contact Arrangement	Description	Diagram
Form A	A Form A contact arrangement is one that has single-pole, single-throw, normally open contacts. The function of this arrangement is to close a circuit when actuated.	
Form B	A Form B contact arrangement is one that has single-pole, single-throw, normally closed contacts. The function of this arrangement is to open a circuit when actuated.	
Form C	A Form C contact arrangement is one that has single-pole, double-throw contacts with three terminals - one for normally open, one for normally closed, and one common. The function of this arrangement is to transfer a circuit when actuated.	
Form X	A Form X contact arrangement is one that has single-pole, single-throw, normally open double-make contacts. The function of this arrangement is to close a circuit when actuated.	
Form Y	A Form Y contact arrangement is one that has single-pole single-throw normally closed double-break contacts. The function of this arrangement is to open a circuit when actuated.	
Form Z	A Form Z contact arrangement is one that has single-pole, double-throw, contacts with four terminals – two for normally open and two for normally closed. The function of this arrangement is to open one circuit and close the other.	

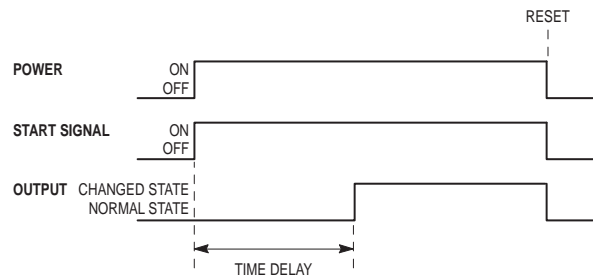
Timing Relay Selection Criteria

Single-function Timers: Timers that have only 1 timing mode (for example, On-delay or OFF-Delay).

Multi-function Timers: Timers that have 4...8 timing modes that are selected by turning the mode selection switch.

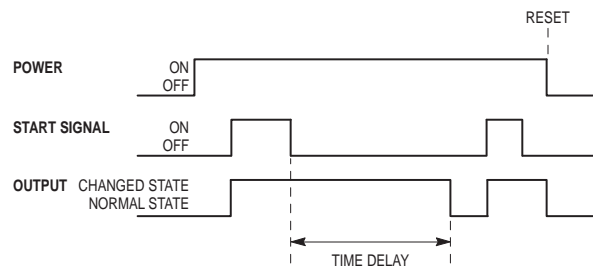
On-delay or (Delay on Operate)

When power is applied continuously (or when power and a start signal are applied), the timing cycle begins. The output contacts change state after the time delay is completed. The contacts return to their normal state when a reset signal is applied or power is removed.



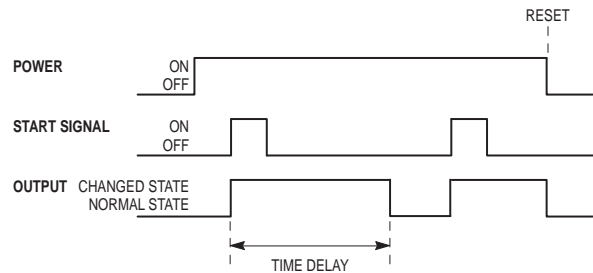
OFF-Delay or (Delay on Release)

Power is applied continuously. When a start signal is applied, the output contacts change state immediately. When the start signal is removed, the timing cycle begins. The output contacts return to their normal state once the time delay is completed. Reset occurs when a reset signal is applied or power is removed.



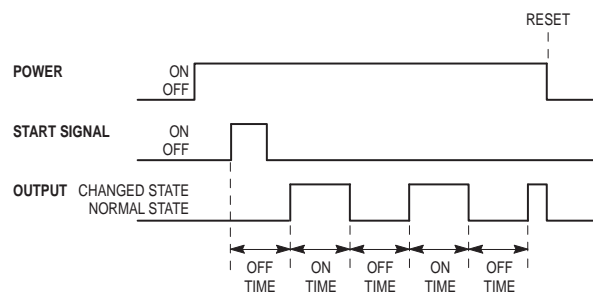
One Shot or (Repeat Cycle)

Power is applied continuously. When a start signal is applied, the output contacts change state immediately and the timing cycle begins. The output contacts return to their normal state once the time delay is completed. Reset occurs when a reset signal is applied or power is removed.



Repeat Cycle or (Flicker)

Power is applied continuously. When a start signal is applied, the timing cycle begins. When the time delay is completed, the output contacts change state and the next timing cycle begins. This cycle repeats until a reset signal is applied or power is removed.



Flexibility

Mounting — Timing relays are available in several different models. They can be plugged into the same socket as the relay, or use a separate plug-in socket mounting.

Contacts — The contacts are of various types and ratings. See the appropriate specification pages for more details.





Functionality — Timing relays with multi-range and multi-function capability are available. This lets you stock one relay to cover a wide variety of applications.





External Trigger Switch — OFF-Delay, One-Shot, and other timer functions require an external trigger switch (from a relay or push button) to control the timing function. The external trigger switch causes the timing function to start. In OFF-Delay, the trigger switch closes to energize the output and when the trigger switch opens the OFF-Delay starts to time out. At the end of the time delay, the output is de-energized and the output contacts return to their shelf state.




Surge Suppression Information

Photo	Cat. No.	For use with	Suppression Technique	Max Relay Contact Dropout Time	Max Transient Voltage Relative to System Voltage
	700-ADR	700-HA, -HB, -HK, -HP (6...220V DC)	Diode	3X	—
	700-ADL1	700-HC (6...24V DC)	Diode + LED	3X	—
	700-ADL1R	700-HB, -HA, -HK, -HP (6...24V DC)	Diode + LED	3X	—
	700-ADL2	700-HC (28...60V DC)	Diode + LED	3X	—
	700-ADL2R	700-HB, -HA, -HK, -HP (28...60V DC)	Diode + LED	3X	—
	700-ADL3	700-HC (110...220V DC)	Diode + LED	3X	—
	700-ADL3R	700-HB, -HA, -HK, -HP (110...220V DC)	Diode + LED	3X	—
	700-AR1	700-HB, -HA, -HC, -HK, -HP (6...24V AC/DC)	RC	No Effect	3
	700-AR2	700-HB, -HA, -HC, -HK, -HP (110...240V AC/DC)	RC	No Effect	—
	700-AV1R	700-HB, -HA, -HC, -HK, -HP (6...24V AC)	Varistor + LED	No Effect	—
	700-AV3R	700-HB, -HA, -HC, -HK, -HP (110...240V AC)	Varistor + LED	No Effect	—
	700-CF built-in	—	Diode	—	6...10X
	100-FSC	100C, 700-CF	R-C Ckt	No Effect	3X
	100-FSV	100C, 700-CF	MOV	No Effect	—
	100-FSD	100C, 700-CF	Diode	70...95 ms	6...10X
	100-JE	100C, 700-CF	Diode	5X	6...10X
	700-N5	700-P, 700-N	RC	No effect	3X
	700-N24	700-P, 700-N	RC	No effect	3X
	700-R built-in	—	Diode	—	6...10X
	199-FSMA1, FSMA2	700-P, 700-H, 700-CF, 700DC-R	RC	No effect	3X
	199-FSMA9, 10, 11	700-P, 700-H, 700-CF, 700DC-R	MOV	No effect	—
	199-FSMZ	700-P, 700-H, 700-CF, 700DC-R	Diode	5X	—

Product Overview

				
Bulletin No.	700-HA	700-HB	700-HD	700-HF
Type	General-purpose Relay	General-purpose Relay	General-purpose Relay	General-purpose Relay
Features	<ul style="list-style-type: none"> Pin-style terminals Standard ON/OFF flag indicator Electrical schematic on face Clear cover for visual inspection Optional push-to-test and manual override Optional LED 	<ul style="list-style-type: none"> Blade-style quick connect terminals Standard ON/OFF flag indicator Electrical schematic on face Clear cover for visual inspection Optional push-to-test and manual override Optional LED 	<ul style="list-style-type: none"> Flange-mounted Blade-style quick connect terminals Clear cover for visual inspection 	<ul style="list-style-type: none"> Square-base Plug-in quick connect solder terminals Optional push-to-test Optional LED
Contact Ratings				
Contact Form	DPDT, 3PDT	DPDT, 3PDT	DPDT, 3PDT	DPDT, 4 PDT
Contact Type	Single	Single	Single	Single
Contact Material	AgNi, AgNi + Gold	AgCdO	AgCdO	AgCdO
Operating Current, Under Resistant Load, Max	700-HA: 10 A 700-HAX: 6 A	15 A	15 A	10 A
Permissible Load, min	700-HA: 10V, 5 mA 700-HAX: 6V, 1 mA	10V, 10 mA	10V, 10 mA	5V, 100 mA
Coil Ratings				
Coil Voltage	AC: 6, 12, 24, 48, 110, 120, 230, 240, 277V DC: 6, 12, 24, 36, 48, 60, 80, 110, 125, 140, 220V	AC: 6, 12, 24, 120, 240V DC: 6, 12, 24, 48, 110V	AC: 6, 12, 24, 120, 208, 240V DC: 6, 12, 24, 48, 110V	AC: 6, 12, 24, 120, 240V DC: 6, 12, 24, 48, 110V
Permissible Coil Voltage Variation		80...110% of nom voltage at 50 Hz 80...110% of nom voltage at 60 Hz 80...110% of nom voltage at DC		85...110% of nom voltage at 50 Hz 85...110% of nom voltage at 60 Hz 80...110% of nom voltage at DC
Electrical Ratings				
Dielectric Withstand Voltage	Pole-to-pole: 2000V Contact-to-coil: 2000V Contact-to-frame: 2000V	Pole-to-pole: 2500V Contact-to-coil: 4000V Contact-to-frame: 2500V	Pole-to-pole: 2500V Contact-to-coil: 4000V Contact-to-frame: 2500V	Pole-to-pole: 1500V Contact-to-coil: 1500V Contact-to-frame: 1500V
Electrical Service Life (Cycles)	100,000 min	100,000 min	100,000 min	200,000 min 500,000 min (DPDT)
Reference				
Certifications	CE, cULus, cURus, CSA, Lloyds	CE, cULus, cURus, CSA, Lloyds	CE, UR, CSA, Lloyds	CE, UR, CSA
Socket Catalog Numbers	700-HN100, 700-HN101, 700-HN125, 700-HN126, 700-HN204, 700-HN205	700-HN153, 700-HN154	—	700-HN262, 700-HN264
Page	12	23	29	33

				
Bulletin Number	700-HC	700-HK	700-HL	700-HP
Type	Interposing/Isolation Relay	Interposing/Isolation Relay	Interposing/Isolation Relay	Interposing/Isolation Relay
Features	<ul style="list-style-type: none"> • Blade-style terminals • Standard ON/OFF flag indicator • Electrical schematic on face • Clear cover for visual inspection • Optional push-to-test and manual override • Optional LED 	<ul style="list-style-type: none"> • Optional pilot light • Retainer clip (comes with socket) • Low switching capacity • Push-to-test and manual override 	<ul style="list-style-type: none"> • Ideal for PLC Interfaces • Built-in Coil Surge Protection • Fully Assembled Relay/Sockets • Standard LED • Relay or Solid-state Output • Optional: Leakage Current Suppression Solution 	<ul style="list-style-type: none"> • PCB "Pin Style" mounting • 5 mm pin spacing
Contact Ratings				
Contact Form	DPDT, 4PDT	SPDT, DPDT	SPDT 1 N.O. (SSR)	DPDT
Contact Type	Single	Single	Single	Single
Contact Material	AgNi, AgNi + Gold	AgNi, AgNi + Gold	AgSnO	AgNi, AgNi + Gold
Operating Current, Under Resistant Load, Max	10 A (DPDT) 7 A (4PDT)	8 A (DPDT), 16 A (SPDT)	6 A (SPDT), 2 A (SSR DC output), 2 A (SSR AC output)	8 A
Permissible Load, min	10V, 10 mA (Gold), 5V, 10 mA or 25V, 2 mA (Silver)	5V 60 mA (Silver), 5V 10 mA (Gold)	12V 6 mA (72 mW) Silver 8V, 2.5 mA (20 mW) Gold	5V 5 mA (50 mW) Gold, 5V 5 mA (300 mW) Silver
Coil Ratings				
Coil Voltage	AC: 6, 12, 24, 120, 240V DC: 6, 12, 24, 48, 110V	AC: 6, 12, 24, 120, 240V DC: 6, 12, 24, 48, 110V	AC: 12, 24, 48, 110, 120, 230, 240V DC: 12, 24, 48, 125, 230, 240V	AC: 6, 12, 24, 120, 240V DC: 6, 12, 24, 48, 110V
Permissible Coil Voltage Variation	80...110% of nom voltage at 50 Hz 80...110% of nom voltage at 60 Hz 80...110% of nom voltage at DC	80...110% of nom voltage at 50 Hz 80...110% of nom voltage at 60 Hz 73...110% of nom voltage at DC	85...110% of nom voltage at 50 Hz 85...110% of nom voltage at 60 Hz 80...110% of nom voltage at DC	80...110% of nom voltage at 50 Hz 80...110% of nom voltage at 60 Hz 73...150% of nom voltage at DC
Electrical Ratings				
Dielectric Withstand Voltage	Pole-to-pole: 1000V Contact-to-coil: 2000V Contact-to-frame: 2000V	Pole-to-pole: 1500V Contact-to-coil: 1500V Contact-to-frame: 1500V	Pole-to-pole: 1000V Contact-to-coil: 4000V Contact-to-frame: 1500V	Pole-to-pole: 2000V Contact-to-coil: 5000V
Electrical Service Life (Cycles)	100,000 min	100,000 min	100,000 min	100,000 min
Reference				
Certifications	CE, cULus, cURus, CSA, Lloyds	CE, UL, UR, CSA	CE, cURus, cULus, ABS	CE, cULus, cURus, CSA, Lloyds
Socket Catalog Numbers	700-HN103, 700-HN128, 700-HN104	700-HN121, 700-HN221, 700-HN122, 700-HN222, 700-HN223, 700-HN224	—	700-HN123, 700-HN230
Page Number	40	46	54	76

			
Bulletin Number	700-HJ	700-HG	700-HHF
Type	Magnetic Latching Relay	Power Relay	Power Relay
Features	<ul style="list-style-type: none"> • Socket mounted • Ideal for lighting applications 	<ul style="list-style-type: none"> • Panel mount with screw terminals • Optional magnetic blowouts for switching DC loads • Optional snap action switch 	<ul style="list-style-type: none"> • Flange mounted • Optional LED
Contact Ratings			
Contact Form	SPDT, DPDT (Single or Dual Coil)	SPST-N.O.-DM, SPDT, DPST-N.O., DPDT	SPST-NO-DM, DPDT, 3PDT
Contact Type	Single	Single	Single
Contact Material	AgCdO	AgNi	AgNi
Operating Current, Under Resistive Load, Max	10 A	40 A	20 A (3PDT), 25 A (DPDT), 30 A (SPDT)
Permissible Load, min	10V 50 mA	10V 50 mA	10V 50 mA 10V 100 mA (3PDT)
Coil Ratings			
Coil Voltage	AC: 24V, 120V, 240V DC: 12V, 24V	AC: 24V, 120V, 240V, 277V, 480V DC: 12V, 24V, 48V, 110V, 220V, 250V	AC: 24V, 120V, 240V DC: 6V, 12V, 24V
Permissible Coil Voltage Variation	85...110% of nom voltage at 50 Hz 85...110% of nom voltage at 60 Hz 80...110% of nom voltage at DC	85...110% of nom voltage at 50 Hz 85...110% of nom voltage at 60 Hz 80...110% of nom voltage at DC	85...110% of nom voltage at 50 Hz 85...110% of nom voltage at 60 Hz 80...110% of nom voltage at DC
Electrical Ratings			
Dielectric Withstand Voltage	Pole-to-pole: 1500V AC Contact-to-coil: 1500V AC Contact-to-frame: 1500V AC	Pole-to-pole: 2200V AC Contact-to-coil: 2200V AC Contact-to-frame: 2200V AC	Pole-to-pole: 2200V AC Contact-to-coil: 2200V AC Contact-to-frame: 2200V AC
Electrical Service Life (Cycles)	100,000 minimum	100,000 minimum	100,000 minimum
Reference			
Certifications	CE, UR, CSA	CE, UL, CSA	CE, UR, CSA
Socket Catalog Numbers	700-HN153, 700-HN154	—	—
Page Number	82	87	92

700-HA General-purpose Relays

- 10 A contact rating
- DPDT, 3PDT
- Pin-style terminals
- Standard ON/OFF flag indicator
- Options: LED, push-to-test and manual override, socket-mounted surge suppressor module, or multi-function timer
- Contact choices: standard silver nickel, or bifurcated silver nickel with gold plating



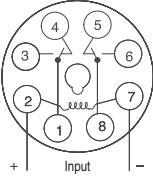
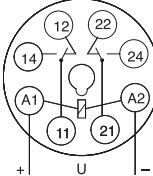
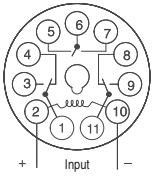
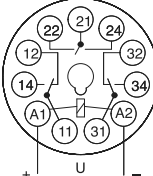
Product Selection

Tube Base Relay with PIN Terminals (Single Contact) – Mechanical ON/OFF Indicator Included⁽¹⁾

Description	Contact Rating	Wiring Diagrams		Coil Voltage	Cat. No. ⁽²⁾
		U.S./Canada	International		
DPDT 2-pole 2 Form C Single AgNi Contact	10 A, B300			6V AC	700-HA32A06
				12V AC	700-HA32A12
				24V AC	700-HA32A24
				120V AC	700-HA32A1
				240V AC	700-HA32A2
				277V AC	700-HA32A27
				6V DC	700-HA32Z06
				12V DC	700-HA32Z12
				24V DC	700-HA32Z24
				36V DC	700-HA32Z36
				48V DC	700-HA32Z48
				60V DC	700-HA32Z60
				80V DC	700-HA32Z80
				110V DC	700-HA32Z1
125V DC	700-HA32Z01				
Sockets		700-HN125	700-HN100 700-HN204	140V DC	700-HA32Z3
				220V DC	700-HA32Z2
3PDT 3-pole 3 Form C Single AgNi Contact	10 A, B300			6V AC	700-HA33A06
				12V AC	700-HA33A12
				24V AC	700-HA33A24
				120V AC	700-HA33A1
				240V AC	700-HA33A2
				6V DC	700-HA33Z06
				12V DC	700-HA33Z12
				24V DC	700-HA33Z24
				48V DC	700-HA33Z48
				60V DC	700-HA33Z60
				80V DC	700-HA33Z80
				110V DC	700-HA33Z1
				125V DC	700-HA33Z01
				Sockets	
				220V DC	700-HA33Z2





(1) For Time Modules and Surge Suppressor Modules, see [page 13](#).
 (2) LED Option: Add suffix (-4) to the selected 700-HA Relay Cat. No. For 240V AC Units, add (-4L).
 Push-to-test, Manual Override, and LED Option: Add suffix (-3-4) to the selected 700-HA Relay Cat. No. For 240V AC units, add (-3-4L).
 Push-to-test and Manual Override option: Add suffix (-3) to the selected 700-HA relay.
 LED not available for 220V DC and 277V AC coils.

Tube Base Relay with PIN Terminals (Bifurcated Contacts with Gold Overlay) – Mechanical ON/OFF Indicator Included



Description	Contact Rating	Wiring Diagrams		Coil Voltage	Cat. No
		U.S./Canada	International		
DPDT 2-Pole 2 Form C Bifurcated AgNi Contacts with Gold Plating	6 A			6V AC	700-HAX2A06
				12V AC	700-HAX2A12
				24V AC	700-HAX2A24
				120V AC	700-HAX2A1
				240V AC	700-HAX2A2
				277V AC	700-HAX2A27
				6V DC	700-HAX2Z06
				12V DC	700-HAX2Z12
				24V DC	700-HAX2Z24
				36V DC	700-HAX2Z36
				48V DC	700-HAX2Z48
110V DC	700-HAX2Z1				
Sockets		700-HN125	700-HN100 700-HN204	125V DC	700-HAX2Z01
				140V DC	700-HAX2Z3
3PDT 3-Pole 3 Form C Bifurcated AgNi Contacts with Gold Plating	6 A			6V AC	700-HAX3A06
				12V AC	700-HAX3A12
				24V AC	700-HAX3A24
				120V AC	700-HAX3A1
				240V AC	700-HAX3A2
				6V DC	700-HAX3Z06
				12V DC	700-HAX3Z12
				24V DC	700-HAX3Z24
				48V DC	700-HAX3Z48
				110V DC	700-HAX3Z1
				Sockets	
140V DC	700-HAX3Z3				

Accessories

Sockets and DIN Rail

	Description	For Use With	Pkg. Qty.	Cat. No.
	Screw Terminal Tube Base Socket • Panel or DIN Rail Mounting • 8-Pin	• Guarded Terminal Construction DPDT 700-HA Relays -HX Timing Relays -HT (On-delay) Timing Relays -HRM, -HRC and -HV (Repeat Cycle) Timing Relays	10	700-HN100
		• Open Style Construction • No retainer clip required	DPDT 700-HA Relays -HT (On-delay) Timing Relays -HRM, -HRC and -HV (Repeat Cycle) Timing Relays	10
	Screw Terminal Tube Base Sockets • Panel or DIN Rail Mounting • 11-pin	• Guarded Terminal Construction 3PDT 700-HA Relays	10	700-HN101
		• Open Style Construction • No retainer clip required	3PDT 700-HA Relays	10


Sockets and DIN Rail

	Description	For Use With	Pkg. Qty.	Cat. No.	
	Socket <ul style="list-style-type: none"> • Can Be Used With or Without Timing Attachment or Surge Suppressor • Screw Terminal Tube Base Sockets • Panel or DIN Rail mounting • Guarded terminal construction 	8-Pin	DPDT 700-HA Relays	10	700-HN204
		11-Pin	3PDT 700-HA Relays	10	700-HN205
	DIN (#3) symmetrical hat rail <ul style="list-style-type: none"> • 35 x 7.5 x 1 m 			10	199-DR1


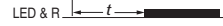


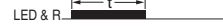
Socket and Retainer Clip Reference

Relay Cat. No.	Socket	Retainer Clip
700-HA32 700-HAX2	700-HN100	700-HN157
	700-HN125	Not Required
	700-HN204	700-HN157
700-HA33 700-HAX3	700-HN101	700-HN157
	700-HN126	Not Required
	700-HN205	700-HN157









Surge Suppressors

	Description	For Use With	Pkg. Qty.	Cat. No.
	Diode Surge Suppressor	700-HN204 and 700-HN205 sockets	10	700-ADR
			10	700-ADL1R
			10	700-ADL2R
			10	700-ADL3R
	Varistor Surge Suppressor with LED		10	700-AV1R
			10	700-AV3R
	RC Surge Suppressor		10	700-AR1
			10	700-AR2

Timing Modules

Photo	Description	Diagram	Cat. No.
	Timing Module <ul style="list-style-type: none"> • On-delay or One-Shot • used with sockets that accept plug-in accessory modules • Pkg. Qty: 1 	On-Delay U (A1/A2)  LED & R  One-Shot U (A1/A2)  LED & R 	12...24V AC/DC, selectable
			700-AT3
			700-AT3A1
	230...240V AC, selectable		700-AT3A2

Timing Modules (Continued)

Photo	Description		Diagram	Cat. No.
 <p data-bbox="342 365 857 575"> Multi-Function/Multi-Range Time Module • Voltage range 12...240V AC 50/60 Hz and 12...240V DC - voltage variation of 85...110% • Repeat accuracy of ± 1% • Reset time <50 ms • For use with 700-HA relays using 700-HN204 and 700-HN205 sockets • See 700-HT3 Timing Module Electrical Ratings on page 17 </p>	1. 1 s	0.05...1 s		700-HT3
	2. 10 s	0.5...10 s		
	3. 100 s	5...100 s		
	4. 10 min	0.5...10 min		
	5. 100 min	5...100 min		
	6. 10 hours	0.5...10 h		
	7. 100 hours	5...100 h		
	8. LED Indicator	—	—	

Specifications

700-HA Relays

Table 1 - Electrical Ratings

Attribute			700-HA Relay		
Pilot Duty Rating ⁽¹⁾			NEMA B300		
Rated Thermal Current (I_{th})		700-HA	10 A - 120V, 240V		
		700-HAX	6 A - 120V, 240V		
Rated Insulation Voltage (U_i)		IEC	250V		
		UL/CSA	300V		
Contacts	Inductive		Make	Break	Hp
			▶ ◀	◀ ▶	—
	120V AC		30 A	3 A	1/3
	240V AC		15 A	1.5 A	1
	General-purpose		10 A, 240V AC		
Resistive		10 A, 30V DC			
Minimum Low Energy Permissible Load		700-HA	10V, 5 mA		
		700-HAX	5V, 2 mA		
Permissible Coil Voltage Variation	Pickup		50 Hz	80...110% of nominal voltage	
			60 Hz	80...110% of nominal voltage	
			DC	80...110% of nominal voltage	
Coil Consumption $\pm 10\%$	AC Coils	Inrush	50 Hz	3.3VA	
			60 Hz	2.85VA	
		Sealed	50 Hz	2.2VA	
			60 Hz	1.9VA	
	DC Coils		1.3 W		
Must Dropout Voltage		V AC	20% of nominal voltage		
		V DC	10% of nominal voltage		
Max Contact Resistance		700-HA	50 M Ω		
		700-HAX	30 M Ω		
Design Specification/Test Requirements	Electrical	Dielectric Withstand Voltage	Pole-to-Pole	2000V	
			Contact to Coil	2000V	
	Electrical Life (Operating)		100,000 min		

(1) See [NEMA Ratings and Test Values on page 5](#)

Table 2 - Mechanical Ratings

Attribute			700-HA Relay		
Degree of Protection (Open Type) IEC 529			IP 40		
Mechanical Life Operations (AC/DC)			$> 20 \times 10^6 / 50 \times 10^6$		
Switching Frequency Operations			3600/h		
Coil Voltages			See page 12		
Operating Time	Pickup	12 ms			
	Dropout	12 ms			
Maximum Operating Rate			4 Ops/s		
Vibration	Endurance	5 G			
	Operational	2.5 G			
Shock	Endurance	50 G			
	Operational	9 G			

Table 3 - Environmental Ratings

Attribute		700-HA Relay	
Temperature	Operating	[°C]	-40...+70
		[°F]	-40...+158
	Storage	[°C]	-40...+100
		[°F]	-40...+212
Altitude		2000 m (6560 ft)	

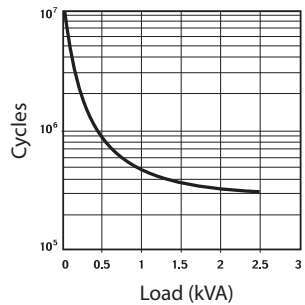
Table 4 - Construction

Attribute		700-HA Relay	
Insulating Material		Molded High-Dielectric Material	
Enclosure		Transparent Dust Cover	
Contact Material	700-HA	10 A - AgNi	
	700-HAX	6 A - Bifurcated/Gold Plating AgNi	
Terminal Markings on Socket		In accordance with EN50 0005	
Sockets	8-Pin	700-HN100, -HN125, -HN204	
	11-Pin	700-HN101, -HN126, -HN205	

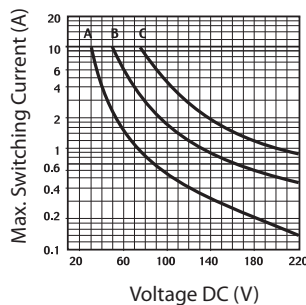
Table 5 - Standards Compliance and Certifications

Attribute	700-HA Relay
Certifications	<ul style="list-style-type: none"> cURus Recognized (File No. E3125, Guide NLDX2/NLDX8) cULus Listed when used with 700-HN sockets noted (File No. E3125, Guide NLDX/NLDX7) CE Marked CSA Certified UR Certified (File 229473)
Standards Compliance	<ul style="list-style-type: none"> UL508 CSA C22.2 No. 14, EN 61810-1

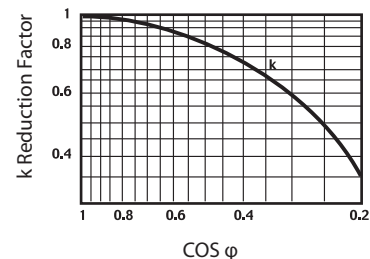
Figure 1 - 700-HA Relay Performance Graphs



Contact life vs. AC1 load at 1,800 cycles/h



Breaking capacity for DC1 load at 1,800 cycles/h
 A = load applied to one contact
 B = load applied to two contacts in series
 C = load applied to three contacts in series



Load reduction factor vs. cos φ

700-HT3 Timing Module Specifications

Table 6 - 700-HT3 Timing Module Electrical Ratings

Attribute		700-HT3 Timing Module	
Operating Voltage Range	AC	12...240V, 50/60 Hz	
	DC	12...240V	
Power Consumption	12V	0.1 W	
	230V)	1.0 W (

Table 7 - 700-HT3 Timing Module Mechanical Ratings

Attribute		700-HT3 Timing Module
Degree of Protection of Input (B1) Terminal		IP 20 (Guarded Terminal)
Input Terminal Wire Range	1 conductor	0.2...2.5 mm ² (24 ...14 AWG)
	2 conductors	0.2...1.5 mm ² (24...16 AWG)
Input Terminal Torque Range		0.45...0.8 N•m (4...7 lb•in)
Status Indicator		Red
Repeat Accuracy ⁽¹⁾		±1%
Recovery Time		<50 ms
Selectable Timing Ranges	Three DIP switches, seven ranges	(set from 5...100% of range): 1 s, 10 s, 100 s, 10 min, 100 min, 10 h, 100 h
Selectable Timing Modes	Three DIP switches, eight modes	1. Power On-Delay 2. Power On One-Shot 3. Power On Repeat Cycle, On Start 4. Signal On-delay and Signal Off-delay 5. Signal Off-delay 6. Signal On-One-Shot 7. Signal Off-One-Shot 8. Signal On and Signal Off Watchdog Monitor
Adjustable Trimmer Scale Accuracy		±5% of Time Range

(1) At constant voltage and temperature.

Table 8 - 700-HT3 Timing Module Environmental Ratings

Attribute			700-HT3 Timing Module
Temperature	Operating	[°C]	-20...+50
		[°F]	-4 ...+122
	Storage	[°C]	-55...+85
		[°F]	-67...+185
Altitude			2000 m (6560 ft)

Table 9 - 700-HT3 Timing Module Construction

Attribute		700-HT3 Timing Module
Enclosure		Gray Plastic Housing
Mounting with Socket Only		8- or 11-Pin Socket with Module Plug
Sockets	8-Pin with plug	700-HN204
	11-Pin with plug	700-HN205

Table 10 - 700-HT3 Timing Module Standards Compliance and Certifications

Attribute	700-HT3 Timing Module
Certifications	<ul style="list-style-type: none"> cURus Recognized (File No. E14843, Guide NRNT2/NRNT8) CE Marked
Standards Compliance	<ul style="list-style-type: none"> UL508, CSA C22.2 No. 14 EN 61810-1

Timing Chart

Terms:

- **U** is Power Input
- **R** is Relay Output
- **S** Signal, +A1 Socket, B1 Timer
- **t** is the resulting Time Delay (Red light-emitting diode)

700-HT3 Multi-function Time Module (t = Time Range 0.05 s...100 h)

Timing Mode	Description	Timing Chart	DIP Switch Selection	Wiring
1. Power On-delay	Apply power (U) to timer. Relay contacts (R) change state after time delay (t) is complete. Contacts return to their shelf state when power is removed. Terminal B1 is not used in this mode			
2. Power On One-shot	Apply power (U) to timer. Relay contacts (R) change state immediately and the time delay begins. When the time delay (t) is complete, contacts return to their shelf state. Contacts return to their shelf state when power is removed. Terminal B1 is not used in this mode.			
3. Power On Repeat Cycle, On Start	Apply power (U) to timer. Relay contacts (R) change state immediately and the time delay (t) begins. When the time delay is complete, the contacts return to their shelf state for time delay (t) (time on = time-off). This cycle repeats until the power is removed. Terminal B1 is not used in this mode			
4. Signal On-delay and Signal Off-delay	Apply power (U) to timer. When the signal (S) is closed the time delay (t) begins, after the time delay is completed the relay contacts (R) change state. Opening the signal starts the time delay. After the time delay is completed, the contacts return to their shelf state. If the signal is closed or opened before the time delay is complete, the time delay is reset. Contacts return to their shelf state when power is removed.			
5. Signal Off-delay	Apply power (U) to timer. When the signal (S) is closed, the relay contacts (R) change state immediately. When the signal is opened, the time delay (t) begins. If the signal is closed before the time delay is complete, the time delay is reset and the relay remains energized. When the time delay is complete, the contacts return to their shelf state. Contacts return to their shelf state when power is removed.			
6. Signal On One-shot	Apply power (U) to timer. When the signal (S) is closed, the relay contacts (R) change state immediately and the time delay (t) begins. After the time delay begins, opening or closing the signal does not reset the time delay. When the time delay is complete, the contacts return to their shelf state. Contacts return to their shelf state when power is removed.			
7. Signal Off One-shot	Apply power (U) to timer. When the signal (S) is closed and then opened, the relay contacts (R) change state immediately and the time delay (t) begins. After the time delay begins, opening or closing the signal does not reset the time delay. When the time delay is complete, the contacts return to their shelf state. Contacts return to their shelf state when power is removed.			
8. Signal On and Signal Off Watchdog Monitor	Apply power (U) to timer. When the signal (S) is closed, the relay contacts (R) energize immediately and the time delay (t) begins. If the signal is opened before the time delay is complete, the relay remains energized and the time delay is reset. When the time delay is completed, the contacts return to their shelf state. If the signal is opened after the time delay is complete, the relay contacts energize immediately and the same time delay begins. Continuous cycling of the signal at a rate that is faster than the time delay causes the relay contacts to remain energized. Contacts return to their shelf state when power is removed.			

Approximate Dimensions

Approximate dimensions are shown in millimeters (inches). Dimensions are not intended for manufacturing purposes.

Figure 2 - Cat. No. 700-HA Relay

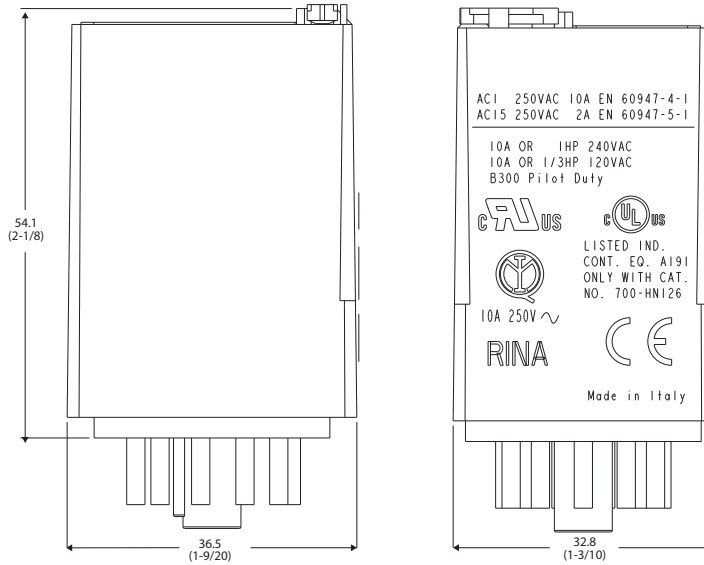
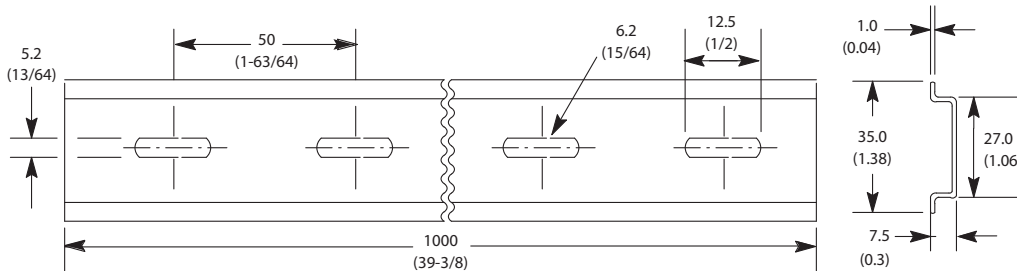
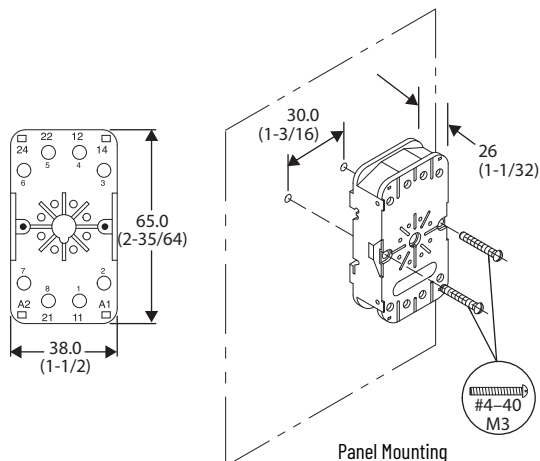


Figure 3 - Cat. No. 199-DR1 DIN Mounting Rail, Series B



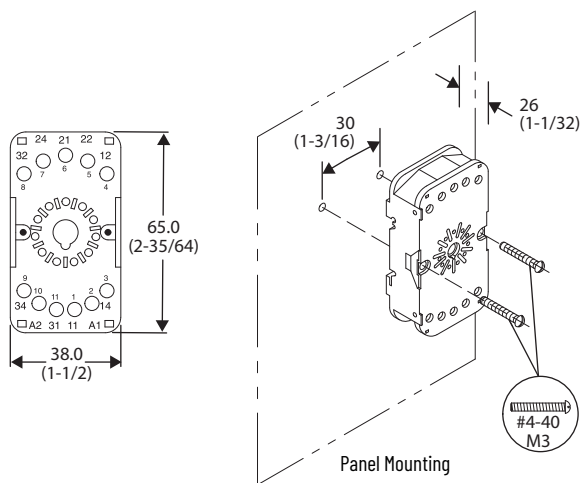
Sockets

Figure 4 - Cat. No. 700-HN100



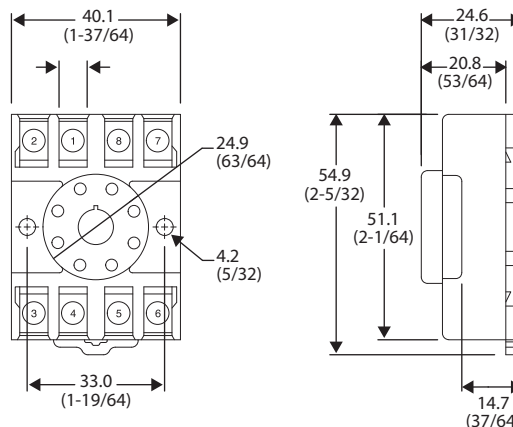
Wire Size: $2 \times 2.5 \text{ mm}^2$
 Single Wire - Up to #12 AWG
 Double Wire - $2 \times 2.5 \text{ mm}^2$ (#2...14 AWG... #20 AWG) (Either Solid or Stranded)
 Strip Length: 9 mm (3/8 in.) - Torque: 0.8 N•m (7 lb•in)

Figure 5 - Cat. No. 700-HN101



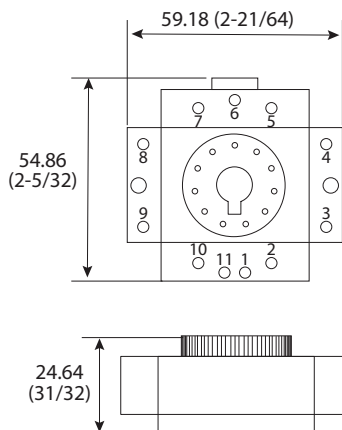
Wire Size: $2 \times 2.5 \text{ mm}^2$
 Single Wire - Up to #12 AWG
 Double Wire - $2 \times 2.5 \text{ mm}^2$ (#2...14 AWG... #20 AWG) (Either Solid or Stranded)
 Strip Length: 9 mm (3/8 in.) - Torque: 0.8 N•m (7 lb•in)

Figure 6 - Cat. No. 700-HN125



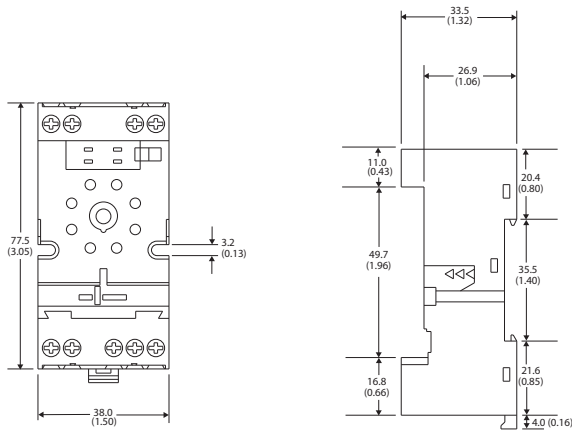
Wire Size: $2 \times 2.5 \text{ mm}^2$
 Single Wire - Up to #12 AWG
 Double Wire - $2 \times 2.5 \text{ mm}^2$ (#2...14 AWG... #20 AWG) (Either Solid or Stranded)
 Strip Length: 9 mm (3/8 in.) - Torque: 0.8 N•m (7 lb•in)

Figure 7 - Cat. No. 700-HN126



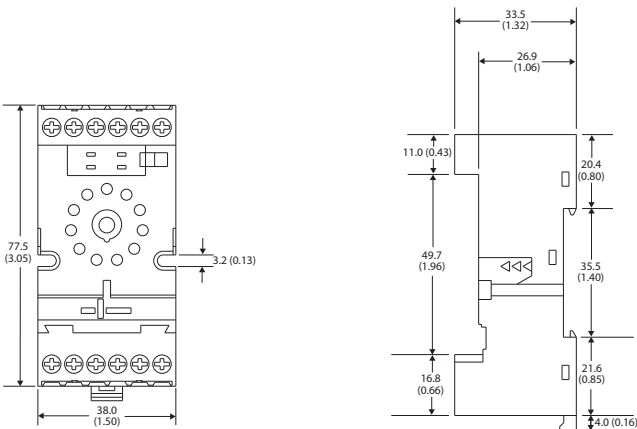
Wire Size: $2 \times 2.5 \text{ mm}^2$
 Single Wire - Up to #12 AWG
 Double Wire - $2 \times 2.5 \text{ mm}^2$ (#2...14 AWG... #20 AWG) (Either Solid or Stranded)
 Strip Length: 9 mm (3/8 in.) - Torque: 0.8 N•m (7 lb•in)

Figure 8 - Cat. No. 700-HN204



Wire Size: $2 \times 2.5 \text{ mm}^2$
 Single Wire - Up to #12 AWG
 Double Wire - $2 \times 2.5 \text{ mm}^2$ (#2...14 AWG... #2...20 AWG) (Either Solid or Stranded)
 Strip Length: 9 mm (3/8 in.) - Torque: 0.8 N•m (7 lb•in)

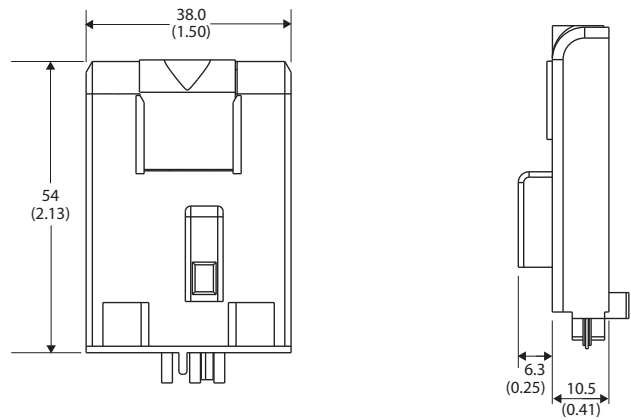
Figure 9 - Cat. No. 700-HN205



Wire Size: $2 \times 2.5 \text{ mm}^2$
 Single Wire - Up to #12 AWG
 Double Wire - $2 \times 2.5 \text{ mm}^2$ (#2...14 AWG... #2...20 AWG) (Either Solid or Stranded)
 Strip Length: 9 mm (3/8 in.) - Torque: 0.8 N•m (7 lb•in)

Timing Module

Figure 10 - Cat. No. 700-HT3



Wire Size: $2 \times 1.5 \text{ mm}^2$ (#2 - 16 AWG...#1-20 AWG) (Either Solid or Stranded)
 Strip Length: 9 mm (3/8 in.) - Torque: 0.8 N•m (7 lb•in)


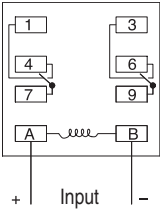
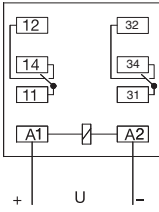
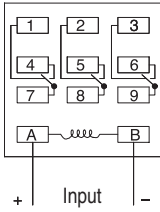
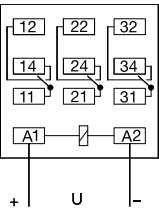
700-HB Square Base Relay

- 15 A contact rating
- DPDT, 3PDT
- Blade-style quick connect /solder terminals (Faston 187 - 4.8 x 0.5 mm)
- Standard ON/OFF flag indicator
- Options: LED, push-to-rest, and manual override



Product Selection





Square Base Relays

Photo	Description	Contact Rating	Wiring Diagrams		Coil Voltage	Cat. No. ⁽¹⁾
			U.S./Canada	International		
	DPDT 2-Pole 2 Form C Single AgCdO Contact	15 A B300			6V AC	700-HB32A06
					12V AC	700-HB32A12
					24V AC	700-HB32A24
					120V AC	700-HB32A1
					240V AC	700-HB32A2
					6V DC	700-HB32Z06
					12V DC	700-HB32Z12
					24V DC	700-HB32Z24
					48V DC	700-HB32Z48
					110V DC	700-HB32Z1
	Sockets	700-HN154	700-HN153	110V DC	700-HB32Z1	
	3PDT 3-Pole 3 Form C Single AgCdO Contact	15 A B300			6V AC	700-HB33A06
					12V AC	700-HB33A12
					24V AC	700-HB33A24
120V AC					700-HB33A1	
240V AC					700-HB33A2	
6V DC					700-HB33Z06	
12V DC	700-HB33Z12					
24V DC	700-HB33Z24					
48V DC	700-HB33Z48					
110V DC	700-HB33Z1					
Sockets	700-HN154	700-HN153	110V DC	700-HB33Z1		

(1) LED Option: Add suffix (-4) to the selected 700-HB Relay Cat. No. For 240V AC Units, add (-4L).
 Push-to-test, Manual Override, and LED Option: Add suffix (-3-4) to the selected 700-HB Relay Cat. No. For 240V AC units, add (-3-4L).
 Push-to-test and Manual Override option: Add suffix (-3) to the selected 700-HB relay.

Accessories




Sockets and DIN Rail

	Description	For Use With	Pkg. Qty.	Cat. No.
	Screw Terminal Socket <ul style="list-style-type: none"> Panel or DIN Rail Mounting Guarded Terminal Construction 11-blade Coil and contact separation Can be used with optional plug-in modules (700-A... accessories, LED, surge suppression, timing modules) 	700-HB relays	10	700-HN153
	Screw Terminal Base Sockets <ul style="list-style-type: none"> Panel or DIN Rail Mounting Open Style Construction 11-blade 	700-HB relays	10	700-HN154
	DIN (#3) symmetrical hat rail <ul style="list-style-type: none"> 35 x 7.5 x 1 m 		10	199-DR1
	Retainer Clip <ul style="list-style-type: none"> Secures relay in socket Order must be for 10 clips or multiples of 10. 	700-HN154 Sockets with 700-HB Relays	10	700-HN156
		700-HN153 Sockets with 700-HB Relays	10	700-HN158









Socket and Retainer Clip Reference

Relay Cat. No.	Socket	Retainer Clip
700-HB	700-HN153	700-HN158
	700-HN154	700-HN156


Timing Modules

Photo	Description	Diagram	Cat. No.
	Timing Module <ul style="list-style-type: none"> On-delay or One-Shot used with sockets that accept plug-in accessory modules Pkg. Qty: 1 	12...24V AC/DC, selectable	700-AT3
		110...125V AC, selectable	700-AT3A1
		230...240V AC, selectable	On-Delay U (A1/A2)  LED & R
One-Shot U (A1/A2)  LED & R			



Timing Modules (Continued)

Photo	Description		Diagram	Cat. No.	
	<p>Multi-Function/Multi-Range Time Module</p> <ul style="list-style-type: none"> Voltage range 12...240V AC 50/60 Hz and 12...240V DC - voltage variation of 85...110% Repeat accuracy of ±1% Reset time <50 ms For use with 700-HB relays using 700-HN153 sockets See 700-HT3 Timing Module Electrical Ratings on page 17 	1. 1 s	0.05...1 s		700-HT3
		2. 10 s	0.5...10 s		
		3. 100 s	5...100 s		
		4. 10 min	0.5...10 min		
		5. 100 min	5...100 min		
		6. 10 hours	0.5...10 h		
		7. 100 hours	5...100 h		
		8. LED Indicator	—	—	

Surge Suppressors

	Description	For Use With	Pkg. Qty.	Cat. No.
	Diode Surge Suppressor	700-HN153 sockets	10	700-ADR
			10	700-ADL1R
			10	700-ADL2R
			10	700-ADL3R
	Varistor Surge Suppressor with LED		10	700-AV1R
			10	700-AV3R
	RC Surge Suppressor		10	700-AR1
			10	700-AR2

Marking Systems

Photo	Description	Pkg. Qty.	Cat. No.
	<p>Relay Identification Snap-in Markers</p> <ul style="list-style-type: none"> Snap-in markers fit on top of product covers Squares slip into molded slot on top of product covers Use with Cat. No. 700-N40 or 700-N41 identification tags 	100	1492-MS5X12
			1492-MS6X9
			1492-MS6X12
			1492-MS8X9
			1492-MS8X12
			1492-MP-Blank
	<p>Pre-printed Identification Tags</p> <ul style="list-style-type: none"> Contains 10 sheets of pre-printed and blank tags Each sheet contains 13 sets of the markings CR...9CR, TR...9TR, M...9M, F, R, IS, and 117 blank tags Tags are peel-off with sticky backing for easy placement on relays 	10	700-N40
	<p>Blank Identification Tags</p> <ul style="list-style-type: none"> contains 10 sheets of blank identification tags for customer specialized printing Each sheet contains 546 blank tags Tags are peel-off with sticky backing for easy placement on relays. 	10	700-N41

Specifications

Table 11 - Electrical Ratings

Attribute			700-HB Relay				
Pilot Duty Rating ⁽¹⁾			NEMA B300				
Rated Thermal Current (I_{th})			15 A - 120V, 240V				
Rated Insulation Voltage (U_i)		IEC	250V				
		UL/CSA	300V				
Contacts	Inductive	Make		Break		Hp	
		▶] [◀		◀] [▶			—
	No. of Poles		2-Pole	3-Pole	2-Pole	3-Pole	
	120V AC		60 A	30 A	6 A	3 A	1/3
	240V AC		30 A	15 A	3 A	1.5 A	1
	General-purpose		15 A, 240V AC				
Resistive		15 A, 30V DC					
Minimum Low Energy Permissible Load			1000 mW; 10V, 10 mA				
Permissible Coil Voltage Variation	Pickup		50 Hz	80...110% of nominal voltage			
			60 Hz	80...110% of nominal voltage			
			DC	80...110% of nominal voltage			
Coil Consumption ±10%	AC Coils	Inrush	50 Hz	3.3VA			
			60 Hz	2.85VA			
		Sealed	50 Hz	2.2VA			
			60 Hz	1.9VA			
	DC Coils		1.3 W				
Max Allowable Leakage		VA	25%				
		W	10%				
Max Contact Resistance			50 MΩ				
Design Specification/Test Requirements	Electrical	Dielectric Withstand Voltage	Pole-to-Pole	2500V			
			Contact to Coil	4000V			

(1) See [NEMA Ratings and Test Values on page 5](#)

Table 12 - Mechanical Ratings

Attribute		700-HB Relay
Degree of Protection (Open Type) IEC 529		IP 40
Mechanical Life Operations (AC/DC)		$> 10 \times 10^6 / 30 \times 10^6$
Switching Frequency Operations		3600/h
Coil Voltages		See page 23
Operating Time	Pickup	20 ms
	Dropout	4 ms
Maximum Operating Rate		4 Ops/s
Vibration	Endurance	5 G
	Operational	1.5 G
Shock	Endurance	50 G
	Operational	15 G

Table 13 - Environmental Ratings

Attribute		700-HB Relay	
Temperature	Operating	[°C]	-40...+70
		[°F]	-40...+158
	Storage	[°C]	-40...+100
		[°F]	-40...+212
Altitude		2000 m (6560 ft)	

Table 14 - Construction

Attribute	700-HB Relay
Insulating Material	Molded High-Dielectric Material
Enclosure	Transparent Dust Cover
Contact Material	AgCdO
Terminal Markings on Socket	In accordance with EN50 0005
Sockets	700-HN153, -HN154

Table 15 - Standards Compliance and Certifications

Attribute	700-HB Relay
Certifications	<ul style="list-style-type: none"> • cURus Recognized (File No. E3125, Guide NLDX2/NLDX8) • cULus Listed when used with 700-HN sockets noted (File No. E3125, Guide NLDX/NLDX7) • CE Marked • CSA Certified • UR Certified (File 229473)
Standards Compliance	<ul style="list-style-type: none"> • UL508 • CSA C22.2 No. 14, • EN 61810-1

Life-load Curves

Figure 11 - Contact life versus AC-1 load at 600 cycles/hour

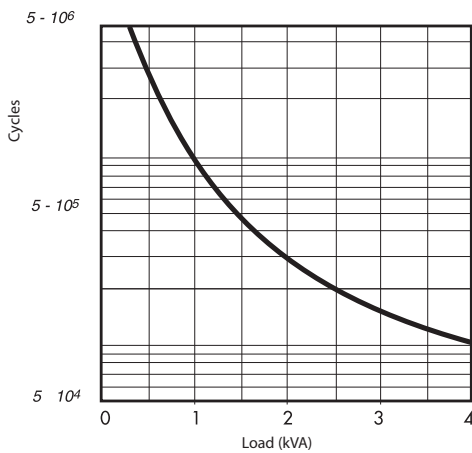


Figure 13 - Load Reduction factor versus cos φ

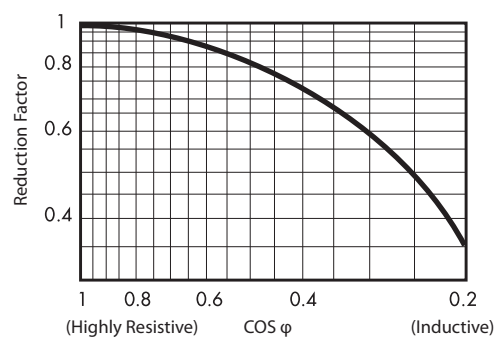
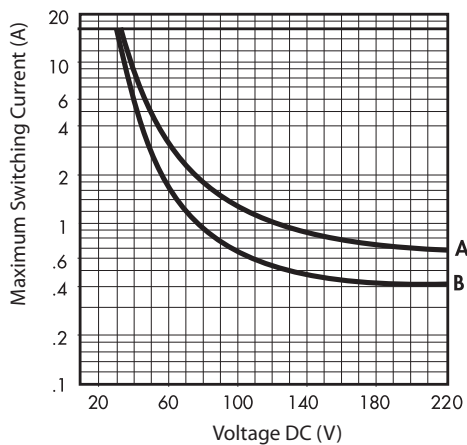


Figure 12 - Breaking capacity for DC-1 load at 600 cycles/hour

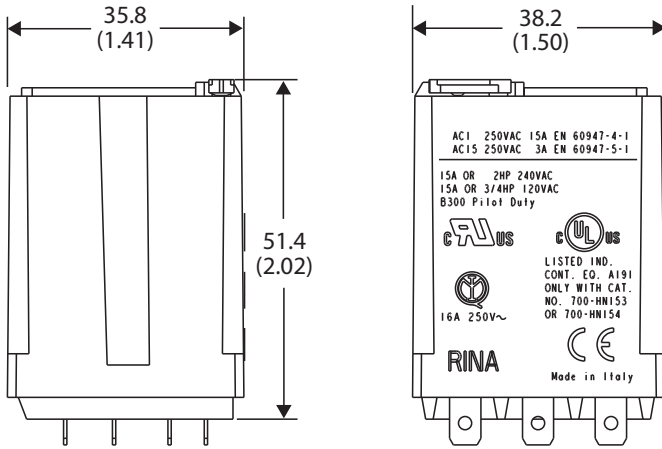


Load applied to one contact.
 A = for N.O. types
 B = other types

Approximate Dimensions

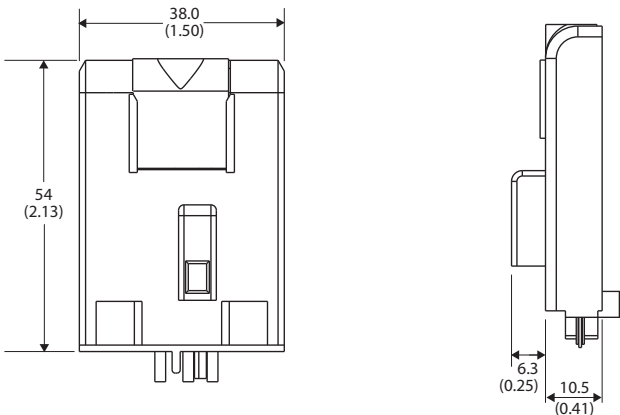
Approximate Dimensions are shown in millimeters (inches). Dimensions are not intended for manufacturing purposes.

Figure 14 - Cat. No. 700-HB Relay



Timing Module

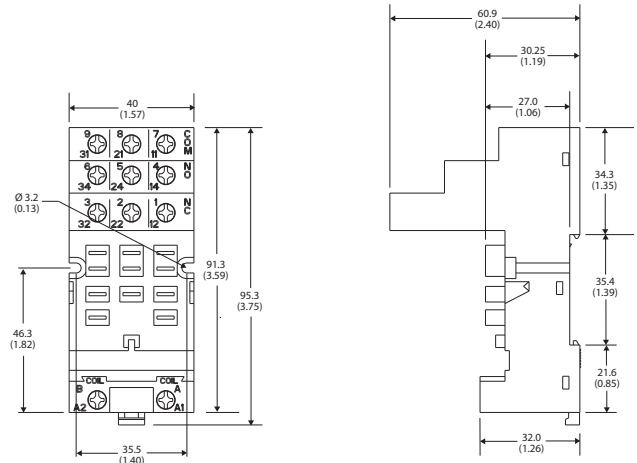
Figure 15 - Cat. No. 700-HT3



Wire Size: 2 x 1.5 mm² (#2...16 AWG...#1...20 AWG) (Either Solid or Stranded)
Strip Length: 9 mm (3/8 in.) - Torque: 0.8 N•m (7 lb•in)

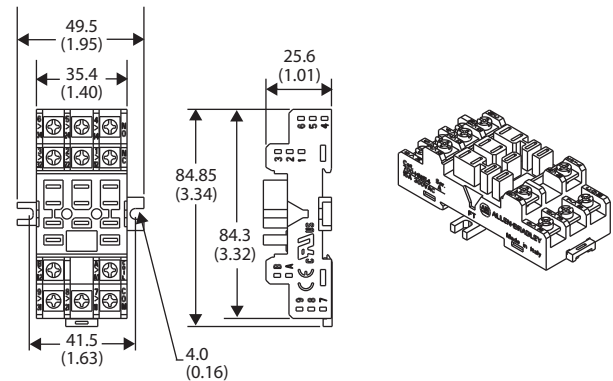
Sockets

Figure 16 - Cat. No. 700-HN153



Wire Size: 2 x 2.5 mm²
Single Wire - Up to #12 AWG
Double Wire - 2 x 2.5 mm² (#14 ...20 AWG) (Either Solid or Stranded)
Strip Length: 9 mm (3/8 in.) - Torque: 0.8 N•m (7 lb•in)

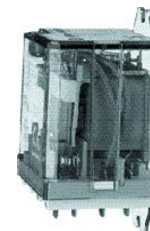
Figure 17 - Cat. No. 700-HN154



Wire Size: 2 x 2.5 mm²
Single Wire - Up to #12 AWG
Double Wire - 2 x 2.5 mm² (#14 ...20 AWG) (Either Solid or Stranded)
Strip Length: 9 mm (3/8 in.) - Torque: 0.8 N•m (7 lb•in)


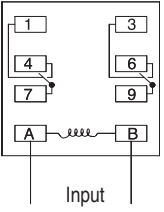
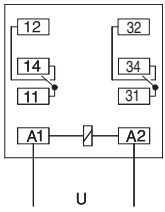
700-HD Flange Mount Square Base Relay

- Flange-mounted/panel-mounted
- 15 A contact rating
- DPDT, 3PDT
- Blade-style quick connect terminals (0.187 x 0.020)
- Solder terminals (no socket required)





Product Selection

Flange Mount Square Base Relays

Photo	Contact Rating		Wiring Diagrams		Coil Voltage	Cat. No.
			U.S./Canada	International		
	DPDT 2-Pole 2 Form C AgCdO Contacts	15 A			6V AC	700-HD32A06
					12V AC	700-HD32A12
					24V AC	700-HD32A24
					120V AC	700-HD32A1
					208V AC	700-HD32A20
					240V AC	700-HD32A2
					6V DC	700-HD32Z06
					12V DC	700-HD32Z12
					24V DC	700-HD32Z24
					48V DC	700-HD32Z48
					110V DC	700-HD32Z1
					6V AC	700-HD33A06
					12V AC	700-HD33A12
					24V AC	700-HD33A24
120V AC	700-HD33A1					
208V AC	700-HD33A20					
240V AC	700-HD33A2					
6V DC	700-HD33Z06					
12V DC	700-HD33Z12					
24V DC	700-HD33Z24					
48V DC	700-HD33Z48					
110V DC	700-HD33Z1					

Accessories

Marking Systems

Photo	Description	Pkg. Qty.	Cat. No.
	Relay Identification Snap-in Markers <ul style="list-style-type: none"> • Snap-in markers fit on top of product covers • Squares slip into molded slot on top of product covers • Use with Cat. No. 700-N40 or 700-N41 identification tags 	100	1492-MS5X12
			1492-MS6X9
			1492-MS6X12
			1492-MS8X9
			1492-MS8X12
			1492-MP-Blank
	Pre-printed Identification Tags <ul style="list-style-type: none"> • Contains 10 sheets of pre-printed and blank tags • Each sheet contains 13 sets of the markings CR...9CR, TR...9TR, M...9M, F, R, 1S, and 117 blank tags • Tags are peel-off with sticky backing for easy placement on relays 	10	700-N40
	Blank Identification Tags <ul style="list-style-type: none"> • contains 10 sheets of blank identification tags for customer specialized printing • Each sheet contains 546 blank tags • Tags are peel-off with sticky backing for easy placement on relays. 	10	700-N41

Specifications

Table 16 - Electrical Ratings

Attribute			700-HD Relay				
Pilot Duty Rating ⁽¹⁾			NEMA B300				
Rated Thermal Current (I_{th})			15 A ⁽²⁾ - 120V, 240V				
Rated Insulation Voltage (U_i)		IEC	250V				
		UL/CSA	300V				
Contacts	Inductive	Make		Break		Hp	
		▶ ◀		◀ ▶		—	
	No. of Poles		2-Pole	3-Pole	2-Pole	3-Pole	
	120V AC		60 A	30 A	6 A	3 A	3/4
	240V AC		30 A	15 A	3 A	1.5 A	2
	General-purpose		15 A, 240V AC				
Resistive		15 A, 30V DC					
Minimum Low Energy Permissible Load			1000 mW; 10V, 10 mA				
Permissible Coil Voltage Variation	Pickup		50 Hz	80...110% of nominal voltage			
			60 Hz	80...110% of nominal voltage			
			DC	80...110% of nominal voltage			
Coil Consumption ±10%	AC Coils	Inrush	50 Hz	3.3VA			
			60 Hz	2.85VA			
		Sealed	50 Hz	2.2VA			
			60 Hz	1.9VA			
	DC Coils		1.3 W				
Must Dropout Voltage		V AC	20% of nominal voltage				
		V DC	10% of nominal voltage				
Max Contact Resistance			50 MΩ				
Design Specification/Test Requirements	Electrical	Dielectric Withstand Voltage	Pole-to-Pole	2500V			
			Contact to Coil	4000V			

(1) See [NEMA Ratings and Test Values on page 5](#)

(2) 3-pole relays have a 20 A maximum total current rating for all three poles.

Table 17 - Mechanical Ratings

Attribute		700-HD Relay
Degree of Protection (Open Type) IEC 529		IP 40
Mechanical Life Operations (AC/DC)		$> 10 \times 10^6 / 30 \times 10^6$
Switching Frequency Operations		3600/h
Coil Voltages		See page 29
Operating Time	Pickup	20 ms
	Dropout	4 ms
Maximum Operating Rate		4 Ops/s
Vibration	Endurance	5 G
	Operational	2.5 G
Shock	Endurance	50 G
	Operational	9 G

Table 18 - Environmental Ratings

Attribute		700-HD Relay	
Temperature	Operating	[°C]	-40...+70
		[°F]	-40...+158
	Storage	[°C]	-40...+100
		[°F]	-40...+212
Altitude		2000 m (6560 ft)	

Table 19 - Construction

Attribute	700-HD Relay
Insulating Material	Molded High-Dielectric Material
Enclosure	Transparent Dust Cover
Contact Material	Silver Cadmium Oxide
Terminal Markings on Socket	In accordance with EN50 0005

Table 20 - Standards Compliance and Certifications

Attribute	700-HD Relay
Certifications	<ul style="list-style-type: none"> cURus Recognized (File No. E3125, Guide NLDX2/NLDX8) CE Marked CSA Certified UR Certified (File 229473)
Standards Compliance	<ul style="list-style-type: none"> UL508 CSA C22.2 No. 14, EN 61810-1

Life-load Curves

Figure 18 - Contact life versus AC-1 load at 600 cycles/hour

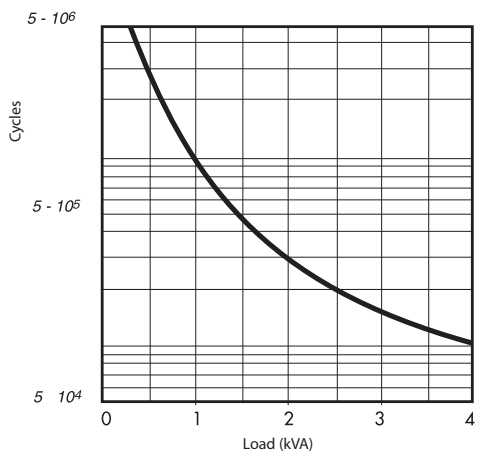


Figure 19 - Breaking capacity for DC-1 load at 600 cycles/hour

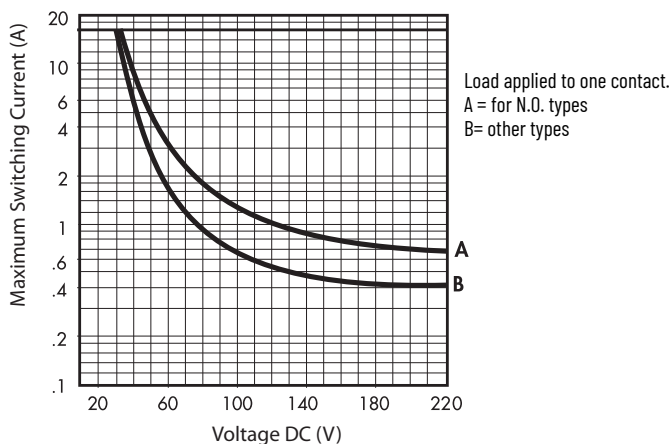
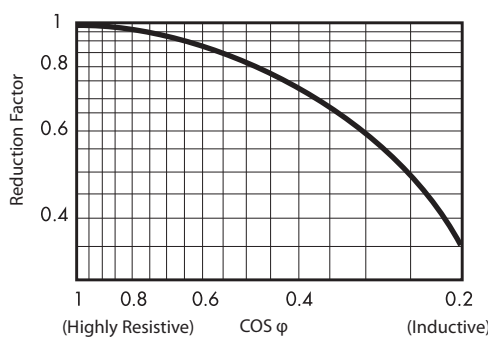


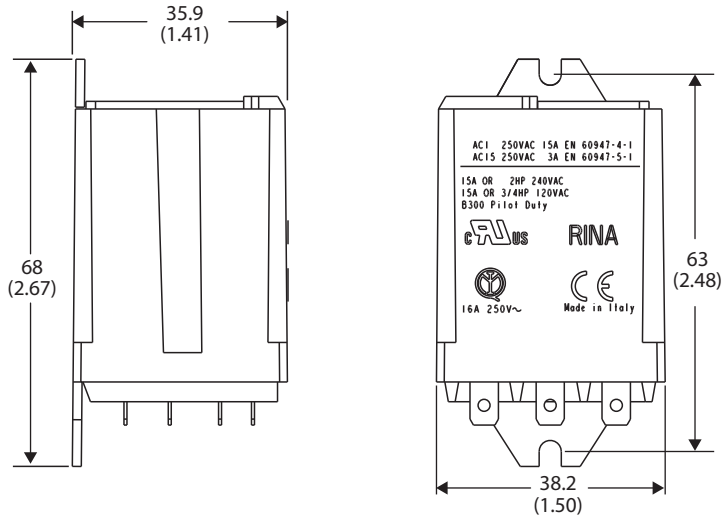
Figure 20 - Load Reduction factor versus cos φ



Approximate Dimensions

Approximate dimensions are shown in millimeters (inches). Dimensions are not intended for manufacturing purposes.

Figure 21 - Cat. No. 700-HD Relay




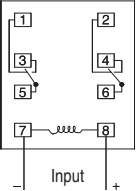
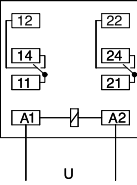

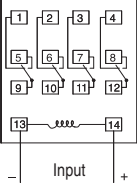
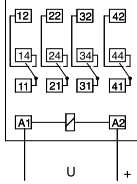
700-HF Square Base Relay

- 12 A contact rating
- DPDT, 4PDT
- Plug-in quick connect/solder terminals
- Options: LED, push-to-test manual override operator
- Blade size: 4.8 x 0.5 mm (0.19 x 0.02 in.)



Product Selection







Square Base Relays

Photo	Description	Contact Rating	Wiring Diagrams		Coil Voltage	Cat. No. ⁽¹⁾
			U.S./Canada	International		
	DPDT 2-pole 2 Form C AgCdO Contacts	12 A			6V AC	700-HF32A06
					12V AC	700-HF32A12
					24V AC	700-HF32A24
					120V AC	700-HF32A1
					240V AC	700-HF32A2
					6V DC	700-HF32Z06
					12V DC	700-HF32Z12
					24V DC	700-HF32Z24
					48V DC	700-HF32Z48
				Socket		700-HN116 700-HN262
	4PDT 4-pole 4 Form C AgCdO Contact	12 A			6V AC	700-HF34A06
					12V AC	700-HF34A12
					24V AC	700-HF34A24
					120V AC	700-HF34A1
					240V AC	700-HF34A2
					6V DC	700-HF34Z06
					12V DC	700-HF34Z12
					24V DC	700-HF34Z24
					48V DC	700-HF34Z48
				Socket		700-HN139 700-HN264

(1) Pilot Light Option: Add suffix (-4) to the selected 700-HF Relay Cat. No. For 240V AC Units, add (-4L).
 Manual Operator and LED Option: Add suffix (-3-4) to the selected 700-HF Relay Cat. No. For 240V AC units, add (-3-4L).

Accessories


Sockets and DIN Rail

	Description	For Use With	Pkg. Qty.	Cat. No.
	Screw Terminal Socket <ul style="list-style-type: none"> Panel or DIN Rail Mounting 8-blade miniature socket 	700-HF DPDT relays	10	700-HN116
	Screw Terminal Base Sockets <ul style="list-style-type: none"> Panel or DIN Rail Mounting Guarded Terminal Construction 8-blade socket Can be used with optional plug-in modules (700-A... accessories, LED, surge suppression, timing modules) 	700-HF DPDT relays	10	700-HN262
	Screw Terminal Socket <ul style="list-style-type: none"> Panel or DIN Rail Mounting Guarded Terminal Construction 14-blade 	4PDT 700-HF relays	10	700-HN139
	Screw Terminal Socket <ul style="list-style-type: none"> Panel or DIN Rail Mounting Guarded Terminal Construction 14-blade Coil and contact separation Can be used with optional plug-in modules (700-A... accessories, LED, surge suppression, timing modules) 	4PDT 700-HF relays	10	700-HN264
	DIN (#3) symmetrical hat rail <ul style="list-style-type: none"> 35 x 7.5 x 1 m 		10	199-DR1
	Retainer Clip <ul style="list-style-type: none"> Secures relay in socket Order must be for 10 clips or multiples of 10. 	Cat. Nos. 700-HN116, 700-HN262 Sockets with 700-HF DPDT Relays	10	700-HN114
		Cat. Nos. 700-HN139 and -HN264 Sockets with 700-HF 4PDT Relays	10	700-HN266


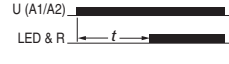

Socket and Retainer Clip Reference

Relay Cat. No.	Socket	Retainer Clip
700-HF32	700-HN116	700-HN114
	700-HN262	
700-HF34	700-HN139	700-HN266
	700-HN264	


Surge Suppressors

	Description	For Use With	Pkg. Qty.	Cat. No.
	Diode Surge Suppressor	sockets that accept plug-in accessory modules	10	700-ADL1
			10	700-ADL2
			10	700-ADL3
	Varistor Surge Suppressor with LED		10	700-AV1R
			10	700-AV3R
	RC Surge Suppressor		10	700-AR1
10		700-AR2		

Timing Modules

Photo	Description	Diagram	Cat. No.	
	Timing Module <ul style="list-style-type: none"> On-delay or One-Shot used with sockets that accept plug-in accessory modules Pkg. Qty: 1 	On-Delay  One-Shot 	12...24V AC/DC, selectable	
			110...125V AC, selectable	700-AT3
			230...240V AC, selectable	700-AT3A1
			700-AT3A2	

Marking Systems

Photo	Description	Pkg. Qty.	Cat. No.
	Pre-printed Identification Tags <ul style="list-style-type: none"> Contains 10 sheets of pre-printed and blank tags Each sheet contains 13 sets of the markings CR...9CR, TR...9TR, M...9M, F, R, 1S, and 117 blank tags Tags are peel-off with sticky backing for easy placement on relays 	10	700-N40
	Blank Identification Tags <ul style="list-style-type: none"> contains 10 sheets of blank identification tags for customer specialized printing Each sheet contains 546 blank tags Tags are peel-off with sticky backing for easy placement on relays. 	10	700-N41

Specifications

Table 21 - Electrical Ratings

Attribute			700-HF Relay		
			2-Pole	4-Pole	
Pilot Duty Rating ⁽¹⁾			NEMA B300		
Rated Thermal Current (I_{th})			15 A - 120V, 240V		
Rated Insulation Voltage (U_i)		IEC	250V		
		UL/CSA	300V		
Contacts	Inductive V AC	230V AC	AC-15 @ 700 VA		
			AC-1 @ 3000 VA		
	VDC	120V AC	1 Hp @ 240V AC		
			1/2 Hp @ 120V AC		
		DC-1	12 A @ 30V DC		
			0.5 A @ 110V DC		
Resistive	AC	12 A @ 250V AC (per pole)			
	DC	12 A @ 30V DC (per pole)			
Operating Range		AC	80...110% of nominal voltage		
		DC	80...110% of nominal voltage	85...110% of nominal voltage	
Rated Power		AC (50 Hz)	1.5 VA	2 VA	
		DC	1 W	1.3 W	
Holding Voltage		AC	80% of nominal voltage		
		DC	60% of nominal voltage		
Must Drop Out Voltage		AC	20% of nominal voltage		
		DC	10% of nominal voltage		
Insulation Voltage		60 Hz	250V AC		
Design Specification/Test Requirements	Electrical	Dielectric Withstand Voltage	Pole-to-Pole	2500V AC	
			Contact to Coil	2500V AC	

(1) See [NEMA Ratings and Test Values on page 5](#)

Table 22 - Mechanical Ratings

Attribute			700-HF Relay	
			2-Pole	4-Pole
Degree of Protection (Open Type) IEC 529			IP 40	
Mechanical Life Operations (AC/DC)			20 x 10 ⁶	
Switching Frequency Operations			3600/h	
Coil Voltages			See page 33	
Operating Time	Pickup		8 ms	10 ms
	Dropout		3 ms	4 ms
Maximum Operating Rate			4 Ops/s	
Vibration			15 G	
Shock			15 G	

Table 23 - Environmental Ratings

Attribute			700-HF Relay	
Temperature	Operating	[°C]	-40...+70	
		[°F]	-40...+158	
	Storage	[°C]	-50...+180	
		[°F]	-89...+176	
Altitude			2000 m (6560 ft)	

Table 24 - Construction

Attribute		700-HF Relay
Insulating Material		Molded High-Dielectric Material
Enclosure		Transparent Dust Cover
Contact Material		Silver Cadmium Oxide
Terminal Markings on Socket		In accordance with EN50 0005
Sockets	8-Blade (DPDT)	700-HN116, -HN262
	14-Blade (4PDT)	700-HN139 -HN264

Table 25 - Standards Compliance and Certifications

Attribute	700-HF Relay
Certifications	<ul style="list-style-type: none"> • UL Recognized (File No. E3125, Guide NLDX2/NLDX8) • UL Listed when used with 700-HN sockets noted (File No. E3125, Guide NLDX/NLDX7) • CE Marked • CSA Certified (File No. 229473) • LR Certified • RINA Certified • IMQ Certified
Standards Compliance	<ul style="list-style-type: none"> • UL508 • CSA C22.2 No. 14, • EN 61810-1

Approximate Dimensions

Approximate Dimensions are shown in millimeters (inches). Dimensions are not intended to be used for manufacturing purposes.

Figure 22 - Cat. No. 700-HF Relay (DPDT)

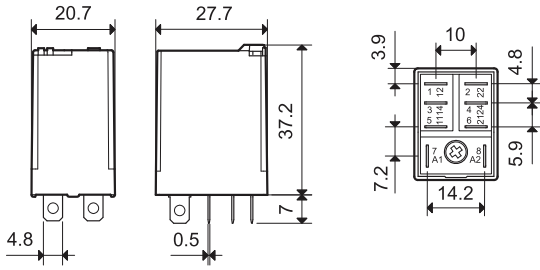
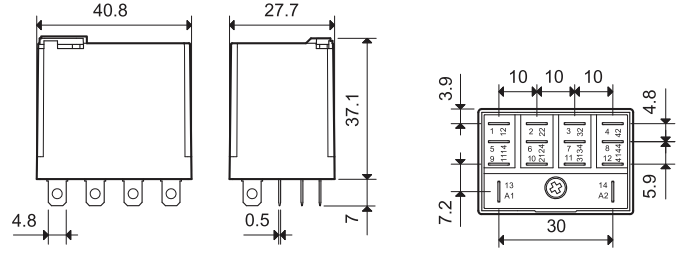
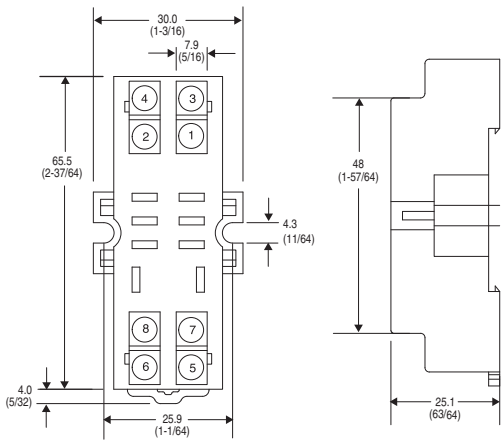


Figure 23 - Cat. No. 700-HF Relay (4PDT)



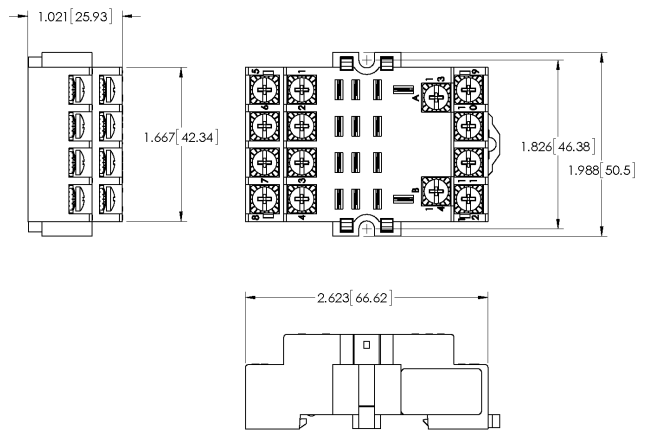
Sockets

Figure 24 - Cat. No. 700-HN116



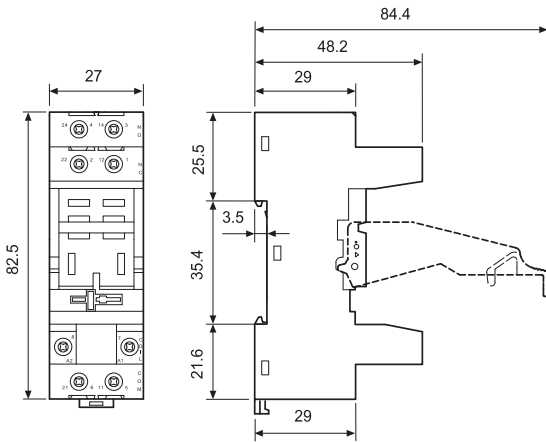
Wire Size: 2 x 2.5 mm²
 Single Wire - Up to #12 AWG
 Double Wire - 2 x 2.5 mm² (#2...14 AWG... #2...20 AWG) (Either Solid or Stranded)
 Strip Length: 9 mm (3/8 in.) - Torque: 0.8 N·m (7 lb·in)

Figure 26 - Cat. No. 700-HN139



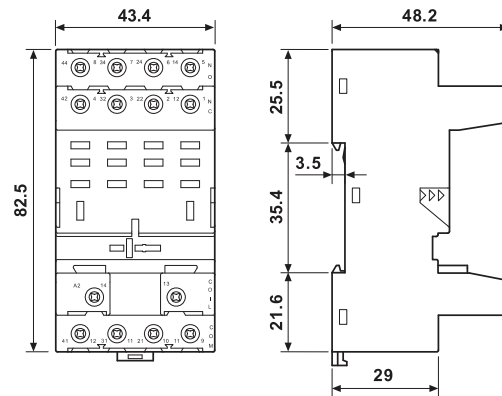
Wire Size: 2 x 2.5 mm²
 Single Wire - Up to #12 AWG
 Double Wire - 2 x 2.5 mm² (#2...14 AWG... #2...20 AWG) (Either Solid or Stranded)
 Strip Length: 9 mm (3/8 in.) - Torque: 0.8 N·m (7 lb·in)

Figure 25 - Cat. No. 700-HN262



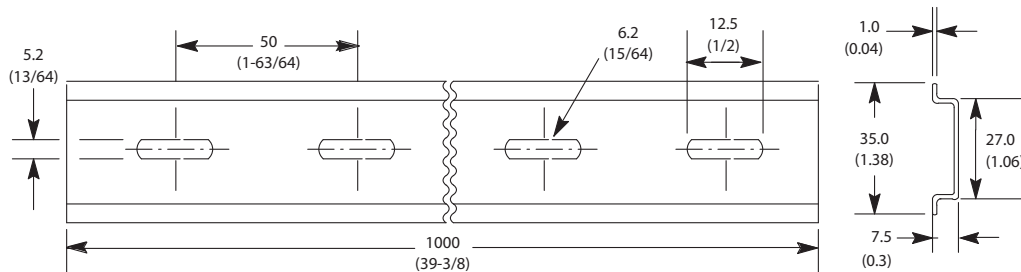
Wire Size: Solid - 1 x 6 / 2 x 2.5 mm²
 1 x 10 / 2 x 14 AWG
 Stranded - 1 x 4 / 2 x 2.5 mm²
 1 x 12 / 2 x 14 AWG
 Strip Length: 9 mm (3/8 in.) - Torque: 0.8 N·m (7 lb·in)
 300V AC, 12 A, 50 °C (122 °F)

Figure 27 - Cat. No. 700-HN264



Wire Size: Solid - 1 x 6 / 2 x 2.5 mm²
 1 x 10 / 2 x 14 AWG
 Stranded - 1 x 4 / 2 x 2.5 mm²
 1 x 12 / 2 x 14 AWG
 Strip Length: 9 mm (3/8 in.) - Torque: 0.8 N·m (7 lb·in)
 300V AC, 10 A, 70 °C (158 °F)

Figure 28 - Cat. No. 199-DR1 DIN Mounting Rail, Series B



700-HC Miniature Ice Cube Relay

- 7 or 10 A contact ratings
- 2PDT or 4PDT
- Standard ON/OFF flag indicator
- Blade-style terminals (2.0 x 0.5 mm)
- Choice of standard silver nickel contacts, or silver nickel with gold-plated contacts for low-energy applications
- Options: LED, push-to-test with manual override option
- Tungsten UL Approvals
 - 4-Pole: 5 A @ 24V DC
 - 2-Pole: 10 A @ 24V DC



Product Selection






Miniature Ice Cube Relays

Photo	Contact Rating		Wiring Diagrams		Coil Voltage	Cat. No. ⁽¹⁾	
			U.S./Canada	International			
	2PDT 2-Pole 2 Form C Contacts: 10 A = AgNi Contacts	10 A C300 R300 Low energy rating; (10V, 10 mA) 100 mW			12V DC	700-HC22Z12	
						24V DC	700-HC22Z24
						24V AC	700-HC22A24
						120V AC	700-HC22A1
				700-HN128	700-HN103 700-HN104	240V AC	700-HC22A2
		4PDT 4-Pole 4 Form C Contacts: 7 A = AgNiAu Gold Plated Contacts	7 A Low energy rating; (5V, 10 mA or 25V, 2 mA) 50 mW			6V AC	700-HC14A06
						12V AC	700-HC14A12
						24V AC	700-HC14A24
						120V AC	700-HC14A1
						240V AC	700-HC14A2
						6V DC	700-HC14Z06
						12V DC	700-HC14Z12
						24V DC	700-HC14Z24
						48V DC	700-HC14Z48
						110V DC	700-HC14Z1
	4PDT 4-Pole 4 Form C Contacts: 7 A = AgNi Silver Contacts	7 A C300 R300 Low energy rating; (10V, 10 mA) 100 mW			6V AC	700-HC24A06	
					12V AC	700-HC24A12	
					24V AC	700-HC24A24	
					120V AC	700-HC24A1	
					240V AC	700-HC24A2	
					6V DC	700-HC24Z06	
					12V DC	700-HC24Z12	
	24V DC	700-HC24Z24					
					48V DC	700-HC24Z48	
			700-HN128	700-HN104	110V DC	700-HC24Z1	

(1) LED Option: Add suffix (-4) to the selected 700-HC Relay catalog number. For 240V AC Units, add (-4L).
 Push-to-test, Manual Override, and LED Option: Add suffix (-3-4) to the selected 700-HC catalog number. For 240V AC Units, add (-3-4L).
 Push-to-test and Manual Override option: Add suffix (-3) to the selected 700-HC relay catalog number.

Accessories

Sockets and DIN Rail


	Description	For Use With	Pkg. Qty.	Cat. No.	
	<ul style="list-style-type: none"> Guarded Terminal Construction 	700-HC Relays	10	700-HN103	
	Screw Terminal Socket <ul style="list-style-type: none"> Panel or DIN Rail Mounting $I_{th} = 10$ A per pole 14-blade miniature socket 	<ul style="list-style-type: none"> Guarded Terminal Construction Coil and contact separation Can be used with optional plug-in modules (700-A__ accessories, LED, surge suppression, timing modules) 	700-HC Relays	10	700-HN104
	<ul style="list-style-type: none"> Open-Style Construction 	700-HC Relay	10	700-HN128	
	DIN (#3) symmetrical hat rail <ul style="list-style-type: none"> 35 x 7.5 x 1 m 		10	199-DR1	
	Retainer Clip <ul style="list-style-type: none"> Secures relay in socket⁽¹⁾ Order must be for 10 clips or multiples of 10. 	Cat. Nos. 700-HN103, -HN104 and -HN128 Sockets with 700-HC Relays	10	700-HN114	
	Plastic Retainer and Ejection Lever <ul style="list-style-type: none"> Built-in ability to accept 1492 Snap-in Markers 	700-HN104 Sockets for 700-HC relays	10	700-HN124	

(1) See 700-HC Miniature Square Base Relay, Socket, and Retainer Clip Reference Chart.






Socket and Retainer Clip Reference

Relay Cat. No.	Socket	Retainer Clip
700-HC	700-HN103	700-HN114
	700-HN128	700-HN114
	700-HN104	700-HN114
		700-HN124


Surge Suppressors

	Description	For Use With	Pkg. Qty.	Cat. No.
	Diode Surge Suppressor	sockets that accept plug-in accessory modules	10	700-ADL1
			10	700-ADL2
			10	700-ADL3
	Varistor Surge Suppressor with LED		10	700-AV1R
			10	700-AV3R
	RC Surge Suppressor		10	700-AR1
	10	700-AR2		

Timing Modules

Photo	Description		Diagram	Cat. No.
 <p>Timing Module</p> <ul style="list-style-type: none"> On-delay or One-Shot used with sockets that accept plug-in accessory modules Pkg. Qty: 1 	12...24V AC/DC, selectable	110...125V AC, selectable	On-Delay U (A1/A2)  LED & R 	700-AT3
	230...240V AC, selectable			One-Shot U (A1/A2)  LED & R 

Marking Systems

Photo	Description	Pkg. Qty.	Cat. No.
	Pre-printed Identification Tags <ul style="list-style-type: none"> Contains 10 sheets of pre-printed and blank tags Each sheet contains 13 sets of the markings CR...9CR, TR...9TR, M...9M, F, R, 1S, and 117 blank tags Tags are peel-off with sticky backing for easy placement on relays 	10	700-N40
	Blank Identification Tags <ul style="list-style-type: none"> contains 10 sheets of blank identification tags for customer specialized printing Each sheet contains 546 blank tags Tags are peel-off with sticky backing for easy placement on relays. 	10	700-N41

Specifications

Table 26 - Electrical Ratings

Attribute			700-HC Relay					
			Cat. No. 700-HC_4			Cat. No. 700-HC22		
Pilot Duty Rating ⁽¹⁾			NEMA B300					
Rated Thermal Current (I_{th})			7 A and 10 A					
Rated Insulation Voltage (U_i)			IEC		250V			
			UL/CSA		300V			
Contacts	Inductive		Make	Break	Hp	Make	Break	Hp
			► ◄	◄ ►	—	► ◄	◄ ►	—
	120V AC		15 A	1.5 A	1/8	15 A	1.5 A	1/3
	240V AC		7.5 A	0.75 A	1/3	7.5 A	0.75 A	3/4
	General-purpose		7 A, 277V AC			10 A, 277V AC		
Resistive		7 A, 30V DC			10 A, 24V DC			
Minimum Low Energy Permissible Load			Silver Contacts		100 mW (10V, 10 mA)			
			Gold Contacts		50 mW (5V, 10 mA, or 25V, 2 mA)			
Permissible Coil Voltage Variation	Pickup		50 Hz	80...110% of nominal voltage				
			60 Hz	80...110% of nominal voltage				
			DC	80...110% of nominal voltage				
	Must Drop Out		AC	20% of nominal voltage				
			DC	10% of nominal voltage				
Coil Consumption $\pm 10\%$	AC Coils	Inrush	50 Hz	2.2VA				
			60 Hz	1.6VA				
		Sealed	50 Hz	1.3VA				
			60 Hz	1.1VA				
	DC Coils		1.0 W					
	Max Allowable Leakage			VA	20% (AC)			
W				10% (DC)				
Max Contact Resistance			50 M Ω					
Design Specification/Test Requirements	Electrical	Dielectric Withstand Voltage	Pole-to-Pole	2000V				
			Contact to Coil	2000V				
		Electrical Life (Cycles)	100,000 min					

(1) See [NEMA Ratings and Test Values on page 5](#)

Table 27 - Mechanical Ratings

Attribute		700-HC Relay
Degree of Protection (Open Type) IEC 529		IP 20 (Guarded Terminal Sockets)
Mechanical Life Operations (AC/DC)		20 x 10 ⁶ / 50 x 10 ⁶
Switching Frequency Operations		1800/h
Coil Voltages		See page 40
Operating Time	Pickup	10 ms
	Dropout	3 ms
Maximum Operating Rate		8 Ops/s
Bounce Time	2-pole	1 ms N.O./4 ms N.C
	3-pole	1 ms N.O./6 ms N.C
	4-pole	2 ms N.O./4 ms N.C
Vibration	5...55 Hz	15 G N.O./15 G N.C.
Shock		16 G
Power Lost to the Environment	without contact current	1 W
	with rated current	3 W (2-pole)
Recommended distance between relays mounted on PCB		≥ 5 mm

Table 28 - Environmental Ratings

Attribute			700-HC Relay
Temperature	Operating	[°C]	-30...+55
		[°F]	-22...+131
	Storage	[°C]	-55...+85
		[°F]	-67...+185
Altitude			2000 m (6560 ft)

Table 29 - Construction

Attribute		700-HC Relay
Insulating Material		Molded High-Dielectric Material
Enclosure		Transparent Dust Cover
Contact Material	700-HC2	AgNi
	700-HC1	AgNi + 5 µm AlI
Terminal Markings on Socket		In accordance with EN50 0005
Sockets	8-Pin	700-HN103, -HN128, -HN104

Table 30 - Standards Compliance and Certifications

Attribute	700-HC Relay
Certifications	<ul style="list-style-type: none"> • cURus Recognized (File No. E14843, Guide NRNT2/NRNT8) • cULus Listed when used with 700- HN103, -HN104, and -HN128 sockets (File No. E14843, Guide NRNT/NRNT7) • CE Marked • LR Certified
Standards Compliance	<ul style="list-style-type: none"> • UL508 • CSA C22.2 No. 14, • EN 61810-1

Approximate Dimensions

Approximate dimensions are shown in millimeters (inches). Dimensions are not intended for manufacturing purposes.

Figure 29 - Cat. No. 700-HC Relay, 2-Pole

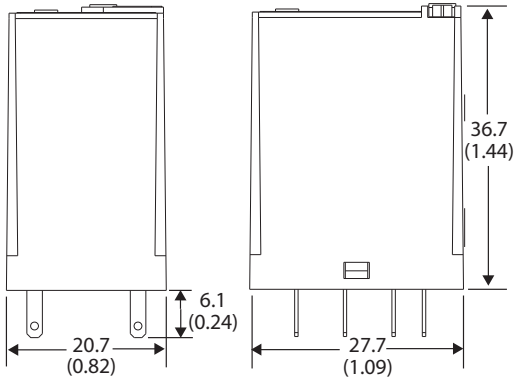
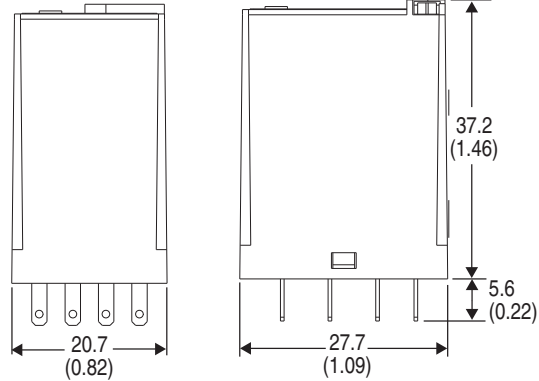
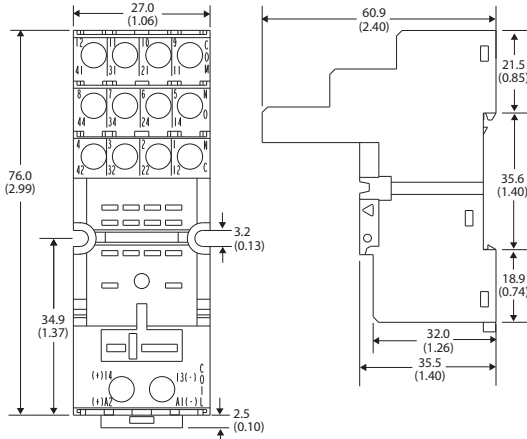


Figure 30 - Cat. No. 700-HC Relay, 4-Pole



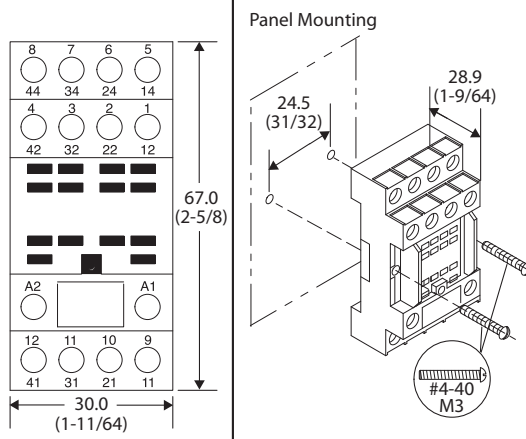
Sockets

Figure 31 - Cat. No. 700-HN104



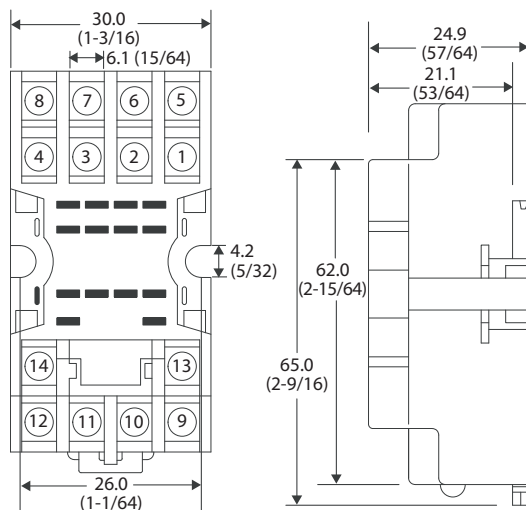
Wire Type: solid or stranded, Cu only
 Single Wire - 0.2...2.5 mm² (#24...14 AWG)
 Double Wire - 2 x 0.2...2.5 mm² (#24...14 AWG) (Either Solid or Stranded)
 Strip Length: 7 mm (9/32 in.) - Torque: 0.5 N·m (4.4 lb·in)

Figure 32 - Cat. No. 700-HN103



Wire Size - 2 x 1.5 mm² (#24...14 AWG)
 Double Wire - 2 x 0.2...2.5 mm² (#2...16...#1...20 AWG) (Either Solid or Stranded)
 Strip Length: 9 mm (3/8 in.) - Torque: 0.8 N·m (7 lb·in)

Figure 33 - Cat. No. 700-HN128




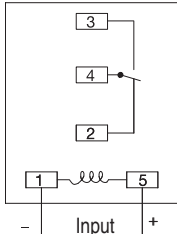
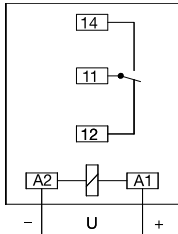

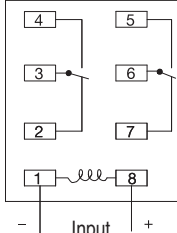
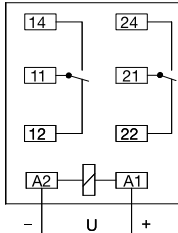
700-HK Slim Line Relay

- 8 A/16 A contact ratings
- Retainer clip with sockets
- Standard ON/OFF flag indicator
- Relay faceplate accepts optional Bulletin1492 snap-in markers
- Options: LED, push-to-test and manual override, socket-mounted surge suppressor module, or timer module
- DPDT/SPDT
- Plug-in blade-style terminals (2.5 x 0.5 mm)
- Maximum duty version available
- Choice of standard silver/nickel contacts or silver/nickel with gold plated contacts



Product Selection









Slim Line Relays

Photo	Description	Contact Rating	Wiring Diagrams		Coil Voltage	Cat. No. ⁽¹⁾
			U.S./Canada	International		
	SPDT 1-Pole 1 Form C AgNi Contacts	16 A			6V AC	700-HK36A06
					12V AC	700-HK36A12
					24V AC	700-HK36A24
					120V AC	700-HK36A1
					240V AC	700-HK36A2
					6V DC	700-HK36Z06
					12V DC	700-HK36Z12
					24V DC	700-HK36Z24
			48V DC	700-HK36Z48		
	Socket		700-HN121, 700-HN221, 700-HN223	700-HN121, 700-HN221, 700-HN223	110V DC	700-HK36Z1
	DPDT 2-Pole 2 Form C AgNi Contacts	8 A			6V AC	700-HK32A06
					12V AC	700-HK32A12
					24V AC	700-HK32A24
					120V AC	700-HK32A1
					240V AC	700-HK32A2
					6V DC	700-HK32Z06
					12V DC	700-HK32Z12
					24V DC	700-HK32Z24
			48V DC	700-HK32Z48		
	Socket		700-HN122, 700-HN222, 700-HN224	700-HN122, 700-HN222, 700-HN224	110V DC	700-HK32Z1


(1) Pilot Light: Add suffix (-4) to the selected 700-HK Relay catalog number except for the 240V AC units, add (-4L).
 Manual Operator and LED: Add suffix (-3-4) to the selected 700-HK Relay catalog number. For 240V AC Units, add (-3-4L).
 AgNi Contact with Gold plating: Replace "3" with "X" on catalog number. For example, if catalog number 700-HK36A1 is required with gold plating, the new catalog number is 700-HKX6A1.
 For high inductive, Tungsten, or Capacitive load applications, replace the "3" with a "M" in the catalog number. Only available in a SPDT configuration and with 24V DC, 120V AC, or 240V AC coil voltages.

Accessories


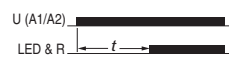
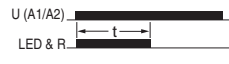
Sockets and Adapters

	Description	For Use With	Pkg. Qty.	Cat. No.	
	Screw Terminal Socket • Panel or DIN Rail Mounting • 5-blade miniature socket	<ul style="list-style-type: none"> • 10 A rating • Accepts forked lug conductors • Includes retainer clip 	1-pole 700-HK relays	10	700-HN121
		<ul style="list-style-type: none"> • 16 A rating • Retainer clips packaged separately with socket • Guarded terminal construction • Compatible with optional plug-in module accessories. 	1-pole 700-HK relays	10	700-HN221
	Spring Clamp Terminal Socket • Panel or DIN Rail Mounting • 5-blade miniature socket		1-pole 700-HK relays	10	700-HN223
	Screw Terminal Socket • Panel or DIN Rail Mounting • 8-blade miniature socket	<ul style="list-style-type: none"> • 5 A rating • Accepts forked lug conductors • Includes retainer clip 	2-pole 700-HK relays	10	700-HN122
		<ul style="list-style-type: none"> • 8 A rating • Retainer clips packaged separately with socket • Guarded terminal construction • Compatible with optional plug-in module accessories. 	2-pole 700-HK relays	10	700-HN222
	Spring Clamp Terminal Socket • Panel or DIN Rail Mounting • 8-blade miniature socket		2-pole 700-HK relays	10	700-HN224
	8-Way Jumper • Can be cut to required length • 10 A rating @ 250V	Red	Cat. Nos. 700-HN221, 700-HN222 sockets	1	700-HN180R
		Grey			700-HN180G
		Blue			700-HN180B
	DIN (#3) symmetrical hat rail • 35 x 7.5 x 1 m			10	199-DR1




Surge Suppressors

	Description	For Use With	Pkg. Qty.	Cat. No.	
	Diode Surge Suppressor	• Voltage Range: 6...220V DC	10	700-ADR	
		• Voltage Range: 6...24V DC	10	700-ADL1R	
		• Voltage Range: 28...60V DC	10	700-ADL2R	
		• Voltage Range: 110...220V DC	10	700-ADL3R	
	Varistor Surge Suppressor with LED	• Voltage Range: 6...24V AC	Cat. Nos. 700-HN204 and 700-HN205 sockets	10	700-AV1R
		• Voltage Range: 110...240V AC		10	700-AV3R
		• Voltage Range: 6...24V AC		10	700-AR1
	RC Surge Suppressor	• Voltage Range: 110...240V AC		10	700-AR2



Timing Modules

Photo	Description	Diagram	Cat. No.	
	Timing Module <ul style="list-style-type: none"> On-delay or One-Shot used with sockets that accept plug-in accessory modules Pkg. Qty: 1 	On-Delay  One-Shot 	12...24V AC/DC, selectable	
			110...125V AC, selectable	700-AT3
			230...240V AC, selectable	700-AT3A1
			700-AT3A2	

Adapters

	Description	For Use With	Pkg. Qty.	Cat. No.
	Flange Mount Adapter <ul style="list-style-type: none"> Used for panel-mounting Bulletin 700-HK relays Order must be for 10 adapters or multiples of 10 	700-HK relays	10	700-HN226
	35 mm Rail Mount Adapter <ul style="list-style-type: none"> Mounts Bulletin 700-HK relays to a 35 mm rail Order must be for 10 adapters or multiples of 10 	700-HK relays	10	700-HN227
	Socket Retainer Clip and Ejection Lever <ul style="list-style-type: none"> Orders must be for 10 clips or multiples of 10 	Cat. Nos. 700-HN22, -HN222, -HN223, and -HN224 sockets	10	700-HN229

Marking Systems

Photo	Description	Pkg. Qty.	Cat. No.
	Relay Identification Snap-in Markers <ul style="list-style-type: none"> Snap-in markers fit on top of product covers Squares slip into molded slot on top of product covers Use with Cat. No. 700-N40 or 700-N41 identification tags 	100	1492-MS6X9
			1492-MS6X12
			1492-MS8X9
			1492-MS8X12
	Pre-printed Identification Tags <ul style="list-style-type: none"> Contains 10 sheets of pre-printed and blank tags Each sheet contains 13 sets of the markings CR...9CR, TR...9TR, M...9M, F, R, 1S, and 117 blank tags Tags are peel-off with sticky backing for easy placement on relays 	10	700-N40
			Blank Identification Tags <ul style="list-style-type: none"> contains 10 sheets of blank identification tags for customer specialized printing Each sheet contains 546 blank tags Tags are peel-off with sticky backing for easy placement on relays.

Specifications

Table 31 - Electrical Ratings

Attribute			700-HK Relay			
			1-Pole, 1 CO, SPDT	2-Pole, 2 CO, DPDT		
Rated Thermal Current (I_{th})			16 A	8 A		
Rated Insulation Voltage (U_i)			IEC	250V		
			UL/CSA	300V		
Contacts	Inductive	AC	120V AC	AC-15, 6.2 A B300 Pilot Duty, 3 A A300 (700-HKM_) 1/3 Hp (0.24 kW) 1-phase	AC-15, 2.9 A B300 Pilot Duty, 3.0 A 1/4 Hp (0.18 kW), 1-phase	
			240V AC	AC-15, 3.1 A B300 Pilot Duty, 1.5 A A300 (700-HKM_) 3/4 Hp (0.55 kW), 1-phase	AC-15, 1.4 A B300 Pilot Duty, 1.5 A 1/2 Hp (0.37 kW), 1-phase	
			230V AC	0.55 kW, 1-phase	0.37 kW, 1-phase	
		DC	24V DC	DC-13, 5.0 A	DC-13, 3.0 A	
			125V DC	DC-13, 0.2 A / R300 Pilot Duty, 0.22 A	DC-13, 0.2 A / R300 Pilot Duty, 0.22 A	
			250V DC	DC-13, 0.1 A / R300 Pilot Duty, 0.11 A	DC-13, 0.1 A / R300 Pilot Duty, 0.11 A	
	Resistive	230V AC	AC-1, 16 A	AC-1, 8 A		
		277V AC	16 A, General Use	8 A, General Use		
	Make, Break, and Continuous			30V DC	DC-1, 12 A / 10 A, Resistive	DC-1, 6 A / 6 A, Resistive
	Minimum Low Energy Permissible Load			AgNi Contacts (700-HK3_)		300 mW (5V/60 mA or 60V/5 mA)
AgNi + Gold Contacts (700-HKX_)				50 mW (5V/10 mA or 25V/2 mA)		
AgSnO ₂ Contacts (700-HKM_)				500 mW (100V/5 mA or 5V/100 mA)		
Permissible Coil Voltage Variation			Pickup	50/60 Hz	80...110% of nominal voltage	
				DC	73...110% of nominal voltage	
			Holding	50/60 Hz	80% of nominal voltage	
				DC	40% of nominal voltage	
			Must Drop Out	50/60 Hz	20% of nominal voltage	
				DC	10% of nominal voltage	
Power Consumption			AC	1.2 VA		
			DC	0.5 W		

Table 32 - Mechanical Ratings

Attribute		700-HK Relay	
		1-Pole, 1 CO, SPDT	2-Pole, 2 CO, DPDT
Degree of Protection (Open Type) IEC 529		IP 20 (guarded terminal sockets), RT II – Flux-proof (Relay)	
Mechanical Life Operations (AC/DC)		10 x 10 ⁶	
Electrical Life Operations	230V AC	16 A Resistive: 100 000 min	8 A Resistive: 100 000 min
	277V AC	16 A Resistive: 30 000 min	8 A Resistive: 30 000 min
	30V DC	10 A Resistive: 30 000 min	6 A Resistive: 30 000 min
	B300, R300	Hp (kW): 6000 min	Hp (kW): 6000 min
	A300 (700-HKM_)	100,000 min	—
Switching Frequency Operations	Mechanical	18,000/h	
	Electrical	900/h	
Coil Voltages		See page 46	
Operating Time at Nominal Voltage at 20 °C (68 °F)	Pickup	15 ms	
	Dropout	5 ms	
Vibration	Operational	10...2000 Hz, 0.76 mm (0.03 in.) 2.5 G	
	Non-operational	10...2000 Hz, 0.76 mm (0.03 in.) 5.0 G	
Shock	Operational	15G	
	Non-operational	50 G	

Table 33 - Environmental Ratings

Attribute		700-HK Relay	
Temperature	Operating	[°C]	-40...+70
		[°F]	-40...+158
	Storage	[°C]	-40...+100
		[°F]	-40...+212
Altitude		2000 m (6560 ft)	

Table 34 - Construction

Attribute		700-HK Relay	
		1-Pole, 1 CO, SPDT	2-Pole, 2 CO, DPDT
Insulating Material		Molded High-Dielectric Material	
Enclosure		Transparent Dust Cover	
Contact Material	700-HK3_:	Silver nickel (AgNi)	
	700-HKX_:	Silver Nickel + Gold Plating (AgNi + Au)	
	700-HKM_:	Silver Tin Oxide (AgSnO ₂)	
Terminal Markings on Socket		In accordance with EN50 0005	
Sockets	Screw Terminal	700-HN121: 10 A @ 70 °C (158 °F) 700-HN221: 16 A @ 50 °C (122 °F), 12 A @ 70 °C (158 °F)	700-HN122: 2 x 6 A @ 70 °C (158 °F) 700-HN222: 2 x 8 A @ 70 °C (158 °F)
	Spring Clamp	700-HN223: 15 A @ 40 °C (104 °F) with 2 conductors per terminal) 10 A @ 70 °C (158 °F) with 1 conductor per terminal)	700-HN224: 2 x 8 A @ 70 °C (158 °F)

Table 35 - Standards Compliance and Certifications

Attribute	700-HK Relay
Certifications	<ul style="list-style-type: none"> • CSA Certified (File 75088) • UL Recognized (File E3125, Guide NLDX2/NLCX8) • cULus Listed with Allen-Bradley® sockets (File No. 3125 Guide NLDX/NLDX7) • CE Marked
Standards Compliance	<ul style="list-style-type: none"> • UL508 • CSA C22.2 No. 14, • EN 61810-1

Approximate Dimensions

Approximate dimensions are shown in millimeters (inches). Dimensions are not intended for manufacturing purposes.

Figure 34 - Cat. No. 700-HK36_ (SPDT)

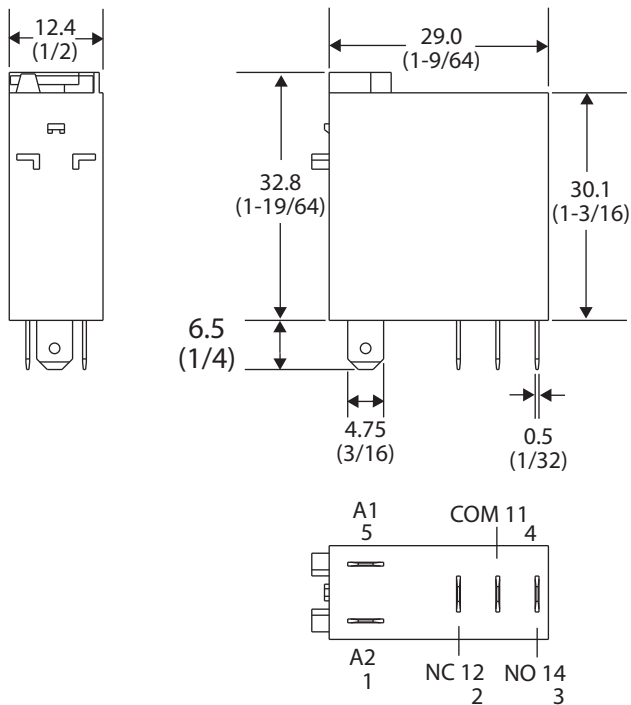
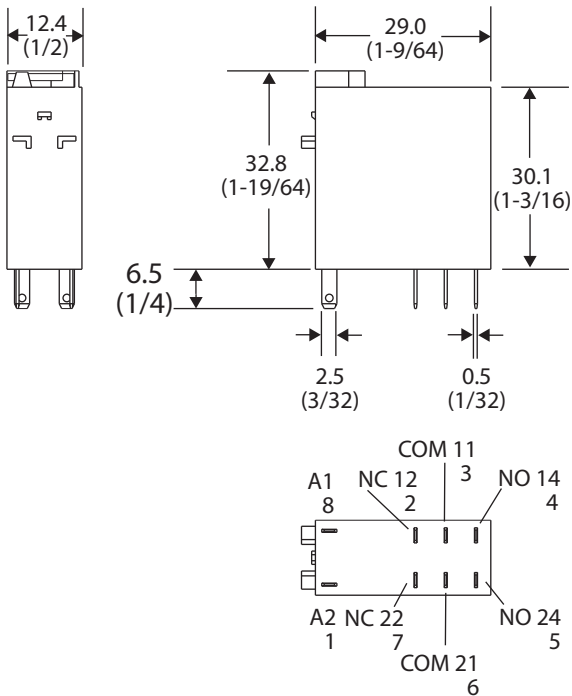
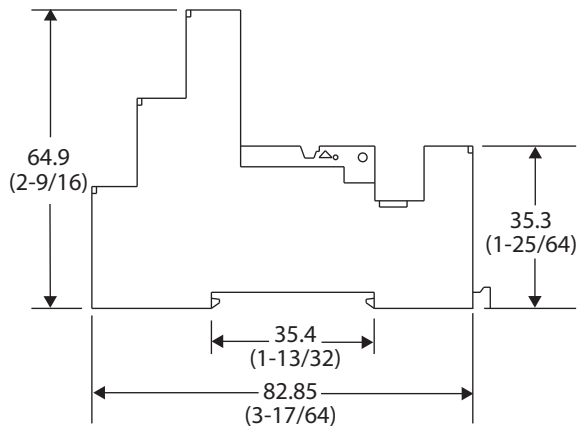
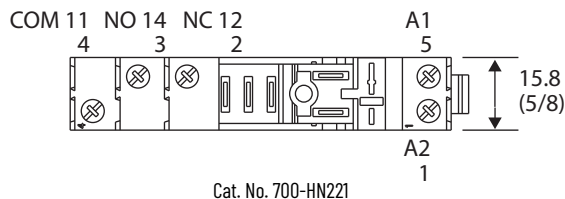
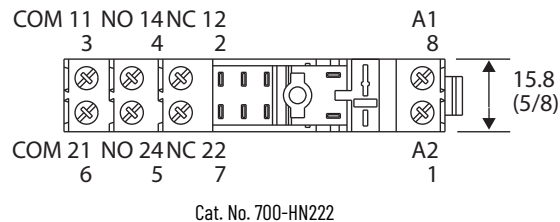


Figure 35 - Cat. No. 700-HK32_ (DPDT)



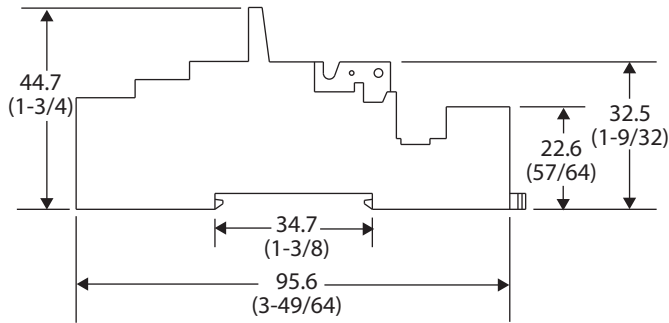
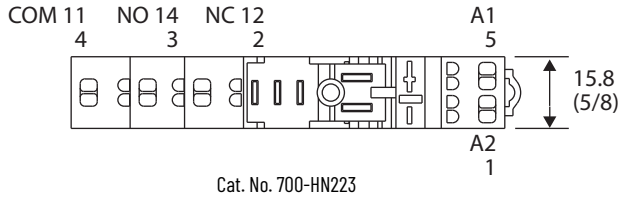
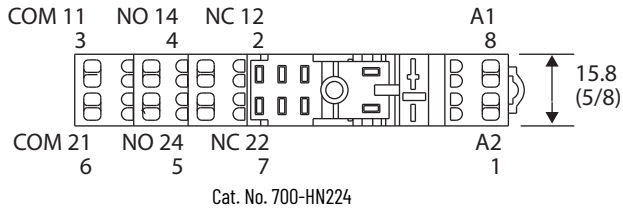
Sockets

Figure 36 - Cat. No. 700-HN221, -HN222



Wire Size: 0.2...2.5 mm² (#24...12 AWG)
 Either Solid or Stranded
 Strip Length: 8 mm (5/16 in.) - Torque: 0.8 N•m (7 lb•in)

Figure 37 - Cat. No. 700-HN223, -HN224



Wire Size: 0.2...1.5 mm² (#24...12 AWG)
 Either Solid or Stranded
 Strip Length: 8 mm (5/16 in.) - Torque: 0.8 N·m (7 lb·in)

Figure 38 - Cat. No. 700-HN226

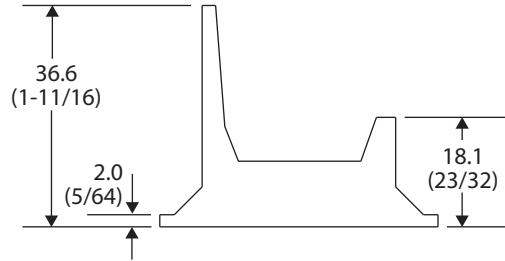
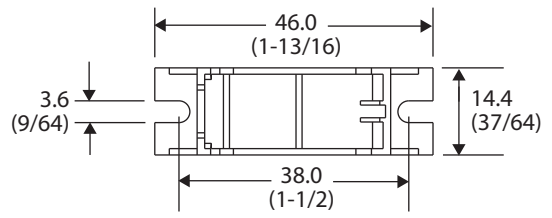


Figure 39 - Cat. No. 700-HN227

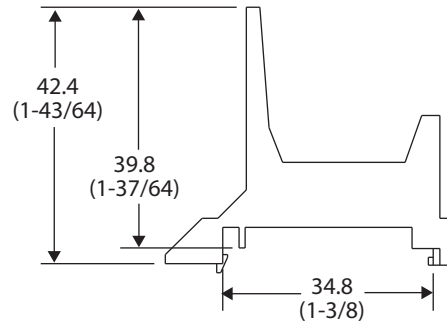
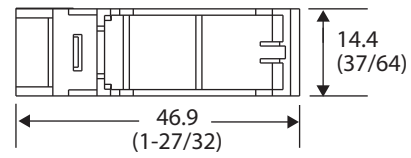


Figure 40 - Cat. No. 199-DR1 DIN Mounting Rail, Series B

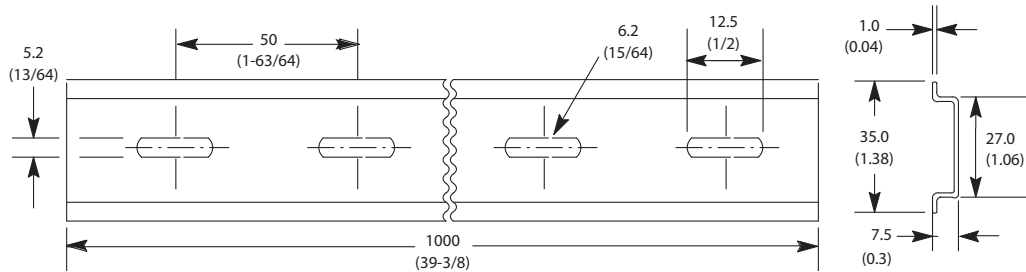
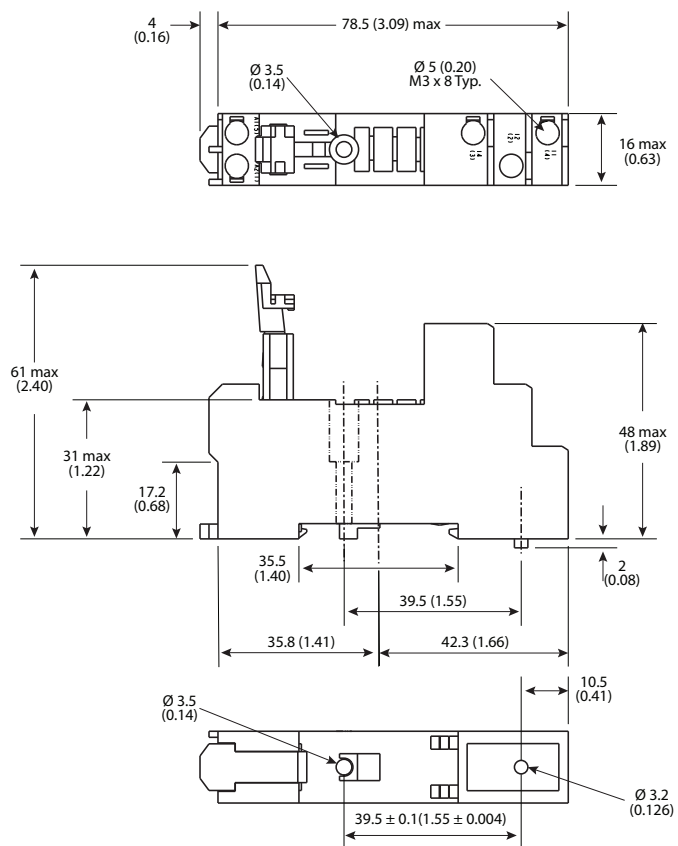
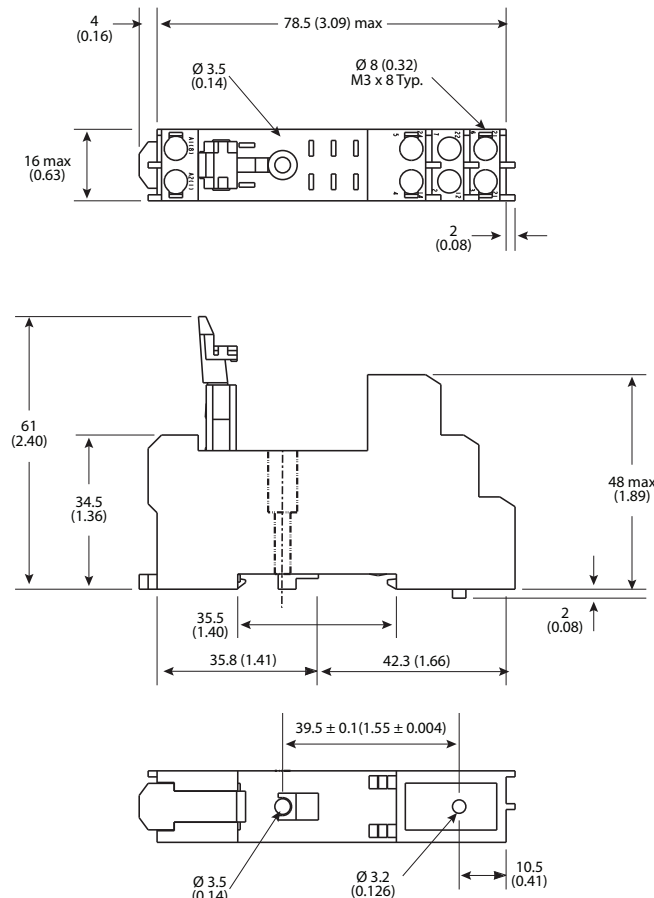


Figure 41 - Cat. No. 700-HN121



Wire Size: 2 x 2.5 mm²
 Single Wire - Up to #14 AWG
 Double Wire - 2 x 2.5 mm² (14 AWG... 20 AWG) Qty. 2 wires
 (Either Solid or Stranded)
 Strip Length: 9 mm (3/8 in.) - Torque: 0.8 N·m (7 lb·in)

Figure 42 - Cat. No. 700-HN122



Wire Size: 2 x 2.5 mm²
 Single Wire - Up to #14 AWG
 Double Wire - 2 x 2.5 mm² (14 AWG... 20 AWG) Qty. 2 wires
 (Either Solid or Stranded)
 Strip Length: 9 mm (3/8 in.) - Torque: 0.8 N·m (7 lb·in)

700-HL Terminal Block Relay



- Relay and socket assembled interface modules for high density interposing or isolation applications
- Screw terminal and spring-clamp bases
- 6 A relay, choice of silver or gold contacts
- 2 A solid-state relay – DC output
- 2 A solid-state relay – AC output
- SPDT (relay), 1 N.O. (solid-state)
- Built-in retainer clip and snap-in marker lever
- Standard LED, reverse polarity protection, and surge protection
- Externally replaceable relay modules
- Unique leakage current suppression version to address industry concerns of nuisance coil turn-on or contact non-drop out when connecting to PLCs with leakage current
- Available with hazardous location certification

Product Selection

Terminal Block Relays

Standard built-in Features:				
	Cat. No. 700-HLT1Z24	Cat. No. 700-HLT2Z24	Cat. No. 700-HLS1Z24	Cat. No. 700-HLS1I24
Standard built-in Features:	<ul style="list-style-type: none"> • LED • Reverse Polarity Protection for DC Inputs • Coil Surge Protection⁽¹⁾ 			
Specifications			⁽²⁾ 	
Output Type	SPDT (1 C/O); $I_{th} = 6A^{(3)}$		1 N.O. solid-state; $I_{th} = 2 A, 24V DC$ or $I_{th} = 2 A, 240V AC$	
Recommended Tightening Torque	0.5 N•m max (4.4 lb•in)			
Wire Range	Screw Terminal	0.14 mm ² ...2.5 mm ² (#26...#14 AWG)		
	Spring Terminal	0.2 mm ² ...2.5 mm ² (#24...#14 AWG)		
Certifications	UL, cULus, cURus, ABS, CE			

(1) Diode surge protection provided.

(2) Reverse polarity on the output terminals of the solid-state relay will result in the output being "ON" regardless of the state of the input voltage.

(3) For Gold-plated contacts: Add the letter "X" at the end of the catalog number. For example: if Cat. No. 700-HLT1Z24 is required with gold plating, the new cat. no. is 700-HLT1Z24X.

Terminal Block Relay Selection

Input Voltage	Pkg. Qty.	Cat. No.		Pkg. Qty.	Cat. No.		
		Screw Terminals	Spring Clamp Terminals		Screw Terminals (DC Output)	Spring Clamp Terminals (DC Output)	Screw Terminals (AC Output)
12V DC	10	700-HLT1Z12 ⁽¹⁾	700-HLT2Z12	—	—	—	—
24V DC	10	700-HLT1Z24 ⁽¹⁾	700-HLT2Z24	10	700-HLS1Z24 ⁽¹⁾	700-HLS2Z24	700-HLS1I24
48V DC	10	700-HLT1Z48 ⁽¹⁾	700-HLT2Z48	10	700-HLS1Z48 ⁽¹⁾	700-HLS2Z48	700-HLS1I248
12V AC/DC	10	700-HLT1U12	700-HLT2U12	—	—	—	—
24V AC/DC	10	700-HLT1U24	700-HLT2U24	—	—	—	—
48V AC/DC	10	700-HLT1U48	700-HLT2U48	—	—	—	—
110/125V AC/DC	10	700-HLT1U1	700-HLT2U1	10	700-HLS1U1 ⁽¹⁾	700-HLS2U1	700-HLS1IU1
220...240V AC/DC	10	700-HLT1U2	700-HLT2U2	10	700-HLS1U2 ⁽¹⁾	700-HLS2U2	700-HLS1IU2
240V AC	10	700-HLT1A2	—	—	—	—	—






Terminal Block Relay Selection (Continued)

Input Voltage	Pkg. Qty.	Cat. No.		Pkg. Qty.	Cat. No.		
		Screw Terminals	Spring Clamp Terminals		Screw Terminals (DC Output)	Spring Clamp Terminals (DC Output)	Screw Terminals (AC Output)
Built-in LCSC (leakage current suppression circuit) 120V AC and 125V DC ⁽²⁾	10	700-HLT1L1 ⁽¹⁾	—	10	700-HLS1L1 ⁽¹⁾	—	700-HLS1L1
Built-in LCSC (leakage current suppression circuit) 240V AC ⁽²⁾	10	700-HLT1L2 ⁽¹⁾	—	10	700-HLS1L2 ⁽¹⁾	—	700-HLS1L2
Hazardous Location Certification 24V DC	10	700-HLT1Z24-EX	—	10	—	—	—
Hazardous Location Certification 12V DC	10	700-HLT1Z12-EX	—	10	—	—	—
Hazardous Location Certification 110/125V AC/DC	10	700-HLT1U1-EX	—	10	—	—	—

(1) Electromechanical relay to solid-state relay interchangeability is possible.
 (2) Leakage current suppression up to 2.2 mA off state current.

Accessories

Terminal Block Relay Accessories

Photo	Description	Pkg. Quantity	Socket Input Voltage	Cat. No.
	Replacement Relays ⁽¹⁾ • Order must be for 20 relays or multiples of 20	20	12V AC/DC	700-TBR12
			24V AC/DC	700-TBR24
			48V AC/DC	700-TBR48
			110/125V AC/DC 220...240V AC/DC	700-TBR60
	Replacement SSR • 4-blade miniature relay for use with 1 N.O. SSR DC output • Order multiples of 20	20	24V DC	700-TBS24
			48V DC, 110/125V AC/DC 220...240V AC/DC	700-TBS60
	Replacement SSR • 4-blade miniature relay for use with 1 N.O. SSR AC output • Order multiples of 20	20	24V DC	700-TBS124
	20-Way Jumper • Can be cut to required length • $I_{th} = 36$ A max per 20-way jumper	1	Red	700-TBJ20R
			Grey	700-TBJ20G
			Blue	700-TBJ20B
	End Barrier • Used for visual inspection of groups, safe separation of neighboring 700-HL modules that end with jumpers	10	Black	700-HN177
	Snap-in Marker • These snap-in markers have a 6 x 10 mm surface and snap into the ejection lever for the relay • For custom markers, contact your local Rockwell Automation sales office or Allen-Bradley distributor for more information	100	Blank	1492-MC6X10

(1) For gold-plated contacts: Add the letter "X" at the end of the catalog number. For example: if Cat. No. 700-TBR24 is required with gold plating, the new cat. no. is 700-TBR24X.

Specifications

Cat. No. 700-HLT... (Relay Output)

Table 36 - Electrical Ratings

Attribute			Cat. No. 700-HLT... (Relay Output)			
Pilot Duty Rating			B 300, R 300			
Rated Thermal Current (I_{th})			1-Pole – 6 A			
Rated Insulation Voltage (U_i)			IEC	250V		
			UL/CSA	300V		
Contacts	Inductive	1-Pole	Contact Type	Make	Break	
			24V AC, 1-phase	▶ ◀	◀ ▶	
			120V AC, 1-phase	30 A	5 A	
			240V AC, 1-phase	30 A	3 A	
			24V DC	15 A	1.5 A	
			125V DC	DC-13, 1.0 A	–	
			240V DC	DC-13, 0.2 A		
	Resistive Make, Break, and Continuous	24V DC	DC-13, 0.1 A	6.0 A		
		250V AC	6.0 A			
		240V DC	0.1 A			
Inductive Load			AC-15	250V, 3 A N.O. Contact, 1.5 A N.C. Contact		
			DC-13	24V, 1 A N.O., and N.C. Contact		
Min Permissible Contact Ratings			Silver Contacts	12V, 6 mA (72 mW)		
			Gold Contacts	8V, 2.5 mA (20 mW)		
Permissible Coil Voltage Variation			Pickup	50 Hz	85...110% of Nominal Voltage	
				60 Hz	85...110% of Nominal Voltage	
				DC	80...110% of Nominal Voltage	
			Must Dropout	AC	10% of Nominal Voltage	
				DC	5% of Nominal Voltage	
Power Consumption ±10%			AC	0.3VA		
			DC	0.2 W		
Design Specification/Test Requirements			Dielectric Withstand Voltage			
			Pole to Pole (VRMS)		1000V	
			Contact to Coil (VRMS)		4000V	
			Impedance at input voltage:		12V AC/DC	1 kΩ
					24V AC/DC	2 kΩ
					48V AC/DC	6 kΩ
					120V AC/DC	26 kΩ
					240V AC/DC	56 kΩ
120V LCSC	16 kΩ					
240V LCSC	35 kΩ					

Table 37 - Mechanical Ratings

Attribute			Cat. No. 700-HLT... (Relay Output)
Degree of Protection (Open Type) IEC 529			IP 20
Mechanical Life Operations			1 x 10 ⁷
Electrical Life Operations	Resistive	6 A	100,000 min
	Inductive	24V DC, 1 A	200,000 min
		120V AC 1 A	300,000 min
Switching Frequency Operations			3600/h
Coil Voltages			See page 54
Operating Time	at Nominal Voltage at 20 °C (68 °F)	Pickup	7 ms
		Dropout	3 ms
Maximum Operating Rate		full load = 6 A	6 cycles/min
Coil Surge Protection			Per EN 61000-4.5; Surge Immunity (801-5) Class III: 2 kV common and 1 kV differential mode

Table 38 - Environmental Ratings

Attribute			Cat. No. 700-HLT... (Relay Output)
Temperature	Operating	[°C]	-40...+55
		[°F]	-40...+131
	Storage	[°C]	-40...+100
		[°F]	-40...+212
Altitude			2000 m (6560 ft)

Table 39 - Construction

Attribute	Cat. No. 700-HLT... (Relay Output)
Insulating Material	Molded High-Dielectric Material
Enclosure	Relay IP67
Contact Material	Silver Tin Ox, AgSnO ₂ or Silver with Gold Plating, AgSnO ₂ + Au
Terminal Markings on Socket	In accordance with EN50 0005

Table 40 - Standards Compliance and Certifications

Attribute	Cat. No. 700-HLT... (Relay Output)	
Certifications	<ul style="list-style-type: none"> cULus Listed (File No. E3125, E14843 Guide NLDX/NLDX7) with Allen-Bradley® socket CE Marked ABS (American Bureau of Shipping) 	
Standards	<ul style="list-style-type: none"> EN 61810-1 CSA 22.2 UL 508 NEMA IEE MAC Compliant ICS-2 Compliant 	
Hazardous Location Approvals	—	Class 1, Zn 2, Groups IIC, Ex nC IIC T5 Ta < 55 °C
	UL Listed (UL 60079-15)	<ul style="list-style-type: none"> 700-HLT1Z12-EX (12V DC supply) 700-HLT1Z24-EX, 700-HLS1Z24-EX (24V DC supply) 700-HLT1U1-EX, 700-HLS1U1-EX (110V/125V AC/DC supply)
	CSA Certified ⁽¹⁾ (CAN/CSA E60079-15)	<ul style="list-style-type: none"> 700-HLT1Z12-EX (12V DC supply) 700-HLT1Z24-EX, 700-HLS1Z24-EX (24V DC supply)

(1) Product shall be installed in an enclosure providing at least IP54 protection. Provisions shall be made to prevent the rated voltage from being exceeded by transient disturbances of more than 40%.

Cat. No. 700-HLS... (Solid-state Output)

Table 41 - Electrical Ratings

Attribute			Cat. No. 700-HLS... (Solid-state Output)		
Rated Thermal Current (I_{th})	AC output		2 A		
	DC output		2 A		
Rated Insulation Voltage (U_i)	IEC		250V		
	UL/CSA		300V		
Control Circuits	Min Control Voltage		80% nominal voltage		
	Max Control Voltage		110% nominal voltage		
	Control Current	24V		9 mA ±105	
		120/240V		0.35 x nominal voltage	
	Release Voltage	24V		0.4 x nominal voltage	
		120/240V		0.35 x nominal voltage	
	Min Control Circuit Resistance	AC output	24V	3200 Ω	
			120V	16 kΩ	
			240V	32 kΩ	
		DC output	24V	2500 Ω	
120V			12 kΩ		
240V			24 kΩ		
Power Consumption ±10%	AC	120V	0.6VA		
		240V	1 VA		
	DC	AC output	0.2 W		
		DC output	0.3 W		
Design Specification/Test Requirements	Dielectric Withstand Voltage		Pole to Pole (VRMS)	2500V	
			Contact to Coil (VRMS)	2500V	
	Impedance at input voltage:		24V DC	2 kΩ	
			48V DC	9 kΩ	
			120V AC/DC	26 kΩ	
			240V AC/DC	58 kΩ	
			120V LCSC	16 kΩ	
240V LCSC	35 kΩ				

Table 42 - Mechanical Ratings

Attribute				Cat. No. 700-HLS... (Solid-state Output)	
Degree of Protection (Open Type) IEC 529				IP 20	
Input Voltages				See page 54	
Operating Time	at Nominal Voltage at 20 °C (68 °F)	Turn on	DC only	30 μs	
			AC/DC	7 ms	
		Dropout	DC only	350 μs	
			AC/DC	6 ms	
Maximum Operating Rate				300 Hz	

Table 43 - Environmental Ratings

Attribute			Cat. No. 700-HLS... (Solid-state Output)	
Temperature	Operating	[°C]	-20...+55	
		[°F]	-4...+131	
	Storage	[°C]	-40...+70	
		[°F]	-40...+158	
Altitude			2000 m (6560 ft)	

Table 44 - Construction

Attribute	Cat. No. 700-HLS... (Solid-state Output)
Insulating Material	Molded High-Dielectric Material
Enclosure	Relay IP67
Terminal Markings on Socket	In accordance with EN50 0005

Table 45 - Standards Compliance and Certifications

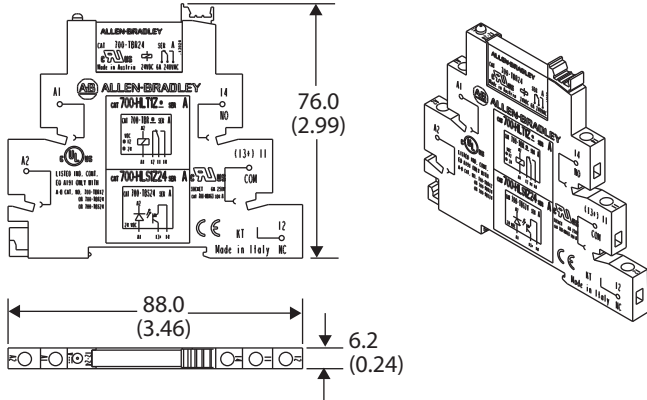
Attribute	Cat. No. 700-HLS... (Solid-state Output)	
Certifications	<ul style="list-style-type: none"> cULus Listed (File No. E14843, Guide NLDX/NLDX7), CE Marked ABS (American Bureau of Shipping) 	
Standards	<ul style="list-style-type: none"> CSA 22.2, No. 14 UL 508 EN 61810-1 	
	Class 1, Zn 2, Groups IIC, Ex nC IIC T5 Ta < 55 °C	
Hazardous Location Approvals	— UL Listed (UL 60079-15)	<ul style="list-style-type: none"> 700-HLT1Z12-EX (12V DC supply) 700-HLT1Z24-EX, 700-HLS1Z24-EX (24V DC supply) 700-HLT1U1-EX, 700-HLS1U1-EX (110V/125V AC/DC supply)
	CSA Certified ⁽¹⁾ (CAN/CSA E60079-15)	<ul style="list-style-type: none"> 700-HLT1Z12-EX (12V DC supply) 700-HLT1Z24-EX, 700-HLS1Z24-EX (24V DC supply)

(1) Product shall be installed in an enclosure providing at least IP54 protection. Provisions shall be made to prevent the rated voltage from being exceeded by transient disturbances of more than 40%.

Approximate Dimensions

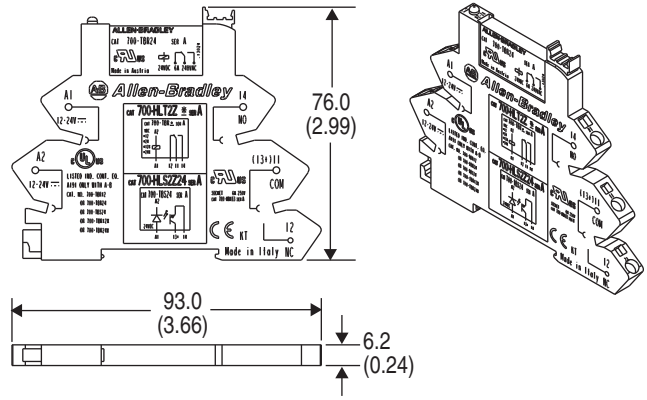
Approximate dimensions are shown in millimeters (inches). Dimensions are not intended for manufacturing purposes.

Figure 43 - 700-HLT/-HLS Screw Terminal Design



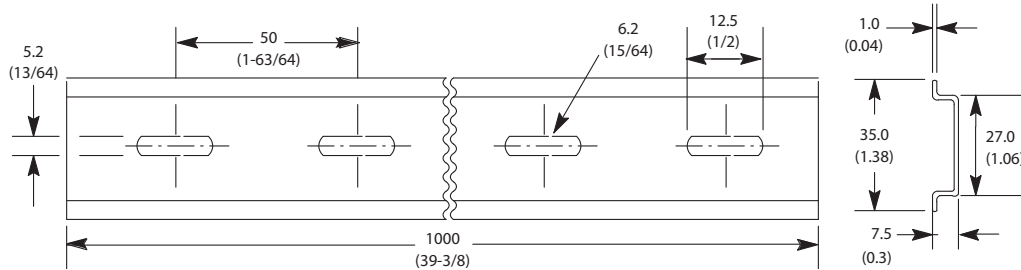
Single Wire: 0.14 mm²...2.5 mm² (#26 AWG...#14 AWG)
 Double wire: 2 x 0.14 mm²...2.5 mm² (#26 AWG...#14 AWG)
 Wire Type: Solid or stranded, copper only
 Strip Length: 9 mm (11/32 in.)
 Tightening torque: 0.5 N·m (4.4 lb·in)

Figure 44 - 700-HLT/-HLS Spring Terminal Design



Single Wire: 0.2 mm²...2.5 mm² (#24 AWG...#14 AWG)
 Wire Type: Solid or stranded, copper only
 Strip Length: 9 mm (11/32 in.)

Figure 45 - Cat. No. 199-DR1 DIN Mounting Rail, Series B



700-HL_N Next Generation Terminal Block Relay

- Relay and socket assembled interface modules for high density interposing or isolation applications
- Screw terminal and push-in terminal bases
- 6 A relay, choice of silver or gold contacts
- 2 A solid-state relay – DC output
- 2 A solid-state relay – AC output
- SPDT (relay), 1 N.O. (solid-state)
- Built-in retainer clip and snap-in marker lever
- Standard LED, reverse polarity protection, and surge protection
- Externally replaceable relay modules
- Universal input voltage versions
- Available with hazardous location certification



Standard built-in Features: • LED • Reverse Polarity Protection for DC Inputs • Coil Surge Protection ⁽¹⁾				
	Cat. No. 700-HLTN1	Cat. No. 700-HLTN2	Cat. No. 700-HLSN1	Cat. No. 700-HLSN2
Specifications				
Output Type	SPDT (1 C/O); $I_{th} = 6A^{(3)}$		1 N.O. solid-state; $I_{th} = 2 A, 24V DC$ or $I_{th} = 2 A, 240V AC$	
Recommended Tightening Torque	0.5 N•m max (4.4 lb•in)			
Wire Range	Screw Terminal: 0.14 mm ² ...2.5 mm ² (#26...#14 AWG), Push-in Terminal: 0.2 mm ² ...2.5 mm ² (#24...#14 AWG)			
Approvals	UL, cULus, cURus, ABS, CE			

(1) Diode surge protection provided.

(2) Reverse polarity on the output terminals of the solid-state relay will result in the output being "ON" regardless of the state of the input voltage.

(3) For Gold-plated contacts: Add the letter "X" at the end of the catalog number. For example: if Cat. No. 700-HLTNU24 is required with gold plating, the new cat. no. is 700-HLTNU24X.

Product Selection

Input Voltage	Pkg. Qty.	Cat. No.					
		Screw Terminals	Push-in Terminals	DC Output		AC Output	
				Screw Terminals	Push-in Terminals	Screw Terminals	Push-in Terminals
12V AC/DC	10	700-HLTN1U12	700-HLTN2U12	—	—	—	—
24V AC/DC	10	700-HLTN1U24	700-HLTN2U24	700-HLSN1U24	700-HLSN2U24	700-HLSN1U24	700-HLSN2U24
24...240V AC/DC ⁽¹⁾	10	700-HLTN1U18	700-HLTN2U18	700-HLSN1U18	700-HLSN2U18	700-HLSN1U18	700-HLSN2U18
Hazardous Location Certification 12V AC/DC	10	700-HLTN1U12-EX	700-HLTN2U12-EX	—	—	—	—
Hazardous Location Certification 24V AC/DC	10	700-HLTN1U24-EX	700-HLTN2U24-EX	700-HLSN1U24-EX	700-HLSN2U24-EX	700-HLSN1U24-EX	700-HLSN2U24-EX
Hazardous Location Certification 24...240V AC/DC	10	700-HLTN1U18-EX	700-HLTN2U18-EX	700-HLSN1U18-EX	700-HLSN2U18-EX	700-HLSN1U18-EX	700-HLSN2U18-EX

(1) Leakage current suppression up to 2.2 mA off state current.

Accessories

Photo	Description	Pkg. Quantity	Socket Input Voltage	Cat. No.
	Replacement Relays ⁽¹⁾ <ul style="list-style-type: none"> Order must be for 20 relays or multiples of 20. 	20	12V AC/DC	700-TBR12
			24V AC/DC 24...240V AC/DC	700-TBR24
	Replacement SSR <ul style="list-style-type: none"> 4-blade miniature relay for use with 1 N.O. SSR DC output Order multiples of 20. 	20	24V AC/DC	700-TBS24
			24V AC/DC 24...240V AC/DC	700-TBS124
	16-Way Jumper <ul style="list-style-type: none"> Can be cut to required length. $I_{th} = 36$ A max per 16-way jumper. Maximum 6 A per pole. 	1	Red	700-TBJ16R
			Grey	700-TBJ16G
			Blue	700-TBJ16B
	Terminal Doubler <ul style="list-style-type: none"> Allows two wires per one push-in terminal. Max wire 2 X 1.5 mm² (2 X #16 AWG) 	5	—	700-TBT2
	Terminal Block Relay Wiring Adapter <ul style="list-style-type: none"> Plugs into 700-HL_N Relays Photo shown with Cat. No. 700-TBCBL cable plugged in 	1	—	700-TBWA
	Cable <ul style="list-style-type: none"> Used with 700-TBWA 1.98 m (6.5 ft) cable 	1	—	700-TBCBL
	End Barrier <ul style="list-style-type: none"> Used for visual inspection of groups, safe separation of neighboring 700-HLN modules that end with jumpers. 	10	Black	700-HN377
	Snap-in Marker <ul style="list-style-type: none"> These snap-in markers have a 6 x 10 mm surface and snap into the ejection lever for the relay For custom markers, contact your local Rockwell Automation sales office or Allen-Bradley distributor for more information 	100	Blank	1492-MC6X10

(1) For gold-plated contacts: Add the letter "X" at the end of the catalog number. For example: if Cat. No. 700-TBR24 is required with gold plating, the new cat. no. is 700-TBR24X.

Specifications

700-HLTN Relay Outputs

Table 46 - Electrical Ratings

Attribute			700-HLTN (Relay Output)		
Pilot Duty Rating ⁽¹⁾			NEMA B300, R300		
Rated Thermal Current (I_{th})			1-Pole – 6 A		
Rated Insulation Voltage (U_i)		IEC	250V		
		UL/CSA	300V		
Contacts	Inductive	Contact Type		Make	Break
				▶ ◀	◀ ▶
		AC	24V AC, 1-phase	30 A	
			120V AC, 1-phase	30 A	
			240V AC, 1-phase	15 A	
		DC	24V DC	DC-13, 1.0 A	
	125V DC		DC-13, 0.2 A		
	240V DC		DC-13, 0.1 A		
	Resistive • Make, Break, and Continuous	24V DC	6.0 A		
		250V AC	6.0 A		
240V DC		0.1 A			
Inductive Load			AC-15 250V, 3 A N.O. Contact, 1.5 A N.C. Contact DC-13 24V, 1 A N.O., and N.C. Contact		
Min Permissible Contact Ratings		Silver Contacts	12V, 10 mA (120 mW)		
		Gold Contacts	8V, 3 mA (25 mW)		
Permissible Coil Voltage Variation		Pickup	80...110% of Nominal Voltage at DC		
		Must Drop out	10% of Nominal Voltage		
Power Consumption ±10%		AC	0.4 VA		
		DC	0.3 W		
Design Specification/Test Requirements	Electrical	Dielectric Withstand Voltage	Pole to Pole (VRMS)	1000V	
			Contact to Coil (VRMS)	4000V	
	Electrical Life (Operating)		6 A Resistive	100,000 min	
			24V DC, 1 A Inductive	200 000 min	
		120V AC 1 A Inductive	300 000 min		

(1) See [NEMA Ratings and Test Values on page 5](#)

Table 47 - Mechanical Ratings

Attribute		700-HLTN Relay
Degree of Protection (Open Type) IEC 529		IP 20
Mechanical Lifecycles (AC/DC)		1×10^7
Switching Frequency Operations (no-load)		10 cycles/s
Coil Voltages		See page 61
Operating Time	Pickup	6 ms
	Dropout	200 ms
Maximum Operating Rate (full load = 6 A)		6 cycles/min
Coil Surge Protection		Per EN 61000-4-5; Surge Immunity (801-5) Class III: 2 kV common and 1 kV differential mode

Table 48 - Environmental Ratings

Attribute		700-HLTN Relay
Temperature	Operating	[°C]
		[°F]
	Storage	[°C]
		[°F]
Altitude		2000 m (6560 ft)

Table 49 - Construction

Attribute	700-HLTN Relay
Insulating Material	Molded High-dielectric Material
Enclosure	Relay IP67
Contact Material	Silver Tin Oxide, AgSnO ₂ or Silver with Gold Plating, AgSnO ₂ + Au
Terminal Markings on Socket	In accordance with EN50 0005

Table 50 - Standards Compliance and Certifications

Attribute	700-HLTN Relay
Certifications	<ul style="list-style-type: none"> cULus Listed (File No. E3125, E14843 Guide NLDX/NLDX7) with Allen-Bradley socket CE Marked
Standards Compliance	<ul style="list-style-type: none"> UL508 CSA C22.2 EN 61810-1 NEMA IEE MAC Compliant ICS-2 Compliant
Hazardous Location Approvals	Class 1, Zn 2, Groups IIC, Ex nC IIC T6 Ta < 70 °C
	UL Listed (UL 60079-15)
	CSA Certified ⁽¹⁾ (CAN/CSA E60079-15)

(1) Product shall be installed in an enclosure providing at least IP54 protection. Provisions shall be made to prevent the rated voltage from being exceeded by transient disturbances of more than 40%.

700-HLSN Solid-state Outputs

Table 51 - Electrical Ratings

Attribute			700-HLSN (Solid-state Output)	
Rated Thermal Current (I_{th})	AC Output		2 A	
	DC Output		2 A	
Rated Insulation Voltage (U_i)	IEC		250V	
	UL/CSA		300V	
Control Circuit	Control Voltage	Min	80% nominal voltage	
		Max	110% nominal voltage	
	Control Current	24V	9 mA \pm 10%	
		120/240V	4 mA \pm 10%	
Release Voltage	24V	0.4 x nominal voltage		
	120/240V	0.35 x nominal voltage		
Outputs	Load Voltage Range	AC	12...275V	
		DC	1.5...33V	
	Max Repetitive Blocking Voltage	AC	600V	
		DC	33V	
	Max Switching Current (inductive/resistive)	AC	2 A	
		DC	2 A	
	On State Voltage Drop @ Max Switching Current	AC	<1.5V	
		DC	<400 mV	
Leakage Current	AC	max 1.5 μ A		
	DC	max 100 μ A		
Power Consumption \pm 10%	AC	120V	0.6 VA	
		240V	1 VA	
	DC	24V	0.3 W	
Design Specification/Test Requirements	Electrical	Dielectric Withstand Voltage	Pole to Pole (VRMS)	2500V
			Contact to Coil (VRMS)	3000V

Table 52 - Mechanical Ratings

Attribute			700-HLSN (Solid-state Output)
Degree of Protection (Open Type) IEC 529			IP 20
Input Voltages			See page 54
Operating Time at Nominal Voltage at 20 °C	Turn on Time	AC/DC input voltage	12 ms
		DC only input voltage	200 μ s
	Drop Out Time	AC/DC input voltage	120 ms
		DC only input voltage	600 μ s
Maximum Operating Frequency			300 Hz

Table 53 - Environmental Ratings

Attribute			700-HLSN (Solid-state Output)
Temperature	Operating	[°C]	-20...+70
		[°F]	-4...+158
	Storage	[°C]	-40...+70
		[°F]	-40...+158
Altitude			2000 m (6560 ft)

Table 54 - Construction

Attribute	700-HLSN (Solid-state Output)
Insulating Material	Molded High-dielectric Material
Enclosure	Relay IP67
Terminal Markings on Socket	In accordance with EN50 0005

Table 55 - Standards Compliance and Certifications

Attribute	700-HLSN (Solid-state Output)
Certifications	<ul style="list-style-type: none"> cULus Listed (File No. E14843, Guide NLDX/NLDX7) CE Marked ABS (American Bureau of Shipping)
Standards Compliance	<ul style="list-style-type: none"> UL508 CSA C22.2 EN 61810-1
Hazardous Location Approvals	Class 1, Zn 2, Groups IIC, Ex nC IIC T6 Ta < 70 °C
	UL Listed (UL 60079-15)
	CSA Certified ⁽¹⁾ (CAN/CSA E60079-15)

(1) Product shall be installed in an enclosure providing at least IP54 protection. Provisions shall be made to prevent the rated voltage from being exceeded by transient disturbances of more than 40%.

Cable Connection and Wire Colors

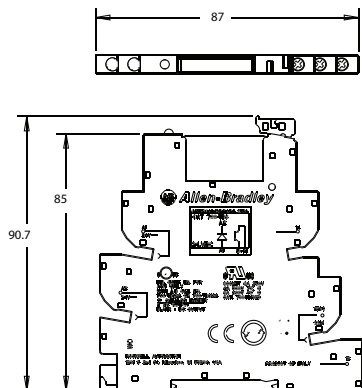
Table 56 - Cat. No. 700-TBCBL to 700-TBWA Connections, for all 700-HL_N Relays

Relay Coil Connection	Cat. No. 700-TBWA	700-TBCBL			
	Terminal	Connector	Wire 1 Color	Wire 2 Color	Wire 3 Color
A1	0	1	White	—	—
	1	2	Brown	—	—
	2	3	Green	—	—
	3	4	Yellow	—	—
	4	5	Grey	—	—
	5	6	Pink	—	—
	6	7	Blue	—	—
	7	8	Red	—	—
A2	0	10, 12, 14	Violet	Blue/Red	Brown/Green
	1	10, 12, 14	Violet	Blue/Red	Brown/Green
	2	10, 12, 14	Violet	Blue/Red	Brown/Green
	3	10, 12, 14	Violet	Blue/Red	Brown/Green
	4	10, 12, 14	Violet	Blue/Red	Brown/Green
	5	10, 12, 14	Violet	Blue/Red	Brown/Green
	6	10, 12, 14	Violet	Blue/Red	Brown/Green
	7	10, 12, 14	Violet	Blue/Red	Brown/Green
24V	+A1	9	Black	Blue Terminals with LED indicator	
		11	Grey/Pink	Blue Terminals with LED indicator	
		13	White/Green	Blue Terminals with LED indicator	
	-A2	—	—	Blue Terminals with LED indicator	

Approximate Dimensions

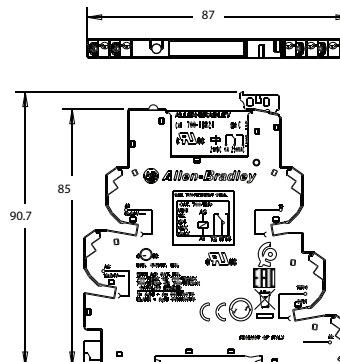
Approximate dimensions are shown in millimeters (inches). Dimensions are not intended for manufacturing purposes.

Figure 46 - 700-HLTN/-HLSN Screw Terminal Design



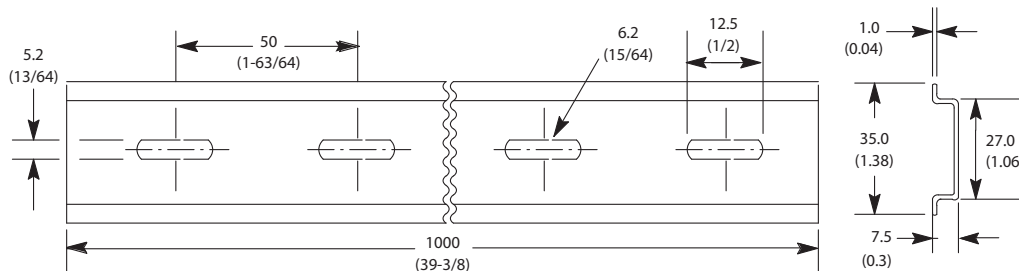
Single Wire: 0.5 mm²...2.5 mm² (#21 AWG...#14 AWG)
 Double wire: 2 x 0.5 mm²...2 x 1.5 mm² (2 x #26 AWG...2 x #16 AWG)
 Wire Type: Solid or stranded, copper only
 Strip Length: 10 mm (0.4 in)
 Tightening torque: 0.5 N•m (4.4 lb•in)

Figure 47 - 700-HLT/-HLS Spring Terminal Design



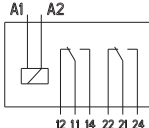


Single Wire: 0.5 mm²...2.5 mm² (#21 AWG...#14 AWG)
 Wire Type: Solid or stranded, copper only
 Strip Length: 9 mm (11/32 in.)

Figure 48 - Cat. No. 199-DR1 DIN Mounting Rail, Series B



700-HL 2-pole Terminal Block Relay

- Relay and socket assembled interface modules for high density interposing or isolation applications
- Screw terminal and spring-clamp bases
- 10 A relay, choice of silver or gold contacts
- DPDT (relay)
- Built-in retainer clip and snap-in marker lever
- Standard LED, reverse polarity protection, and surge protection
- Externally replaceable relay modules





		
Output Type	DPDT (2 C/O); $I_{th} = 10\text{ A}$	
Recommended Tightening Torque	0.6 N•m max (5.3 lb•in)	
Wire Range	Screw Terminal: 0.2...2.5 mm ² (#24...14 AWG), Spring Terminal: 0.2...2.5 mm ² (#24...14 AWG)	
Approvals	cULus, cURus, CE	

Product Selection

Input Voltages	Pkg. Quantity	Cat. No. ⁽¹⁾ (Screw Terminals)	Cat. No. (Spring Clamp Terminals)
12V DC	10	700-HLT12Z12	700-HLT22Z12
24V DC	10	700-HLT12Z24	700-HLT22Z24
48V DC	10	700-HLT12Z48	700-HLT22Z48
24V AC/DC	10	700-HLT12U24	700-HLT22U24
110/125V AC/DC	10	700-HLT12U1	700-HLT22U1
220...240V AC/DC	10	700-HLT12U2	700-HLT22U2

(1) For Gold-plated contacts: Add the letter "X" at the end of the catalog number. Example: Cat. No. 700-HLT12Z24 with gold plated contacts is Cat. No. 700-HLT12Z24X. The following relays are available with the gold-plated contact option: 700-HLT_22Z4, 700-HLT_22U24, 700-HLT_22U1, and 700-HLT_22U2. Not available on 12V and 48V DC products.

Accessories

Photo	Description	Pkg. Qty.	Socket Input Voltage/Color	Cat. No.
	Replacement Relays • Order must be for 20 relays or multiples of 20.	20	12V DC	700-TBR212
			24V AC/DC	700-TBR224
			48V DC	700-TBR248
			110/125V AC/DC, 220...240V AC/DC	700-TBR2110
	8-Way Jumper • Can be cut to required length • $I_{th} = 10\text{ A}$ max per 8-way jumper.	1	Red	700-TBJ08R
			Grey	700-TBJ08G
			Blue	700-TBJ08B
	End Barrier • Used for visual inspection of groups, safe separation of neighboring 700-HL modules that end with jumpers.	10	Black	700-HN177
	Snap-in Marker ⁽¹⁾ • 6 x 12 mm surface • snaps into the ejection lever for the relay	100	Blank	1492-MS6X12

(1) For custom markers, contact your local Rockwell Automation sales office or Allen-Bradley distributor for more information.

Specifications

Table 57 - Electrical Ratings

Attribute			700-HL 2-Pole Relay		
Pilot Duty Rating ⁽¹⁾			NEMA B300, R300		
Rated Thermal Current (I_{th})			2-Pole – 10 A		
Rated Insulation Voltage (U_i)			IEC	250V	
			UL/CSA	300V	
Contacts	Inductive	AC (UL)	120V AC	AC-15, 3.0A; B 300, 3.0 A 1/4 Hp (186 W), 1-phase	
			240V AC	AC-15, 3.0 A; B 300, 1.5 A 1/2 Hp (373 W), 1-phase	
		DC (DC-13)	24V DC	2.0 A	
			125V DC	0.3 A	
	240V DC		0.2 A		
	Resistive • Make, Break, and Continuous	250V AC		10 A	
		24V DC		10 A	
		250V DC		0.28 A	
	Inductive Load			AC-15 250V, 3 A N.O. Contact, 1.5 A N.C. Contact DC-13 24V, 1 A N.O., and N.C. Contact	
	Min Permissible Contact Ratings			Silver Contacts	12V, 10 mA (120 mW)
Gold Contacts				5V, 1 mA (50 mW)	
Permissible Coil Voltage Variation			Pickup	50 Hz	85...110% of Nominal Voltage
				60 Hz	85...110% of Nominal Voltage
				DC	80...110% of Nominal Voltage
			Must Drop out	AC	10% of Nominal
				DC	5% of Nominal Voltage
Design Specification/Test Requirements	Electrical	Dielectric Withstand Voltage	Pole to Pole (VRMS)	1000V	
			Contact to Coil (VRMS)	5000V	
			Adjacent Contacts (VRMS)	2500V	
	Electrical Life (Operating)	250V AC/24V DC	8 A Resistive	100,000 min	
			10 A Resistive	6000 min	
		24V DC	0.28 A Resistive	6000 min	
			10 A Resistive	30 000 min	
	Impedance at input voltage:	12V AC/DC		1 k Ω	
		24V AC/DC		2 k Ω	
		48V DC		3 k Ω	
		120V AC/DC		34 k Ω	
		240V AC/DC		72 k Ω	
	Power Consumption $\pm 10\%$	AC	12V AC/DC		–
			24V AC/DC		0.5VA
			48V DC		–
			120V AC/DC		0.4VA
			240V AC/DC		0.8VA
		DC	12V AC/DC		0.4 W
			24V AC/DC		0.5 W
			48V DC		0.8 W
120V AC/DC			0.5 W		
240V AC/DC			0.7 W		

(1) See [NFMA Ratings and Test Values on page 5](#)

Table 58 - Mechanical Ratings

Attribute		700-HL 2-Pole Relay
Degree of Protection (Open Type) IEC 529		IP 20
Mechanical Lifecycles (AC/DC)		3x 10 ⁷
Switching Frequency Operations (no-load)		1200 cycles/s
Coil Voltages		See page 68
Operating Time at Nominal Voltage at 20 °C	Pickup	typical 10 ms
	Dropout	typical 10 ms
Maximum Operating Rate (full load = 6 A)		6 cycles/min
Coil Surge Protection		Per EN 61000-4.5; Surge Immunity (801-5) Class III: 2 kV common and 1 kV differential mode

Table 59 - Environmental Ratings

Attribute			700-HL 2-Pole Relay
Temperature	Operating	[°C]	-40...+60
		[°F]	-40...+140
	Storage	[°C]	-40...+100
		[°F]	-40...+212
Altitude			2000 m (6560 ft)

Table 60 - Construction

Attribute	700-HL 2-Pole Relay
Insulating Material	Molded High-Dielectric Material
Enclosure	Relay RT II – flux-proof, pollution degree 2 installation environment
Contact Material	AgNi 90/10 or AgNi 90/10 + Au
Terminal Markings on Socket	In accordance with EN50 0005

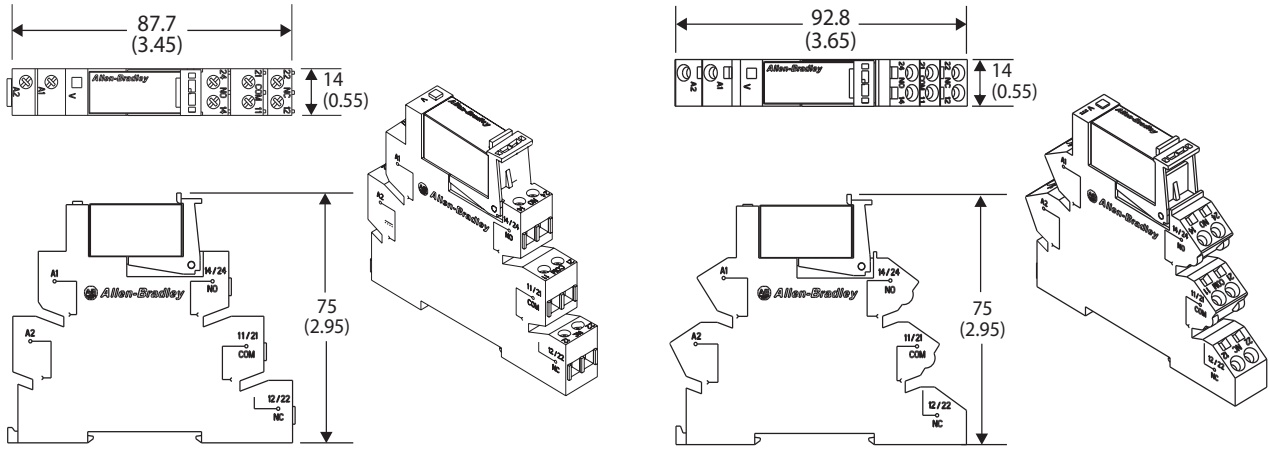
Table 61 - Standards Compliance and Certifications

Attribute	700-HL 2-Pole Relay
Certifications	<ul style="list-style-type: none"> cULus Listed (File No. E3125, Guide NRNT/NRNT7) CE Marked
Standards Compliance	<ul style="list-style-type: none"> UL508 CSA C22.2, No. 14 EN 61810-1

Approximate Dimensions

Approximate dimensions are shown in millimeters (inches). Dimensions are not intended for manufacturing purposes.

Figure 49 - 700-HL 2-Pole Relays



Bulletin 700-HL Screw Terminal Design

Single Wire: 0.14 mm²...2.5 mm² (#26 AWG...14 AWG)

Double Wire: 2 x 0.14 mm²...2 x 1.5 mm² (2 x #26 AWG...2 x 16 AWG)

Wire Type: Solid or stranded, copper only

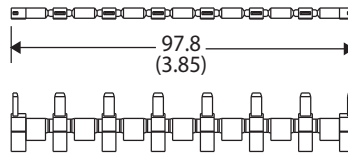
Strip Length: 9 mm (11/32 in). Torque: 0.5 N•m (4.4 lb•in)

Bulletin 700-HL Spring Terminal Design

Single Wire: 0.2 mm²...2.5 mm² (#24 AWG...#14 AWG)

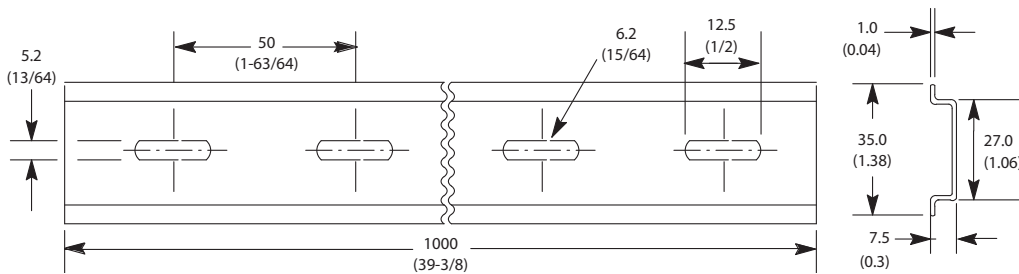
Wire Type: Solid or stranded, copper only

Strip Length: 9 mm (11/32 in)



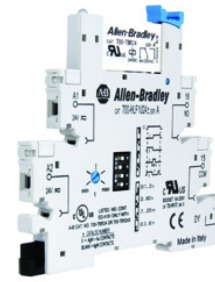
Bulletin 700-TBJ08_ 8-Way Jumper

Figure 50 - Cat. No. 199-DR1 DIN Mounting Rail, Series B



700-HLF Terminal Block Timing Relay

- Relay and socket assembled modules for high-density applications
- Screw terminal bases
- 6 A relay, choice of silver or gold contacts
- SPDT (relay)
- Four timing functions
- Time range from 0.1 sec...6 hr
- Built-in retainer clip and snap-in marker lever
- Standard LED, reverse polarity protection, and surge protection
- Externally replaceable relay modules



Wiring Diagram	
Output Type	SPDT (1 C/O); $I_{th} = 6A\text{§}$
Recommended Tightening Torque	0.5 N•m max (4.4 lb•in)
Wire Range	Screw Terminal: 0.14 mm ² ...2.5 mm ² (#26...#14 AWG)
Approvals	cULus, cURus, CE

Product Selection

Assembled Device		
Input Voltage	Pkg. Quantity	Cat. No. ⁽¹⁾
24V AC/DC	10	700-HLF1U24

(1) For gold-plated contacts add an X after the catalog number listed.

Accessories

Terminal block timing relay bases are not sold separately.

Photo	Description	Pkg. Quantity	Socket Input Voltage	Cat. No.
	Replacement Relays • Order must be for 20 relays or multiples of 20.	20	24V AC/DC	700-TBR24 ⁽¹⁾
	20-Way Jumper • Can be cut to required length • $I_{th} = 36 A$ max per 20-way jumper.	1	Red	700-TBJ20R
			Grey	700-TBJ20G
			Blue	700-TBJ20B
	End Barrier • Used for visual inspection of groups, safe separation of neighboring 700-HL modules that end with jumpers.	10	Black	700-HN177
	Snap-in Marker ⁽²⁾ • 6 x 10 mm surface • snaps into the ejection lever for the relay	100	Blank	1492-MC6X10

(1) For gold-plated contacts: Add the letter "X" at the end of the catalog number. For example: if Cat. No. 700-TBR24 is required with gold plating, the new cat. no. is 700-TBR24X.

(2) For custom markers, contact your local Rockwell Automation sales office or Allen-Bradley distributor for more information.

Function and Connection Diagrams

Figure 51 - On-delay

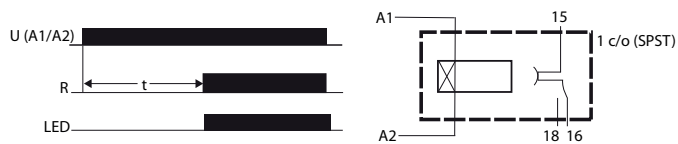


Figure 53 - Pulse

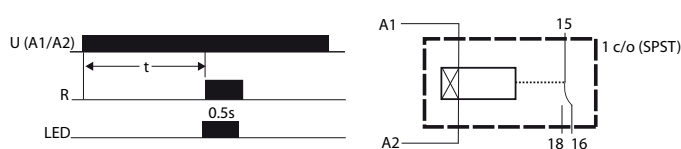


Figure 52 - One Shot

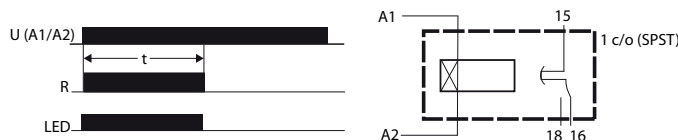
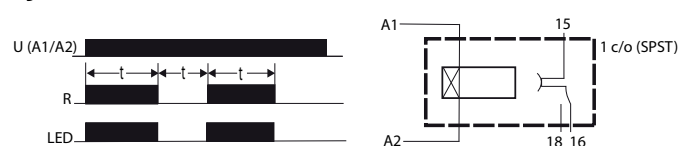


Figure 54 - Flasher



Specifications

Table 62 - Electrical Ratings

Attribute		700-HLF... (Relay Output) ⁽¹⁾			
Pilot Duty Rating ⁽²⁾		NEMA B300, R300			
Rated Thermal Current (I_{th})		1-Pole – 6 A			
Rated Insulation Voltage (U_i)		IEC	250V		
		UL/CSA	300V		
Contacts	Inductive	Contact Type			
		AC	Make	Break	
			▶ ◀	◀ ▶	
	24V AC, 1-phase		30 A	5 A	
	120V AC, 1-phase	30 A	3 A		
	240V AC, 1-phase	15 A	1.5 A		
Resistive • Make, Break, and Continuous	24V DC	1.0 A			
	120V DC	0.2 A			
	240V DC	0.1 A			
Inductive Load		AC-15 250V, 3 A N.O. Contact, 1.5 A N.C. Contact DC-13 24V, 1 A N.O. and N.C. Contact			
Min Permissible Contact Ratings		Silver Contacts	12V, 6 mA (72 mW)		
		Gold Contacts	8V, 2.5 mA (20 mW)		
Permissible Coil Voltage Variation		Pickup	50 Hz	85...110% of Nominal Voltage	
			60 Hz	85...110% of Nominal Voltage	
		Must Drop out	DC	80...110% of Nominal Voltage	
			AC	10% of Nominal	
DC		5% of Nominal Voltage			
Power Consumption ±10%		AC/DC	0.5 VA		
Design Specification/Test Requirements		Electrical	Dielectric Withstand Voltage	Pole to Pole (VRMS)	1000V
				Contact to Coil (VRMS)	4000V
		Input Voltage		24V AC/DC	
		Impedance		2 kΩ	
		Electrical Life (Operating)		6 A Resistive	100,000 min
		24V DC, 1 A Inductive	200 000 min		
		120V AC 1 A Inductive	300 000 min		

(1) Product shall be installed in an enclosure providing at least IP54 protection. Provisions shall be made to prevent the rated voltage from being exceeded by transient disturbances of more than 40%.

(2) See [NEMA Ratings and Test Values on page 5](#)

Table 63 - Mechanical Ratings

Attribute		700-HLF... (Relay Output)
Degree of Protection (Open Type) IEC 529		IP 20
Mechanical Lifecycles (AC/DC)		1 x 10 ⁷
Switching Frequency Operations (no-load)		10 cycles/s
Coil Voltages		See page 72
Operating Time	Pickup	6 ms
	Dropout	6 ms
Maximum Operating Rate (full load = 6 A)		6 cycles/min
Coil Surge Protection		Per EN 61000-4.5; Surge Immunity (801-5) Class III: 2 kV common and 1 kV differential mode
Timer	Function	On-delay, One Shot, Pulse, and Flasher
	Settings	0.1...3 s, 3...60 s, 1...20 min, and 0.3...6 hr
	Adjustments	Min and Max adjustments with Potentiometer
	Accuracy	Repeatability 1%, Recovery Time < 50 ms, Setting Accuracy Full Range 5%

Table 64 - Environmental Ratings

Attribute			700-HLF... (Relay Output)
Temperature	Operating	[°C]	-40...+55
		[°F]	-40...+131
	Storage	[°C]	-40...+100
		[°F]	-40...+212
Altitude			2000 m (6560 ft)

Table 65 - Construction

Attribute	700-HLTN Relay
Insulating Material	Molded High-dielectric Material
Enclosure	Relay IP67
Contact Material	Silver Tin Oxide, AgSnO ₂ or Silver with Gold Plating, AgSnO ₂ + Au
Terminal Markings on Socket	In accordance with EN50 0005

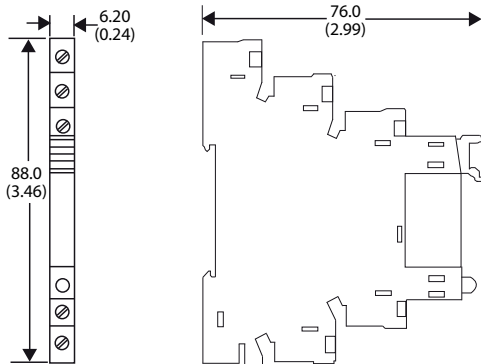
Table 66 - Standards Compliance and Certifications

Attribute	700-HLTN Relay
Certifications	<ul style="list-style-type: none"> cULus Listed (File No. E3125, Guide NLDX/NLDX7) with Allen-Bradley socket CE Marked
Standards Compliance	<ul style="list-style-type: none"> EN60947-4-1 EN60947-5-1 CSA 22.2 UL 508 NEMA IEE MAC Compliant ICS-2 Compliant

Approximate Dimensions

Approximate dimensions are shown in millimeters (inches). Dimensions are not intended for manufacturing purposes.

Figure 55 - 700-HLF Screw Terminal Design



Single Wire: 0.14 mm²...2.5 mm² (#26 AWG...14 AWG)

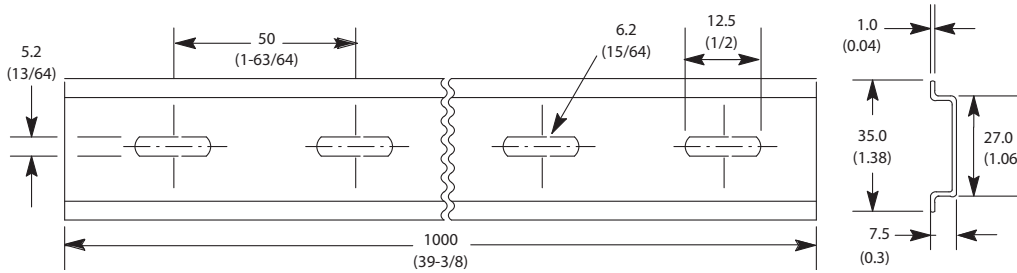
Double Wire: 2 x 0.14 mm²...2 x 1.5 mm² (2 x #26 AWG...2 x 16 AWG)

Wire Type: Solid or stranded, copper only

Strip Length: 9 mm (11/32 in.)

Torque: 0.5 N•m (4.4 lb•in)

Figure 56 - Cat. No. 199-DR1 DIN Mounting Rail, Series B



700-HP Slim Line Relay

- 8 A contact ratings
- DPDT/ (2 c/o) contacts
- Plug-in PIN style (PCB) terminals (5 mm pinning)
- Choice of standard silver nickel contacts, or silver nickel with gold-plated contacts
- Available with mechanically linked contacts (Type B)
- Safety Control Relay Version (700-HPS)


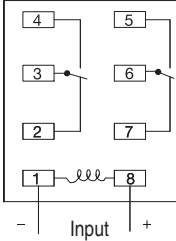
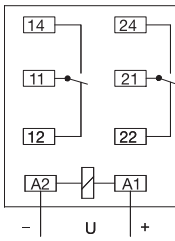


Product Selection

Photo	Description	Contact Rating	Wiring Diagrams		Coil Voltage	Pkg. Qty.	Cat. No.
			U.S./Canada	International			
	DPDT 2-Pole 2 Form C AgNi + Au Gold Plated Contacts	8 A			6V AC	10	700-HPX2A06
					12V AC	10	700-HPX2A12
					24V AC	10	700-HPX2A24
					120V AC	10	700-HPX2A1
					240V AC	10	700-HPX2A2
					6V DC	10	700-HPX2Z06
					12V DC	10	700-HPX2Z12
					24V DC	10	700-HPX2Z24
					48V DC	10	700-HPX2Z48
					110V DC	10	700-HPX2Z1
					6V AC	10	700-HP32A06
					12V AC	10	700-HP32A12
					24V AC	10	700-HP32A24
					120V AC	10	700-HP32A1
					240V AC	10	700-HP32A2
					6V DC	10	700-HP32Z06
					12V DC	10	700-HP32Z12
					24V DC	10	700-HP32Z24
48V DC	10	700-HP32Z48					
Sockets			700-HN123	700-HN123	110V DC	10	700-HP32Z1

700-HPS Safety Control Relay


Product Selection

Photo	Description	Contact Rating	Wiring Diagrams		Coil Voltage	Pkg. Qty.	Cat. No.
			U.S./Canada	International			
	DPDT 2-Pole 2 Form C AgNi + Au Gold Plated Mechanically Linked Contacts	8 A			6V DC	10	700-HPSXZ06
					12V DC	10	700-HPSXZ12
					24V DC	10	700-HPSXZ24
					48V DC	10	700-HPSXZ48
					60V DC	10	700-HPSXZ60
					110V DC	10	700-HPSXZ1
	DPDT 2-Pole 2 Form C AgNi Mechanically Linked Contacts		125V DC	10	700-HPSXZ01		
			6V DC	10	700-HPSZ206		
			12V DC	10	700-HPSZ212		
			24V DC	10	700-HPSZ224		
			48V DC	10	700-HPSZ248		
			60V DC	10	700-HPSZ260		
			110V DC	10	700-HPSZ21		
700-HPS DPDT	Sockets		700-HN123	700-HN123	125V DC	10	700-HPSZ201


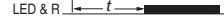
700-HP, -HPS Accessories, Specifications, and Approximate Dimensions

Accessories





Surge Suppressors

	Description	For Use With	Pkg. Qty.	Cat. No.
	Diode Surge Suppressor	700-HN204 and 700-HN205 sockets	10	700-ADR
			10	700-ADL1R
			10	700-ADL2R
			10	700-ADL3R
	Varistor Surge Suppressor with LED		10	700-AV1R
			10	700-AV3R
	RC Surge Suppressor		10	700-AR1
			10	700-AR2

Timing Modules

Photo	Description	Diagram	Cat. No.
	Timing Module <ul style="list-style-type: none"> On-delay or One-Shot used with sockets that accept plug-in accessory modules Pkg. Qty: 1 	On-Delay U (A1/A2)  LED & R	700-AT3
			700-AT3A1
			700-AT3A2



Sockets and DIN Rail

	Description	For Use With	Pkg. Qty.	Cat. No.
	Screw Terminal Socket <ul style="list-style-type: none"> Panel or DIN Rail Mounting 8-pin miniature socket Incorporates coil and contact separation 	2-pole 700-HP relays	10	700-HN123
	Plastic Retainer and Ejection Lever <ul style="list-style-type: none"> Built-in ability to accept 1492 snap-in markers 	700-HN123 sockets	10	700-HN119
	Spring Clamp Terminal Socket <ul style="list-style-type: none"> Panel or DIN Rail Mounting 8-pin miniature socket Incorporates coil and contact separation 	2-pole 700-HP relays	10	700-HN230
	Plastic Retainer and Ejection Lever <ul style="list-style-type: none"> Built-in ability to accept 1492 snap-in markers 	700-HN230 sockets	10	700-HN232
	DIN (#3) symmetrical hat rail <ul style="list-style-type: none"> 35 x 7.5 x 1 m 		10	199-DR1
	8-Way Jumper <ul style="list-style-type: none"> Can be cut to required length 10 A rating @ 250V 	Red	1	700-HN180R
		Grey		700-HN180G
		Blue		700-HN180B

Socket and Retainer Clip Reference

Relay Cat. No.	Socket	Retainer Clip
700-HPX2	700-HN123	700-HN119
700-HP32	700-HN123	700-HN119
700-HPS2	700-HN123	700-HN119
700-HPSX	700-HN123	700-HN119

Marking Systems

Photo	Description	Pkg. Qty.	Cat. No.
	Relay Identification Snap-in Markers <ul style="list-style-type: none"> Snap-in markers fit on top of product covers Squares slip into molded slot on top of product covers Use with Cat. No. 700-N40 or 700-N41 identification tags 	100	1492-MS5X12
			1492-MS6X9
			1492-MS6X12
			1492-MS8X9
			1492-MS8X12
			1492-MP-Blank
	Pre-printed Identification Tags <ul style="list-style-type: none"> Contains 10 sheets of pre-printed and blank tags Each sheet contains 13 sets of the markings CR...9CR, TR...9TR, M...9M, F, R, 1S, and 117 blank tags Tags are peel-off with sticky backing for easy placement on relays 	10	700-N40
	Blank Identification Tags <ul style="list-style-type: none"> contains 10 sheets of blank identification tags for customer specialized printing Each sheet contains 546 blank tags Tags are peel-off with sticky backing for easy placement on relays. 	10	700-N41

Specifications

Table 67 - Electrical Ratings⁽¹⁾

Attribute			Cat. No. 700-HP3..., 700-HPX	Cat. No. 700-HPS
Contacts	Inductive	V AC	AC 15 @ 500V AC	
			C300	B300
			1/3 Hp @ 240V AC	1/2 Hp @ 240V AC
			1/6 Hp @ 120V AC	1/3 Hp @ 120V AC
			AC-1 2000VA	
	V DC ⁽²⁾	R300	—	
		DC-1: 8A @ 30V DC		
		DC-1: 0.3A @ 110V DC	DC-1: 0.65A @ 110V DC	
		DC-1: 0.1A @ 220V DC	DC-1: 0.2A @ 220V DC	
	Resistive	AC	8 A @ 277V AC (per pole)	
DC		8 A @ 30V DC (per pole)		
Minimum Load		700-HP32: 300mW (5V, 5 mA) 700-HPX2: 50mW (5V, 5 mA)	700-HPS2: 500 mW (10V, 10 mA) 700-HPSX: 50 mW (5V, 5 mA)	
Nominal Coil Power (AC/DC)			1.2 VA / 0.65 W	0.7 W
Operating Range (AC/DC)			80...110% / 73...150% Nominal Voltage	75...120% Nominal Voltage DC
Holding Voltage (AC/DC)			80 / 40% Nominal Voltage	40% Nominal Voltage DC
Must Drop Out Voltage (AC/DC)			20 / 10% Nominal Voltage	10% Nominal Voltage DC
Insulation Voltage			250V AC	
Design Specification/Test Requirements	Electrical	Dielectric Withstand Voltage	Pole to Pole (VRMS)	2000V AC
			Contact to Coil (VRMS)	4000V AC

(1) The inrush VA equals 1.5 times the sealed VA.

(2) In the case of DC-13 loads, the connection of a diode in parallel with the load will permit a similar electrical life as for a DC-1 load

Table 68 - Mechanical Ratings

Attribute		Cat. No. 700-HP3..., 700-HPX	Cat. No. 700-HPS
Degree of Protection		Open Type (Sockets)	
Mechanical Lifecycles (AC/DC)	AC	1×10^7	—
	DC	2×10^7	1×10^7
Switching Frequency Operations (no-load)		1800/h	900/h
Coil Voltages		See page 76	See page 77
Operating Time	Pickup	12 ms	10 ms
	Dropout	4 ms	4 ms
Maximum Operating Rate (full load = 6 A)		16 Ops/s	8 Ops/s
Vibration	Enclosure	5 G	
	Fragility	2.5 G	
Shock	Endurance	50 G	
	Fragility	15 G	
Max Socket Torque		0.5 N•m (4.4 lb•in)	

Table 69 - Environmental Ratings

Attribute			Cat. No. 700-HP3..., 700-HPX	Cat. No. 700-HPS
Temperature	Operating	[°C]	-40...+85	-40...+70
		[°F]	-40...+185	-40...+158
	Storage	[°C]	-45...+100	-50...+80
		[°F]	-49...+212	-58...+176
Altitude			2000 m (6560 ft)	

Table 70 - Construction

Attribute	Cat. No. 700-HP3..., 700-HPX	Cat. No. 700-HPS
Insulating Material	Molded High-Dielectric Material	
Enclosure	Transparent Dust Cover	Red Transparent Dust Cover
Contact Material	Silver Nickel, (AgNi) (700-HP32 and 700-HPS2), Silver Nickel + Gold Plating (AgNi + Au) (700-HPX2 and 700-HPSX)	
Terminal Markings on Socket	In accordance with EN50 0005	
Socket	2-pole, 700-HN123	

Table 71 - Standards Compliance and Certifications

Attribute	700-HP, -HPS Relay
Certifications	<ul style="list-style-type: none"> • cURus Recognized (File No. E3125, Guide NLDX2/NLDX8) • cULus Listed when used with 700-HN123 socket (File No. E3125, Guide NLDX/NLDC7) • CSA Certified (file 229473) • CE Marked • IMQ & TÜV Certified (700- HPS)
Standards Compliance	<ul style="list-style-type: none"> • UL 508 • CSA 22.2 No. 14 • EN 61810-1 • EN-61810-3 Type B 2 C.O. contacts (700-HPS)⁽¹⁾

(1) According to EN 61810-3, only 1 NO and 1 NC (11-14 and 21-22 or 11-12 and 21-24) shall be used as forcibly guided contacts.

Approximate Dimensions

Approximate dimensions are shown in millimeters (inches). Dimensions are not intended for manufacturing purposes.

Figure 57 - 700-HP Relays

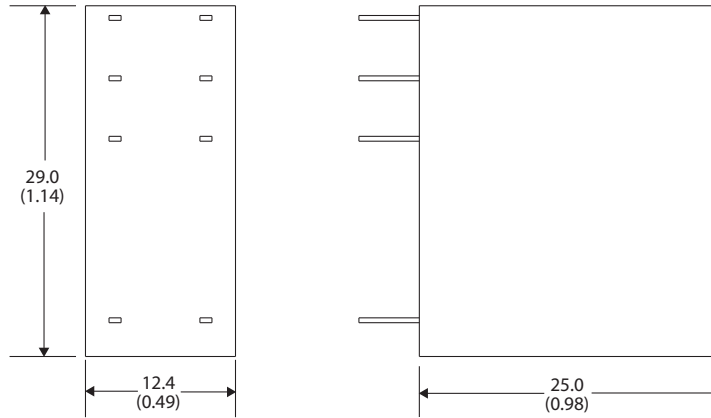


Figure 58 - Cat. No. 199-DR1 DIN Mounting Rail, Series B

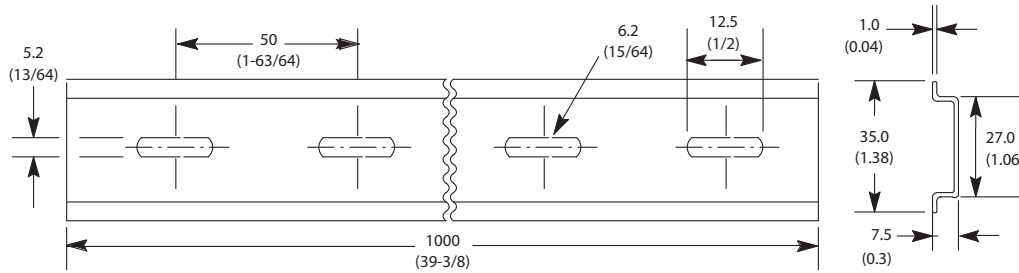
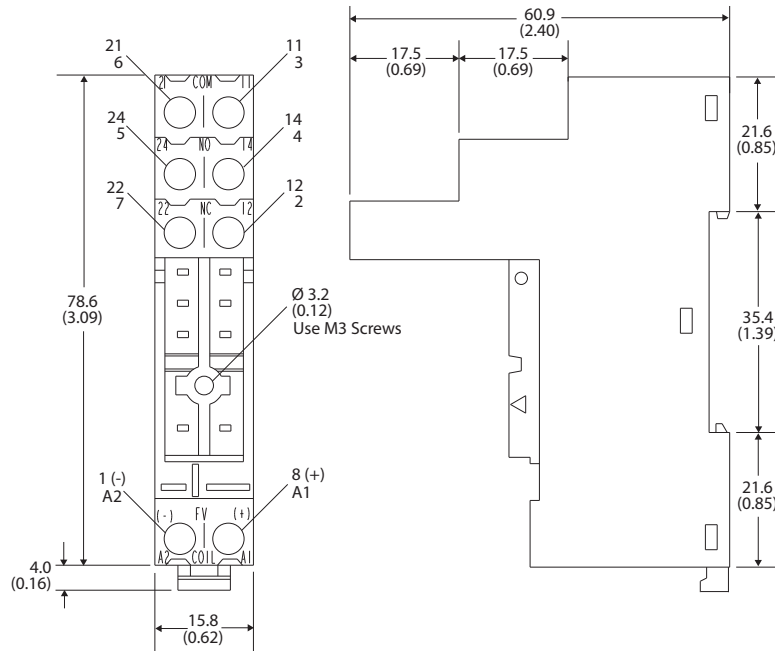
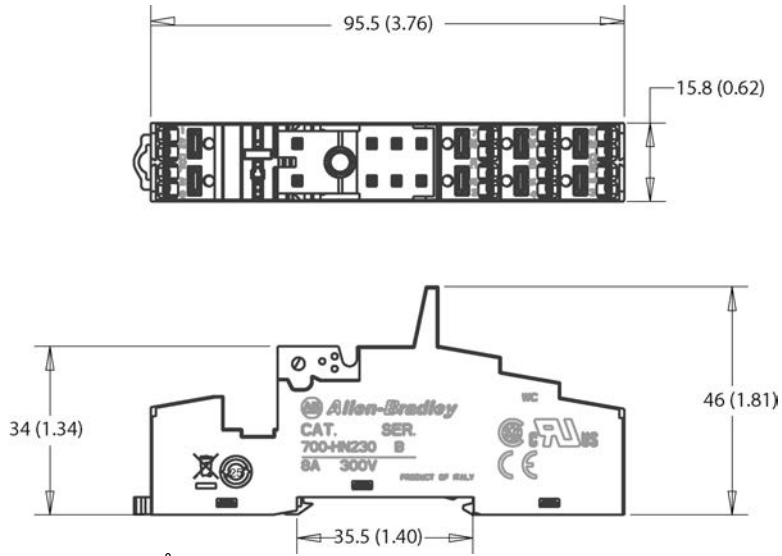


Figure 59 - Cat. No. 700-HN123



Single Wire: 0.2...2.5 mm² (#24...14 AWG)
 Double Wire: 2 x 0.2...2 x 2.5 mm² (#2 X 24...2 X 14 AWG)
 Wire Type: solid or stranded, copper only
 Strip Length: 7 mm (9/32 in.)
 Torque: 0.5 N·m (4.4 lb·in)

Figure 60 - Cat. No. 700-HN230



Min wire size: 0.5mm² (21 AWG.)
 Max wire size: 2 x 1.5 and 1 x 2.5 mm² (2 x 18 / 1 x 14 AWG)
 Wire Type: solid or stranded, copper only
 Stripe Length: 8 mm (10/32 in.)

700-HJ Magnetic Latching Relay



- 10 A Contact Rating
- SPDT
- DPDT Single Coil
- DPDT Dual Coil
- Blade Style Quick Connect Terminals





Product Selection

Photo	Description	Contact Rating	Wiring Diagrams		Coil Voltage	Cat. No.
			AC ⁽¹⁾	DC ⁽²⁾		
	SPDT 1-Pole 1 Form C AgCdO Contacts (Single Coil AC or DC)	10 A			24V AC	700-HJ36A24
			700-HN153	700-HN154	120V AC	700-HJ36A1
	Sockets				24V DC	700-HJ36Z24
	DPDT 2-Pole 2 Form C AgCdO Contacts (Single Coil AC or DC)	10 A			24V AC	700-HJ32A24
			700-HN153	700-HN154	120V AC	700-HJ32A1
	Sockets				240V AC	700-HJ32A2
						12V DC
					24V DC	700-HJ32Z24
	DPDT 2-Pole 2 Form C AgCdO Contacts (Dual Coil) ⁽³⁾	10 A	DC Only		24V DC	700-HJD32Z24
Sockets						700-HN153 or 700-HN154

(1) AC Relays include internal diodes.
 (2) For DC operation, polarity must be observed.
 (3) Available only in DC Coil with DPDT contacts.

Accessories


Sockets and DIN Rail

	Description	For Use With	Pkg. Qty.	Cat. No.
	Screw Terminal Socket <ul style="list-style-type: none"> Panel or DIN Rail Mounting Guarded Terminal Construction 11-blade Coil and contact separation Can be used with optional plug-in modules (700-A... accessories, LED, surge suppression, timing modules) 	700-HJ relays	10	700-HN153
	Screw Terminal Base Sockets <ul style="list-style-type: none"> Panel or DIN Rail Mounting Open Style Construction 11-blade 	700-HJ relays	10	700-HN154
	DIN (#3) symmetrical hat rail <ul style="list-style-type: none"> 35 x 7.5 x 1 m 		10	199-DR1
	Retainer Clip <ul style="list-style-type: none"> Secures relay in socket Order must be for 10 clips or multiples of 10. 	700-HN153 and -HN154 Sockets with 700-HJ Relays	10	700-HN159

Socket and Retainer Clip Reference

Relay Cat. No.	Socket	Retainer Clip
700-HJ	700-HN153	700-HN159
	700-HN154	700-HN159

Marking Systems

Photo	Description	Pkg. Qty.	Cat. No.
	Pre-printed Identification Tags <ul style="list-style-type: none"> Contains 10 sheets of pre-printed and blank tags Each sheet contains 13 sets of the markings CR...9CR, TR...9TR, M...9M, F, R, IS, and 117 blank tags Tags are peel-off with sticky backing for easy placement on relays 	10	700-N40
	Blank Identification Tags <ul style="list-style-type: none"> contains 10 sheets of blank identification tags for customer specialized printing Each sheet contains 546 blank tags Tags are peel-off with sticky backing for easy placement on relays. 	10	700-N41

Specifications

Table 72 - Electrical Ratings

Attribute			700-HJ Relay		
Pilot Duty Rating			—		
Rated Thermal Current (I_{th})			10 A		
Rated Insulation Voltage (U_i)		IEC	250V		
		UL/CSA	300V		
Contacts	Inductive		Make	Break	Hp
			► ◄	◄ ►	—
		120V AC	30 A	3 A	1/4
		240V AC	15 A	1.5 A	1/3
	24V DC	10 A			
Permissible Coil Voltage Variation	Pickup	50 Hz	80...110% of nominal voltage		
		60 Hz	80...110% of nominal voltage		
		DC	80...110% of nominal voltage		
Coil Consumption $\pm 10\%$	AC Coils	Inrush	Single AC coil	1.44VA ()	
		Sealed	Single AC coil	1.44VA (Single AC coil)	
	DC Coils	Single DC coil		1.2 W	
		Dual DC coil	12V DC	1.63 W	
			24V DC	1.67 W	
Design Specification/Test Requirements	Electrical	Dielectric Withstand Voltage	Pole-to-Pole	1500V	
			Contact to Coil	1500V	
			Contact to Frame	1500V	

Table 73 - Mechanical Ratings

Attribute		700-HJ Relay	
Degree of Protection		Open Type (Guarded Terminal Sockets)	
Mechanical Life Operations (AC/DC)		$> 1 \times 10^7$	
Switching Frequency Operations		1800/h	
Coil Voltages		See page 83	
Operating Time	Pickup	25 ms	
	Dropout	25 ms	
Maximum Operating Rate		—	

Table 74 - Environmental Ratings

Attribute			700-HJ Relay	
Temperature	Operating	[°C]	-45...+50	
		[°F]	-49...+122	
	Storage	[°C]	-40...+100	
		[°F]	-40...+212	
Altitude			2000 m (6560 ft)	

Table 75 - Construction

Attribute	700-HJ Relay	
Insulating Material	Molded High-Dielectric Material	
Enclosure	Transparent Dust Cover	
Contact Material	AgCdO	
Terminal Markings on Socket	In accordance with EN50 0005	
Sockets	700-HN153, -HN154	

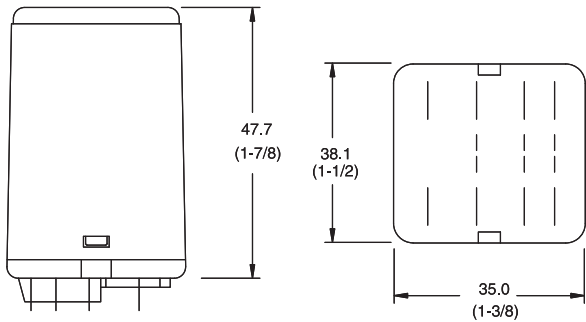
Table 76 - Standards Compliance and Certifications

Attribute	700-HJ Relay
Certifications	<ul style="list-style-type: none"> • CSA Certified, File LR700026 • UL Recognized, File E3125, Guide NLDX 2
Standards Compliance	<ul style="list-style-type: none"> • UL508 • CSA C22.2 No. 14, • EN/IEC 60947-4-1, -5-1

Approximate Dimensions

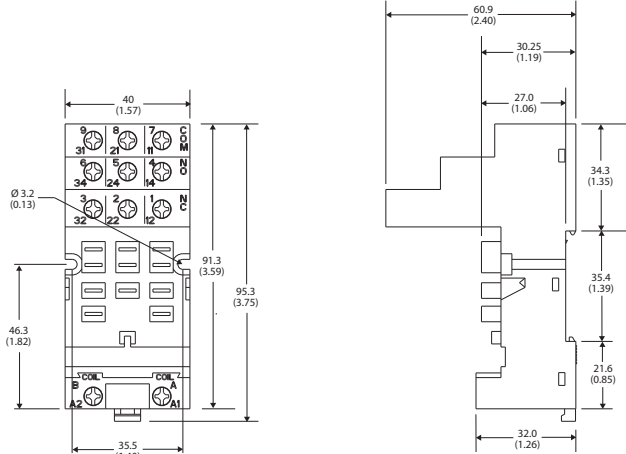
Approximate dimensions are shown in millimeters (inches). Dimensions are not intended for manufacturing purposes.

Figure 61 - 700-HJ Relay



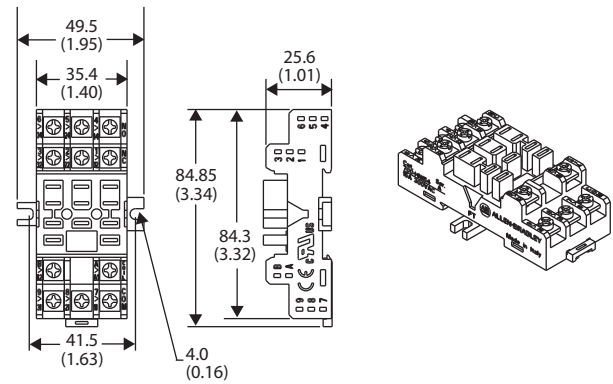
Sockets

Figure 62 - Cat. No. 700-HN153



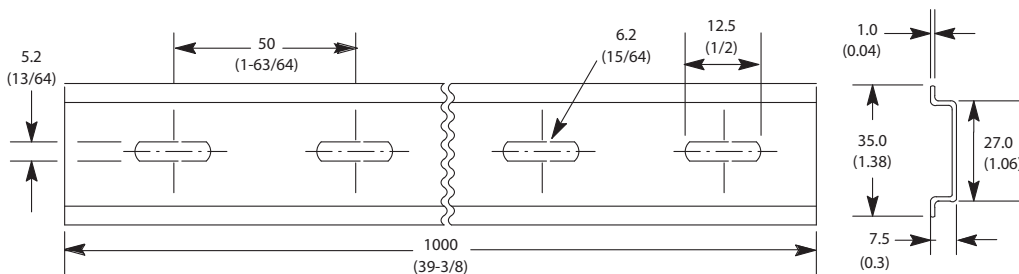
Wire Size: 2 x 2.5 mm²
 Single Wire - Up to #12 AWG
 Double Wire - 2 x 2.5 mm² (#14 ...20 AWG) (Either Solid or Stranded)
 Strip Length: 9 mm (3/8 in.) - Torque: 0.8 N•m (7 lb•in)

Figure 63 - Cat. No. 700-HN154



Wire Size: 2 x 2.5 mm²
 Single Wire - Up to #12 AWG
 Double Wire - 2 x 2.5 mm² (#14 ...20 AWG) (Either Solid or Stranded)
 Strip Length: 9 mm (3/8 in.) - Torque: 0.8 N•m (7 lb•in)


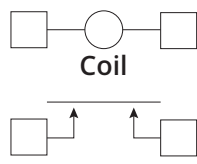

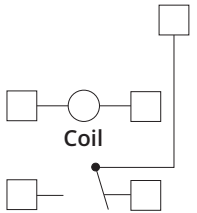

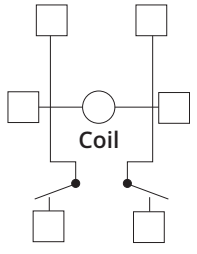

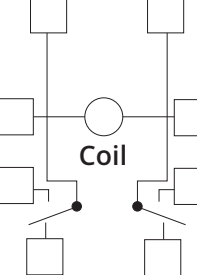
Figure 64 - Cat. No. 199-DR1 DIN Mounting Rail, Series B



700-HG Power Relay

- 40 A Contact Ratings
- SPST-NO-DM, SPDT, DPST-NO, DPDT
- Panel Mounted
- Options: Magnetic Blowout for High DC Loads, Auxiliary Snap Action Switch
- Screw Terminals #6-32 for Coil, #8-32 for Contacts

Product Selection


	Description	Contact Ratings	Wiring Diagrams	Coil Voltage	Cat. No. ⁽¹⁾
	SPST-NO-DM 1 Form X AgCdO Contacts	40 A (A600)		24V AC	700-HG45A24
				120V AC	700-HG45A1
				240V AC	700-HG45A2
				277V AC	700-HG45A27
				480V AC	700-HG45A4
				12V DC	700-HG45Z12
				24V DC	700-HG45Z24
				48V DC	700-HG45Z48
				110V DC	700-HG45Z1
	SPDT 1-pole 1 Form C AgCdO Contacts	40 A (A600)		24V AC	700-HG46A24
				120V AC	700-HG46A1
				240V AC	700-HG46A2
				12V DC	700-HG46Z12
				24V DC	700-HG46Z24
				48V DC	700-HG46Z48
				110V DC	700-HG46Z1
	DPST-NO 2-pole 2 Form A AgCdO Contacts	40 A (A600)		24V AC	700-HG47A24
				120V AC	700-HG47A1
				240V AC	700-HG47A2
				480V AC	700-HG47A4
				12V DC	700-HG47Z12
				24V DC	700-HG47Z24
				48V DC	700-HG47Z48
				110V DC	700-HG47Z1
	DPDT 2-pole 2 Form C AgCdO Contacts	40 A (A600)		24V AC	700-HG42A24
				120V AC	700-HG42A1
				240V AC	700-HG42A2
				277V AC	700-HG42A27
				12V DC	700-HG42Z12
				24V DC	700-HG42Z24
				48V DC	700-HG42Z48
				110V DC	700-HG42Z1
				220V DC	700-HG42Z2
				250V DC	700-HG42Z25

(1) Auxiliary Snap Switch Option: Add suffix (-5) to the selected 700-HG relay Cat. No., except for the 220V DC add (-5L).


Magnetic Blowout Option: Add suffix (-6) to the selected 700-HG relay Cat. No. (suppresses the arc when switching DC loads - ratings listed below).

Accessories

Enclosure

Photo	Description	Pkg. Qty.	Cat. No.
	Enclosure <ul style="list-style-type: none"> • Type 1 • Knockouts for 1/2 in. and 3/4 in. conduit connections. • Exceeds the minimum clearances required by U.S. standards, resulting in generous wiring spaces 	1	700-HN120

Marking Systems

Photo	Description	Pkg. Qty.	Cat. No.
	Pre-printed Identification Tags <ul style="list-style-type: none"> • Contains 10 sheets of pre-printed and blank tags • Each sheet contains 13 sets of the markings CR...9CR, TR...9TR, M...9M, F, R, 1S, and 117 blank tags • Tags are peel-off with sticky backing for easy placement on relays 	10	700-N40
	Blank Identification Tags <ul style="list-style-type: none"> • contains 10 sheets of blank identification tags for customer specialized printing • Each sheet contains 546 blank tags • Tags are peel-off with sticky backing for easy placement on relays. 	10	700-N41

Auxiliary Snap Action Switch

Contact	Material	Rating	Dielectric Withstand V (1 Min)
SPDT (1 Form C)	Silver Cad. Ox.	10 A at 120 or 240 Resistive	1500V AC RMS Contact to Frame

Specifications

Table 77 - Electrical Ratings

Attribute			700-HG Relay				
Pilot Duty Rating ⁽¹⁾			A600				
Rated Thermal Current (I_{th})			40 A				
Rated Insulation Voltage (U_i)			UL	600V			
Contacts	AC Ratings SPST-NO-DM	Inductive	Contact Type	Make	Break	Continuous	Hp
				► ◄	◄ ►	—	—
			120V AC	60 A	6 A	10 A	2
			240V AC	30 A	3 A	10 A	
		480V AC	15 A	1.5 A	10 A		
		600V AC	12 A	1.2 A	10 A		
		Resistive –Make/Break and Continuous	120V AC	40 A			2
			240V AC	40 A			
	480V AC		12 A				
	600V AC		10 A				
	AC Ratings SPDT, DPST - NO and DPDT	Inductive	120V AC	60 A	6 A	10 A	1-1/2
			240V AC	30 A	3 A	10 A	
			480V AC	15 A	1.5 A	10 A	
			600V AC	15 A	1.2 A	10 A	
		Resistive –Make/Break and Continuous	120V AC	40 A			1-1/2
			240V AC	40 A			
			480V AC	5 A			
			600V AC	5 A			
	DC Ratings	Without Magnetic Blowouts		28V 40 A - Make, Break and Continuous Est Drop 125V 1.2...3 A			
		With Magnetic Blowouts		SPST - NO - DM	SPDT, DPST - NO and DPDT		
Make/Break and Continuous		110V	20 A	10 A			
		220V	8 A	4 A			
		325V	4 A	2 A			
	500V	2 A	—				
Permissible Coil Voltage Variation	Pickup		50 Hz	80...110% of nominal voltage			
			60 Hz	80...110% of nominal voltage			
			DC	80...110% of nominal voltage			
Coil Consumption ±10%	AC Coils	Inrush	50 Hz	13 VA			
			60 Hz	16 VA			
		Sealed	50 Hz	10 VA			
			60 Hz	11 VA			
	DC Coils		2.0 W				
Design Specification/Test Requirements	Electrical	Dielectric Withstand Voltage	Pole-to-Pole	2200V			
			Contact to Coil	2200V			
			Contact to Frame	2200V			

(1) See [NEMA Ratings and Test Values on page 5](#)

Table 78 - Mechanical Ratings

Attribute		700-HG Relay
Degree of Protection		Open Type
Mechanical Life Operations (AC/DC)		> 5 x 10 ⁶
Switching Frequency Operations		1600/h
Coil Voltages		See page 87
Operating Time at Nominal Voltage at 20 °C (68 °F)	Pickup	40 ms
	Dropout	35 ms
Maximum Operating Rate		–

Table 79 - Environmental Ratings

Attribute			700-HG Relay
Temperature	Operating	[°C]	-30...+55
		[°F]	-22...+131
	Storage	[°C]	-30...+65
		[°F]	-22...+149
Altitude			2000 m (6560 ft)

Table 80 - Construction

Attribute	700-HG Relay
Insulating Material	Molded Thermo
Enclosure	–
Contact Material	AgCdO
Terminal Markings on Socket	–
Sockets	–

Table 81 - Standards Compliance and Certifications

Attribute	700-HG Relay
Certifications	<ul style="list-style-type: none"> • CSA Certified, File 225674 • UL Listed, File E3125, Guide NLDX • CE Marked
Standards Compliance	<ul style="list-style-type: none"> • UL508 • CSA C22.2 No. 14, • EN/IEC 60947-4-1, -5-1

Approximate Dimensions

Approximate dimensions are shown in millimeters (inches). Dimensions are not intended for manufacturing purposes.

Figure 65 - 700-HG Relay, SPST-NO-DM

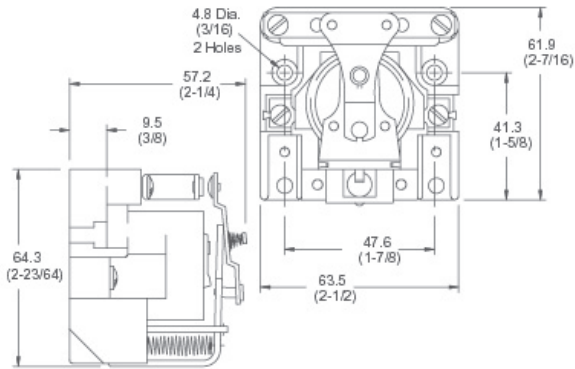
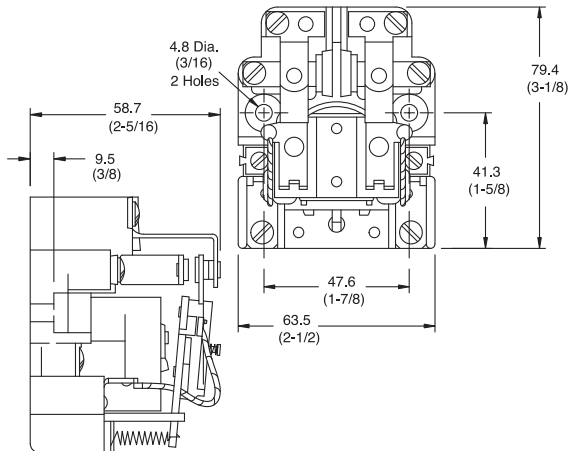



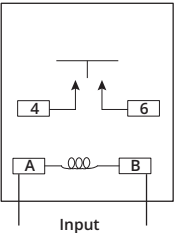
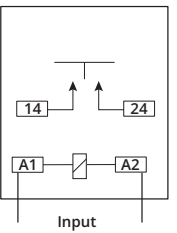
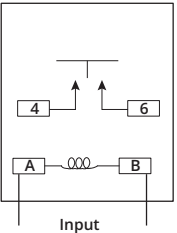
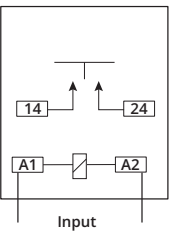
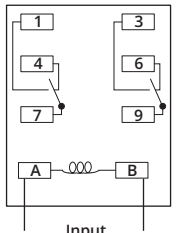
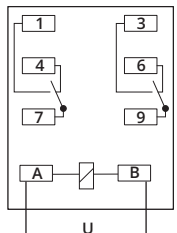
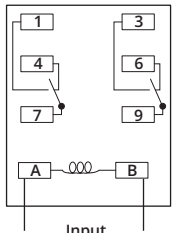
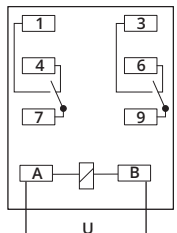
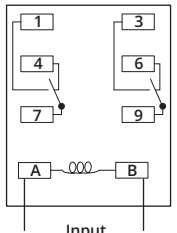
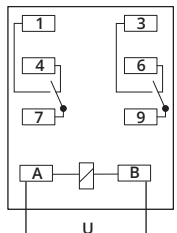
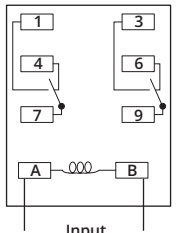
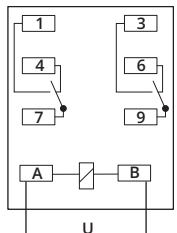
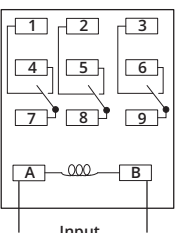
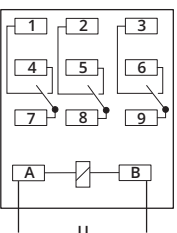
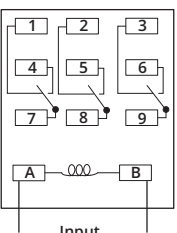
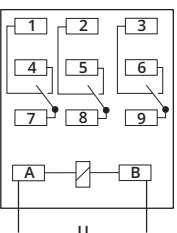
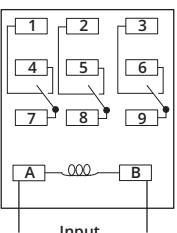
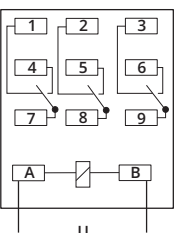
Figure 66 - 700-HG Relay



700-HHF Flange Mount Power Relay

- Flange-Mounted
- Blade Style 0.250 x 0.032 Quick Connect/Solder (no socket) Terminals
- Solder Terminals (no socket)

Product Selection

	Description	Contact Rating	Wiring Diagrams		Coil Voltage	Cat. No.	
			U.S./Canada	International			
	SPST-NO-DM 1 Form X AgCdO Contacts	30 A (A600)			120V AC	700-HHF45A1	
					24V DC	700-HHF45Z24	
	DPDT 2-Pole 2 Form C AgCdO Contacts	25 A (B600)			24V AC	700-HHF62A24	
					120V AC	700-HHF62A1	
					240V AC	700-HHF62A2	
					12V DC	700-HHF62Z12	
	3PDT 3-Pole 3 Form C AgCdO Contacts	20 A (B300)			24V DC	700-HHF62Z24	
							
						120V AC	700-HHF73A1

Specifications

Table 82 - Electrical Ratings

Attribute		700-HHF...									
Pilot Duty Rating ⁽¹⁾		SPST-NO-DM			NEMA A600						
		DPDT			NEMA B600						
		3PDT			NEMA B300						
Rated Thermal Current (I_{th})		SPST-NO-DM 30 A, DPDT 25A, 3PDT 20 A									
Rated Insulation Voltage (U_i)		250V IEC-300V UL/CSA									
Contacts	Inductive	SPST-NO-DM			Hp	DPDT		Hp	3PDT		Hp
		▶ ◀	◀ ▶			▶ ◀	◀ ▶		▶ ◀	◀ ▶	
	120V AC	60 A	6 A	1	30 A	3 A	1	30 A	3 A	1/2	
	240V AC	30 A	3.0 A	1-1/2	15 A	1.5 A	1-1/2	15 A	1.5 A	—	
	DC	28V DC, 30 A			28V DC, 13 A		—				
Permissible Coil Voltage Variation	50 Hz	85...110% of Nominal Voltage									
	60 Hz	85...110% of Nominal Voltage									
	DC	80...110% of Nominal Voltage									

Table 82 - Electrical Ratings (Continued)

Attribute			700-HHF...					
			SPST-NO-DM		DPDT		3PDT	
			50 Hz	60 Hz	50 Hz	60 Hz	50 Hz	60 Hz
Coil Consumption ±10%	AC Coils	Inrush	7.2 VA	6.3 VA	7.2 VA	6.3 VA	7.2 VA	6.3 VA
		Sealed	4.8 VA	4.2 VA	4.8 VA	4.2 VA	4.8 VA	4.2 VA
	DC Coils	1.4 W						
Max Allowable Leakage			25% of VA					
			10% of W					
Design Specification/Test Requirements								
Dielectric Withstand Voltage	Pole-to-Pole		2200V AC					
	Contact-to-Pole		2200V AC					
	Contact-to-Frame		1600V AC					
Mechanical								
Mechanical Life Operations			5 x 10 ⁶					
Switching Frequency Operations			3600/h					
Coil Voltages			See Overview/Product Selection					
Operating Time at Nominal Voltage at 20 °C	Pickup		20 ms					
	Dropout		15 ms					
Maximum Operating Rate			4 Ops/s.					
Environmental								
Temperature	Operating	-30...+50 °C						
		(-22...+122 °F)						
	Storage	-30...+100 °C						
		(-22...+212 °F)						
Altitude			2000 m (6560 ft)					
Construction								
Insulating Material			Molded High Dielectric Material					
Enclosure			Transparent Dust Cover					
Contact Material			Silver Cadmium Oxide					
Terminal Markings			In accordance with EN50 0005					
Sockets			(2)					
Certifications			cURus Recognized, File E3125,Guide NLDX2/NLDX8, CE Marked					
Standards			UL 508, CSA 22.2 No.14, EN/IEC 60947-1, -5-1					

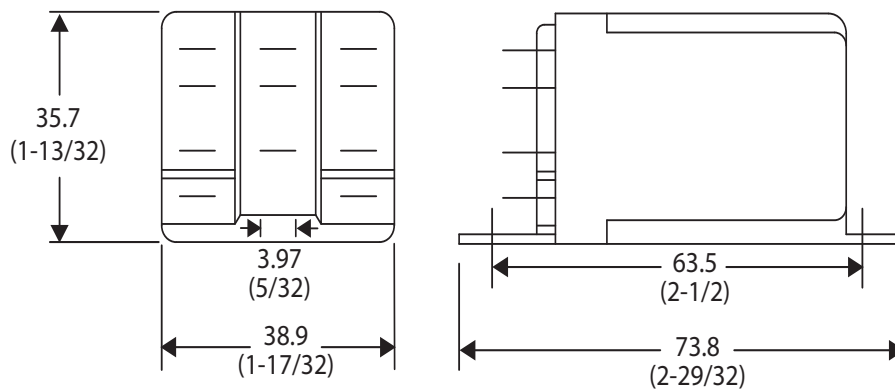
(1) See [NEMA Ratings and Test Values on page 5](#).

(2) 700-HHF relay wiring and terminals are the quick connect / solder type 6.35 x 0.82 mm (0.250 x 0.032 in) termination.

Approximate Dimensions

Approximate dimensions are shown in millimeters (inches). Dimensions are not intended for manufacturing purposes.

Figure 67 - 700-HHF Relay



700-HTA Alternating Relay

- Alternating Relay
- Rugged Pin Style Socket Mounting
- 10 A, SPDT, DPDT, and Cross Wired
- Excellent for Pump Panel Applications



700
-
HTA
2
A12
7

a
b
c
d
e

Catalog Number Explanation








a Bulletin Number	-	b Relay Type	c Model Type	d Coil Voltage	e Gold Plated Contacts Option
700		HTA - Tube Base Alternating Relay	1 SPDT 2 DPDT 3 Cross-Wired	A12 12V AC 50/60 Hz A24 24V AC 50/60 Hz A1 120V AC 50/60 Hz A2 240V AC 50/60 Hz	Blank Without switch 7 With switch

Alternating Relays with Pin-Style Terminations


700-HTA	Alternating Relay	Wiring Diagrams	
		U.S./Canada	International
SPDT Form C Contact	SPDT		
DPDT 2 Form C Contact	DPDT		
Cross-Wired DPDT 2 Form C Contacts	Cross-Wired		

Accessories

Sockets and DIN Rail

	Description	For Use With	Pkg. Qty.	Cat. No.
	Screw Terminal Tube Base Socket • Panel or DIN Rail Mounting • 8-Pin	• Guarded Terminal Construction DPDT 700-HA Relays -HX Timing Relays -HT (On-delay) Timing Relays -HRM, -HRC and -HV (Repeat Cycle) Timing Relays	10	700-HN100
		• Open Style Construction • No retainer clip required DPDT 700-HA Relays -HT (On-delay) Timing Relays -HRM, -HRC and -HV (Repeat Cycle) Timing Relays	10	700-HN125
	Screw Terminal Tube Base Sockets • Panel or DIN Rail Mounting • 11-pin	• Guarded Terminal Construction 3PDT 700-HA Relays	10	700-HN101
		• Open Style Construction • No retainer clip required 3PDT 700-HA Relays	10	700-HN126
	Socket • Can Be Used With or Without Timing Attachment or Surge Suppressor • Screw Terminal Tube Base Sockets • Panel or DIN Rail mounting • Guarded terminal construction	8-Pin DPDT 700-HA Relays	10	700-HN204
		11-Pin 3PDT 700-HA Relays	10	700-HN205
	DIN (#3) symmetrical hat rail • 35 x 7.5 x 1 m		10	199-DR1
	Retainer Clip • Secures relay in socket • Order must be for 10 clips or multiples of 10.		10	700-HN156

Marking Systems

Photo	Description	Pkg. Qty.	Cat. No.
	Pre-printed Identification Tags • Contains 10 sheets of pre-printed and blank tags • Each sheet contains 13 sets of the markings CR...9CR, TR...9TR, M...9M, F, R, 1S, and 117 blank tags • Tags are peel-off with sticky backing for easy placement on relays	10	700-N40
	Blank Identification Tags • contains 10 sheets of blank identification tags for customer specialized printing • Each sheet contains 546 blank tags • Tags are peel-off with sticky backing for easy placement on relays.	10	700-N41

Specifications

Table 83 - Electrical Ratings

Attribute		700-HTA Relay			
Pilot Duty Rating ⁽¹⁾		A600			
Rated Thermal Current (I_{th})		40 A			
Rated Insulation Voltage (U_i)		IEC	250V		
		UL/CSA	300V		
Contacts	Inductive	Contact Type	Make	Break	Hp
		120V AC	▶ ◀	◀ ▶	—
		240V AC	30 A	3 A	1/3
	Resistive	30V DC	15 A	1.5 A	1/2
Permissible Coil Voltage Variation	Pickup	50 Hz	80...110% of nominal voltage		
		60 Hz	80...110% of nominal voltage		
		DC	80...110% of nominal voltage		
Coil Consumption ±10%	AC Coils	24V AC	2 VA		
		120V AC	4 VA		
		240V AC	4 VA		
Design Specification/Test Requirements	Electrical	Dielectric Withstand Voltage	Pole-to-Pole, same circuit (VRMS)		1000V
			Pole-to-Pole, different circuits (VRMS)		1000V
			Contact-to-Coil (VRMS)		2000V
	Electrical Life operations		100,000 minimum		

(1) See [NEMA Ratings and Test Values on page 5](#)

Table 84 - Mechanical Ratings

Attribute		700-HTA Relay
Degree of Protection		Open Type (Guarded Terminal Sockets)
Mechanical Life Operations (AC/DC)		1 x 10 ⁷
Switching Frequency Operations		18,000/h
Coil Voltages		See page 94
Operating Time	Pickup	50 ms
	Dropout	10 ms
Min Cycle Time		100 ms on release of the control switch

Table 85 - Environmental Ratings

Attribute			700-HTA Relay
Temperature	Operating	[°C]	-28...+65, (50 °C max, 240V AC coil)
		[°F]	-18...+149 (122 °F max, 240V AC coil)
	Storage	[°C]	-55...+85
		[°F]	-67...+185
Altitude			2000 m (6560 ft)

Table 86 - Construction

Attribute	700-HTA Relay
Insulating Material	Molded High Dielectric Material
Enclosure	Impact Resistant Dust Cover
Contact Material	AgTnO
Terminal Markings on Socket	In accordance with EN50 005
Sockets	8- or 11-Pin Socket 700-HN100, -HN125 700-HN101, -HN126

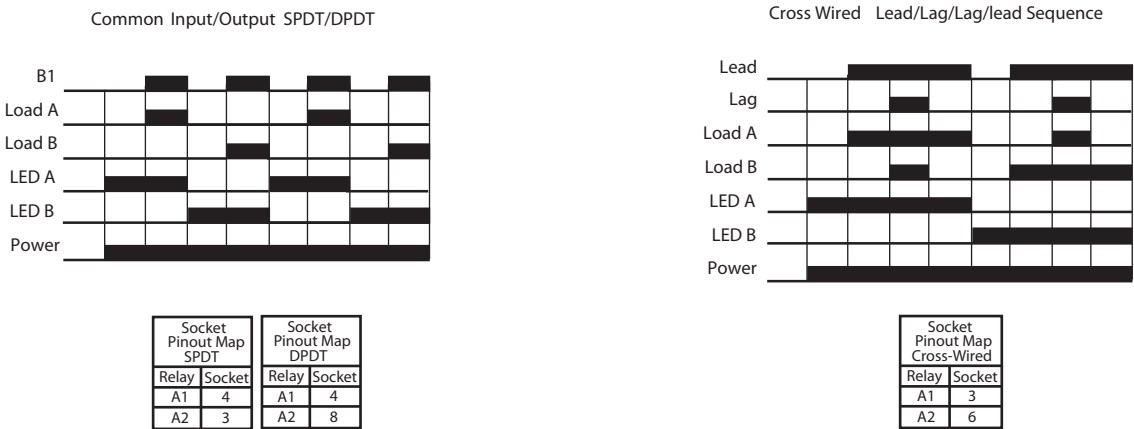
Table 87 - Standards Compliance and Certifications

Attribute	700-HTA Relay
Certifications	<ul style="list-style-type: none"> • CSA Certified, File 223833 • UL Recognized (File E3125 Guide NLDX2/NLDX8) • cULus Listed with 700-HN100, 700-HN101, 700-HN125, and 700-HN126 Sockets (File No. E3125 Guide NLDX/NLDX7) • CE Marked (per EU Low Voltage Directive)
Standards Compliance	<ul style="list-style-type: none"> • UL508 • CSA C22.2 No. 14, • EN 61812-1

Trigger Signal Cat. Nos. 700-HTA

Contact closure provides signal to timer. The 700-HTA alternating relay generates a low energy signal. For optimum reliability, use contacts designed for low energy switching (10V, 1 mA) (Example: Bul. 800F-X_V, 800T-X_V). No external voltage can be connected to the contact signal.

Figure 68 - Load Diagrams - 700-HTA Relays



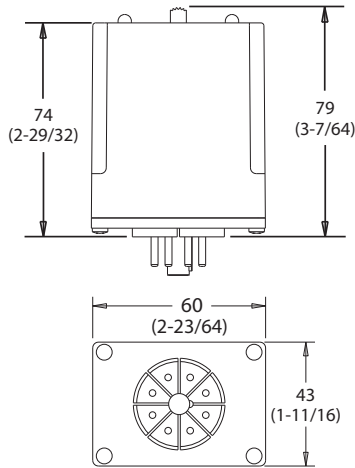
Note: pin out in wiring diagram may not match actual printed socket see pinout map for wiring up the power source

Note: pin out in wiring diagram may not match actual printed socket see pinout map for wiring up the power source

Approximate Dimensions

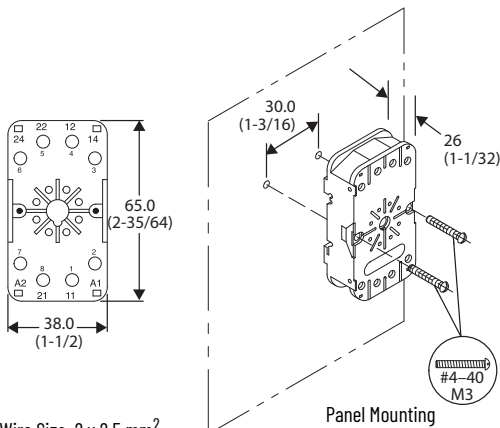
Approximate dimensions are shown in millimeters (inches). Dimensions are not intended for manufacturing purposes.

Figure 69 - 700-HTA Relay



Sockets

Figure 70 - Cat. No. 700-HN100



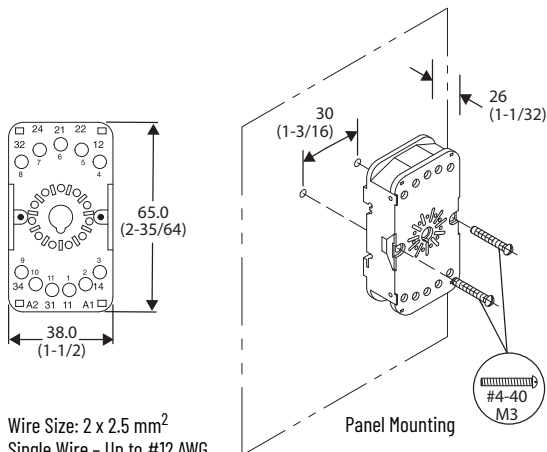
Wire Size: 2 x 2.5 mm²

Single Wire - Up to #12 AWG

Double Wire - 2 x 2.5 mm² (#2...14 AWG... #2...20 AWG) (Either Solid or Stranded)

Strip Length: 9 mm (3/8 in.) - Torque: 0.8 N•m (7 lb•in)

Figure 71 - Cat. No. 700-HN101



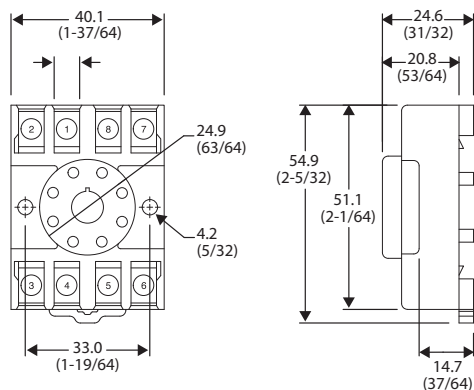
Wire Size: 2 x 2.5 mm²

Single Wire - Up to #12 AWG

Double Wire - 2 x 2.5 mm² (#2...14 AWG... #2...20 AWG) (Either Solid or Stranded)

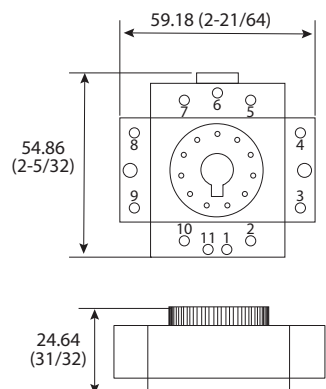
Strip Length: 9 mm (3/8 in.) - Torque: 0.8 N•m (7 lb•in)

Figure 72 - Cat. No. 700-HN125








Wire Size: 2 x 2.5 mm²
 Single Wire - Up to #12 AWG
 Double Wire - 2 x 2.5 mm² (#2...14 AWG... #2...20 AWG) (Either Solid or Stranded)
 Strip Length: 9 mm (3/8 in.) - Torque: 0.8 N•m (7 lb•in)





Figure 73 - Cat. No. 700-HN126






Wire Size: 2 x 2.5 mm²
 Single Wire - Up to #12 AWG
 Double Wire - 2 x 2.5 mm² (#2...14 AWG... #2...20 AWG) (Either Solid or Stranded)
 Strip Length: 9 mm (3/8 in.) - Torque: 0.8 N•m (7 lb•in)

Product Overview

					
Bulletin No.	700-FE	700-FS	700-HR52, -HRP, -HRS, -HRT, -HRV	700-HRM/-HRC	700-HRF
Type	DIN Rail Timer	DIN Rail Timer	Multifunction Timer	On-delay Timer	Twin Timer
Features	<ul style="list-style-type: none"> • Only 17.5 mm wide • 5 A contact rating • Single- and multi-function • No additional socket required 	<ul style="list-style-type: none"> • Only 22.5 mm wide • 5 A contact rating • Single- and multi-function • No additional socket required • Optional: <ul style="list-style-type: none"> - Star-delta timing function - True off-delay timing function - Hazardous location certification 	<ul style="list-style-type: none"> • Dial timing relays • 5 A contact rating • Multiple programmable timing ranges • Tube base pin-style terminals • Multi-voltage inputs • Timed contacts and instantaneous contacts • Transistor outputs • Single- and multi-function • 7 operating modes 	<ul style="list-style-type: none"> • Dial timing relays • 5 A contact rating • Multiple programmable timing ranges • Tube base pin-style terminals • Multi-voltage inputs • Timed contacts and instantaneous contacts • Transistor outputs • Single- and multi-function 	<ul style="list-style-type: none"> • Independent ON and OFF settings • 14 time ranges • 8-pin models available • Dial timing relays • UL508
Control Outputs: Time Limit Instantaneous	SPDT timed	SPDT or DPDT or 2 N.O. + 1 common	DPDT Timed, Transistor SPDT Timed/Instantaneous	DPDT Timed, Transistor SPDT Timed/Instantaneous	DPDT Timed
Operation Modes	On-delay Off-delay One shot Repeat cycle-pulse Fleeting off-delay Pulse converter	12 timing modes	On-delay Off-delay One Shot Repeat Cycle Off Start Repeat Cycle On Start Signal On/Off-delay On-delay One Shot	On-delay	Repeat Cycle Off Start Repeat Cycle On Start
Time Range	0.05 s...100 h	0.05 s...300 h	0.05 s...300 h	0.05 s...300 h	0.05 s...300 h
Supply Voltage	24...48V DC 24...240V AC	24...48V DC 24...240V AC	12...48V DC 24...48V AC 100...240V AC 100...125V DC	12...48V DC 24...48V AC 100...240V AC 100...125V DC	12V DC 24V AC/DC 48...125V DC 100...240V AC
Contact Rating at 120V AC	5 A	5 A	5 A	5 A	5 A
Certifications	CE, cULus	CE, cULus	cURus, CE, C-Tick	cURus, CE, C-Tick	cURus, CE, C-Tick
Socket Cat. No.	DIN Rail or panel mount	DIN Rail or panel mount	700-HN100 OR 700-HN101 700-HN125 OR 700-HN126	700-HN100 700-HN125	700-HN100 700-HN125
Product Selection	103	107	123	123	124

				
Bulletin No.	700-HRY	700-HRQ	700-HNC	700-HNK
Type	Star-Delta Timer	True Off-delay Timer	Miniature Timer	Ultra-Slim Timer
Features	<ul style="list-style-type: none"> • Wide star-time range (up to 120 s) • Star-delta transfer time range (up to 0.5 s) • UL Recognized 	<ul style="list-style-type: none"> • Dial timing relays • Long power Off-delay times • 11-pin and 8-pin models are available • UL Recognized 	<ul style="list-style-type: none"> • Four operating modes • DIN Rail mount with socket • Pin configuration same as 700-HC relay 	<ul style="list-style-type: none"> • Ultra-slim timing relay • Four operating modes • Three operating voltages • DIN Rail mount with socket • Pin configuration same as 700-HK relay
Control Outputs: Time Limit Instantaneous	SPST (Star, Delta) Timed SPST - N.O. Instantaneous	DPDT Timed	4PDT	SPDT, DPST-NO
Operation Modes	Star-Delta	True OFF-delay Timer True OFF-delay Timer w/reset	On-delay One Shot Repeat Cycle Off Start Repeat Cycle On Start	On-delay One Shot Repeat Cycle Off Start Repeat Cycle On Start
Time Range	0.5 s...120 s	0.05 s...12 min	0.1 s...10 h	0.1 s...10 h
Supply Voltage	100...120V AC 200...240V AC	48V DC 24V AC/DC 100...240V AC 100...125V DC	12V DC 24V AC/DC 48...125V DC 100...240V AC	12V DC 24V DC 24V AC
Contact Rating at 120V AC	5 A	5 A	5 A	5 A
Certifications	cURus, CE, C-Tick	cURus, CE, C-Tick	cURus, CSA, CE, C-Tick	cURus, CE, ACA
Socket Cat. No.	700-HN100 700-HN125	700-HN100 OR 700-HN101 700-HN125 OR 700-HN126	700-HN103 700-HN128	700-HN121 700-HN122
Product Selection	103	107	123	123

			
Bulletin No.	700-HT	700-HV	700-HX
Type	Tube Base Timing Relay	Repeat-cycle Timing Relay	Digital Timer
Features	<ul style="list-style-type: none"> Pin-style terminals Single range or fixed timers Available as ON- or OFF-Delay 	<ul style="list-style-type: none"> Pin-style terminals Single-range timer Repeat cycle 	<ul style="list-style-type: none"> Digital timer 5 A contact rating Negative transmissive LCD display 10 functions or modes Environmentally friendly—nonvolatile memory, no battery NEMA B300 rated NEMA 4/IP66 DIN Rail or panel mount capable
Control Outputs: Time Limit Instantaneous	DPDT	DPDT	SPDT
Operation Modes	On-delay Off-delay	Repeat Cycle	Signal On-delay 1 and 2 Signal Off-delay One Shot Repeat Cycle Off Start Repeat Cycle On Start Signal On/Off-delay Power On-delay 1 and 2 Twin Timer Cumulative
Time Range	0.1 s...30 min	0.1 s...30 min	0.05 s...300 h
Supply Voltage	12V DC 24V DC 24V AC 120V AC 240V AC	24V DC 24V AC 120V AC 240V AC	12...24V DC 24V AC 100...240V AC
Contact Rating at 120V AC	10 A	10 A	5 A
Certifications	UR, UL, CSA, CE	UR, UL, CSA, CE	cURus, CE, C-Tick
Socket Cat. No.	700-HN100 OR 700-HN101 700-HN125 OR 700-HN126	700-HN100 700-HN125	700-HN100 700-HN125
Product Selection	103	123	123

700-FE Economy Timing Relay

- Adjustable function and timing range timing relays
- DIN Rail mounted without cost of socket
- 17.5 mm wide, multi-function or single function
- SPDT contact output, 5 A
- Timing ranges from 0.05 s...100 h
- Coil surge protection



Product Selection


Function Type	Operating Mode	Contact Output	Timing Range	Input Voltage	Cat. No.
Multi-function • offers you the flexibility of selecting between 7 single timing functions	ON-delay OFF-delay One Shot Flasher (repeat cycle starting with pulse) Fleeting OFF-Delay Pulse Former Flasher (Repeat Cycle starting with pause)	SPDT (1 C/O)	0.05 s...100 h (7 settings) ⁽¹⁾	24V...48V DC 24...240V AC, 50/60 Hz	700-FEM6TU23
		DPDT (2 C/O)		12...240V AC/DC	700-FEM6TZ12
Single Function • Offers one specific timing function	ON-delay	SPDT (1 C/O)	0.05 s...100 h (7 settings) ⁽¹⁾		700-FEA6TU23
	OFF-delay				700-FEB6TU23
	One Shot				700-FED6TU23
	Flasher (repeat cycle starting with pulse)				700-FEF6TU23
Special Function	Star-Delta	2 N.O. with 1 Common	0.15 s...10 min (4 settings) ⁽²⁾	24V...48V DC 24...240V AC, 50/60 Hz	700-FEY6QU23

(1) Time ranges: 0.05...1 s, 0.5...10 s, 5...100 s, 0.5...10 min, 5...100 min, 0.5...10 h, 5...100 h

(2) Time ranges: 0.05...1 s, 0.5...10 s, 5...100 s, 0.5...10 min

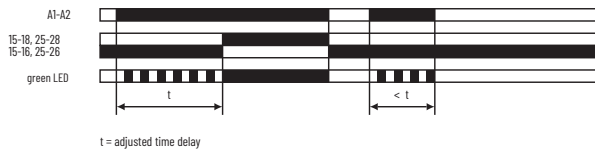
Accessories

Mounting Adapter

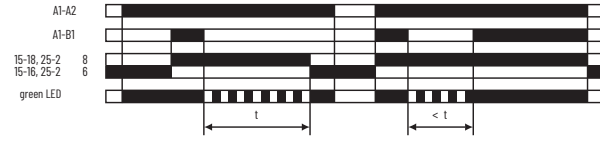
	Description	Pkg. Qty.	Cat. No.
	Panel Mounting Adapter • for surface mounting according to EN 50 002	5	199-FSA

Function Diagrams - 700-FE Relays

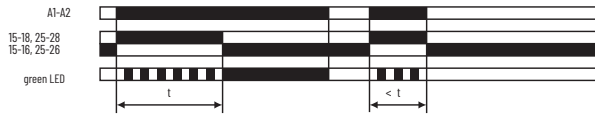
(A) On-delay



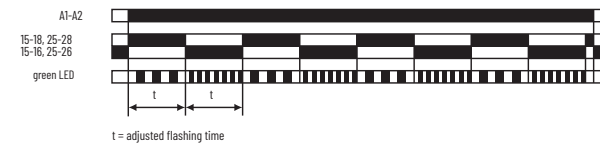
(B) Off-delay



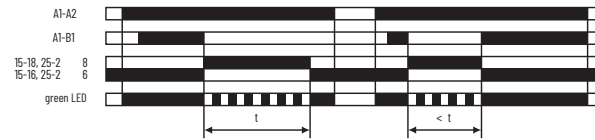
(D) One Shot [Impulse On]



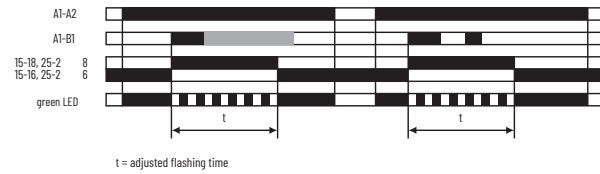
(F) Flasher [Repeat Cycle Starting with Pulse]



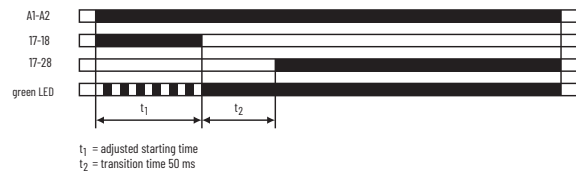
(E) Fleeting Off-delay [Impulse Off]



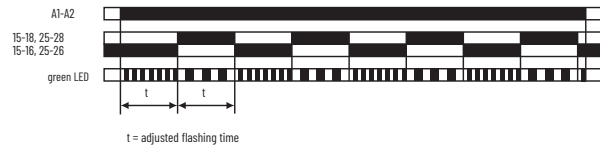
(L) Pulse Converter [Pulse Former]



(Y) Star-Delta Timing Relay




(G) Flasher [Repeat Cycle Starting with Pause]



Specifications^(a)

Table 88 - 700-FE Ratings

Attribute		700-FE	
Contacts			
Setting Accuracy		±10% of full scale	
Repeatability		±0.5% of setting (typical)	
Tolerance		By voltage: ±0.001%/ΔU By temperature: ±0.025%/°C	
Supply			
Supply Voltage		24...48V DC and 24...240V AC, 50/60 Hz	
Voltage Tolerance	AC	-15%/+10%	
	DC	-15%/+10%	
Power Consumption		Max 3.5VA	
Time Energized		100%	
Reset Time		50 ms	
Cable Length (Supply Voltage Control)		Max 50 m (164 ft)	
Pulse Control (B1)			
Impulse Duration		20 ms	
Input Voltage		supply voltage range	
Input Current		1 mA	
Outputs			
Contact Type		1 Form C – SPDT contact	
Dielectric Withstand Voltage	Contact-to-coil	4000V	
	Power	3600VA (Make) 360VA (Break)	
Switching Capacity	According to IEC 947-5-1	AC-12	4 A /230V AC (resistive load)
		AC-15	0.2 A/230V AC (inductive load)
		DC-13	1 A/24V DC (inductive load)
According to UL 508		NEMA B300 - 5 A/300V AC	
Short circuit Resistance		N/C 6 A, N.O. 10 A (Fast Blow Fuse)	
Life	Mechanical	30 million operations	
	Electrical	Min 100,000 operations	
Insulation Characteristics		2 kV AC/50 Hz test voltage according to VDE 0435 and 4 kV 1.2/50 μs surge voltage according to IEC 60947-1 between all inputs and outputs	
EMC/Interference Immunity		The following requirements are fulfilled: Surge capacity of the supply voltage according to IEC 61000-4-5: Level 4 Burst according to IEC 61000-4-4: Level 3 ESD discharge according to IEC 61000-4-2: Level 3	
EMC / Emission		Electromagnetic fields according to EN 55 022: Class B	
Climatic Class		3K3 according to IEC 60068-2-30	
Vibration Resistance, operating		1 G	
Vibration Resistance, non-operating		4 G	
Shock Resistance, operating		7 G	
Shock Resistance, non-operating		50G	
Protection Class IEC 60947-1		Terminal: IP 20	
Relative Humidity		25...85%	
Ambient Temperature	Operation	-20...+60 °C (4...140)	
	Storage	-40...+85 °C (-40...+185 °F)	
Weight		60 g (2.1 oz)	

(a) Time Characteristics (according to VDE 0435, part 2021)

Table 88 - 700-FE Ratings (Continued)

Attribute	700-FE
Connections	Screw terminal M3 for Pozidriv No.1, Phillips, and slotted screws No.2. suitable for power screwdriver. Rated tightening torque 8.8 lb-in (max 1.0 N•m) For terminal cross-sections of 1 x 0.5 mm ² ...2 x 1.5 mm ² (solid) or 2 x 1.5 mm ² (stranded with sleeve), #20...14 AWG. Finger protection according to EN 50274
Mounting	For surface mounting in any position; snap-on mounting on 35 mm DIN Rail
Disposal	Synthetic materials without dioxin according to EC/EFTA-Notification No. 93/0141/D

Table 89 - Standards Compliance and Certifications

Attribute	700-HT3 Timing Module
Certifications	<ul style="list-style-type: none"> • cULus Listed (File No. E14840, Guide NKCR/NKCR7) • CE Marked • Germanischer Lloyd
Standards Compliance	<ul style="list-style-type: none"> • UL508 • CSA C22.2 No. 14 • EN/IEC 60947-1 • EN/IEC 60947-5-1

IMPORTANT For best long-term performance, allow at least 10 mm (0.04 in.) of space on each side of the relay for proper ventilation when operating in temperatures above 40 °C (104 °F).

Approximate Dimensions

Approximate dimensions are shown in millimeters (inches). Dimensions are not intended for manufacturing purposes.

Figure 74 - Cat. No. 700-FE with 1 C/O Contact or 2 N.O. Contacts

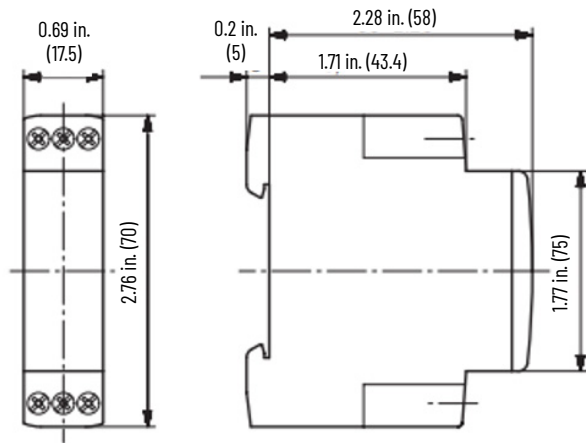
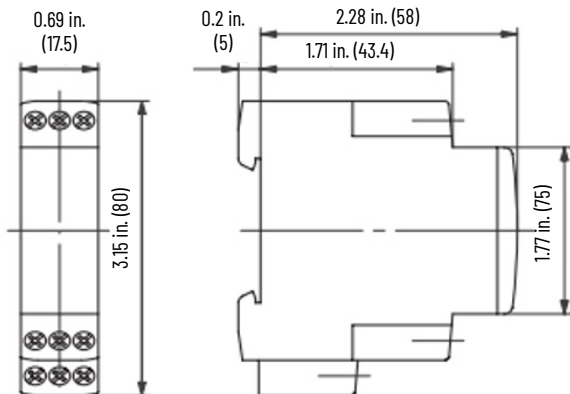


Figure 75 - Cat. No. 700-FE with 2 C/O Contacts



700-FS High-Performance Timing Relay



- Adjustable function and timing range timing relays
 - Timing Ranges From 0.05 s...300 h
- DIN Rail mounted without cost of socket
- 22.5 mm wide multi-function or single functions
- Available as SPDT or DPDT contact output, 5 A
- Coil surge protection
- Hazardous location version available

Product Selection

Function Type	Operating Mode	Contact Output	Timing Range	Input Voltage	Cat. No.
Single Function • With DPDT 2 C/O contacts	ON-delay	SPDT (1 C/O)	0.05 s...300 h (7 settings) ⁽¹⁾	24V...48V DC 24...240V AC, 50/60 Hz	700-FSA6UU23
		DPDT (2 C/O)			700-FSA7UU23
	OFF-delay	SPDT (1 C/O)			700-FSB6UU23
		DPDT (2 C/O)			700-FSB7UU23
	One-Shot w/B1	SPDT (1 C/O)			700-FSK6UU23
Single Function with Hazardous Location Certification • With SPDT 1 C/O contacts	One-Shot w/B1	SPDT (1 C/O)	0.05 s...300 h (7 settings) ⁽¹⁾	24V...48V DC 24...240V AC, 50/60 Hz	700-FSK6UU23-EX
Multi-function • See function diagrams for further description.	• 10 Single-functions: - A, A+, B, C, T, D, E, FG, L, and Y1	SPDT (1 C/O)	0.05 s...300 h (7 settings) ⁽¹⁾	24V...48V DC 24...240V AC, 50/60 Hz	700-FSM6UU23
		(DPDT) 2 C/O			700-FSM7UU23
	7 Single-functions: - A, T, D, I, M, F, and G	(DPDT) 2 C/O		380...440V AC	700-FSM7UA40
				24V...48V DC 24...240V AC, 50/60 Hz	700-FSM8UU23
Multi-function with Hazardous Location Certification • See function diagrams for further description.	• 10 Single-functions: A, A+, B, C, T, D, E, FG, L, and Y1	SPDT (1 C/O)	0.05 s...100 h ⁽²⁾	24V...48V DC 24...240V AC, 50/60 Hz	700-FSM6UU23-EX
		(DPDT) 2 C/O	0.05 s...300 h (7 settings) ⁽¹⁾		700-FSM7UU23-EX
	7 Single-functions: - A, T, D, I, M, F, and G	(DPDT) 2 C/O	0.05 s...300 h (7 settings) ⁽¹⁾		700-FSM8UU23-EX
Special Function	OFF-delay without auxiliary voltages	SPDT (1 C/O)	0.05 s...10 min ⁽³⁾	24V...240V DC 24...240V AC, 50/60 Hz	700-FS06QU18
		(DPDT) 2 C/O			700-FS07QU18
	Star-Delta	2 C/O		24...48V DC 380...440V AC	700-FS07QU23 700-FS07UA40

(1) Ten selectable timing ranges: 0.05...1 s, 0.15...3 s, 0.5...10 s, 1.5...30 s, 5...100 s, 15...300 s, 1.5...30 min, 15...300 min, 1.5...30 h, 15...300 h.

(2) Time ranges: 0.05...1 s, 0.5...10 s, 5...100 s, 0.5...10 min, 5...100 min, 0.5...10 h, 5...100 h.

(3) This time range is selectable in seven smaller ranges: 0.05 s...1 s, 0.15...3 s, 0.15 s...10 s, 1.5 s...30 s, 5...100 s, 15...300 s, 0.5...10 min.

IMPORTANT

- Temp. Code T4A 2 A 32V DC MAX: II 3 G, EEx nL IIC T4 DEMKO 04 ATEX 0404974X 2 A 32V DC MAX T_a 70 °C (158 °F)
 - Ind. Cont. Eq. for Hazardous Location Listed 87SL Class 1, Div. 2, Groups A,B,C,D Class 1, Zn 2, Group IIC
- Subject devices are to be installed in an ATEX Certified IP54 (as defined in IEC 60529) enclosure and accessible only by the use of a tool.

Accessories

700-FS Accessories

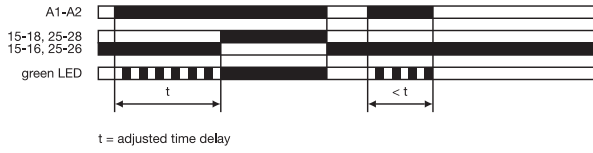
Description	Pkg. Qty.	Cat. No.
Panel Mounting Adapter • For surface mounting according to drilling plan EN 50 002	5	700-FSPMA
Transparent Cover	10	100-FSTC

IMPORTANT

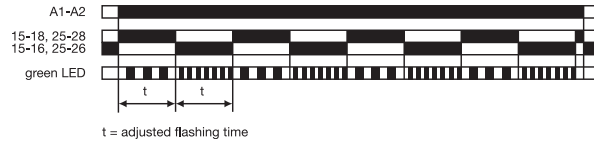
Versatile Mounting: The 700-FS timing relay can be panel or DIN rail mounted. For best long-term performance, allow at least 10 mm (0.04 in.) of space on each side of the relay for proper ventilation when operating in temperatures above 40 °C (104 °F).

Function Diagrams

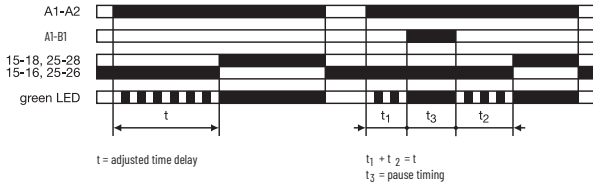
(A) On-delay



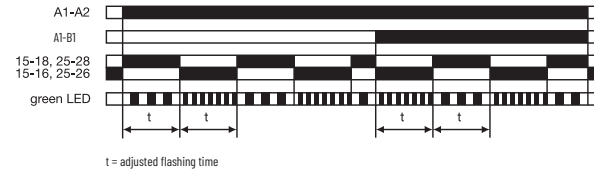
(F) Flasher, Starting with ON



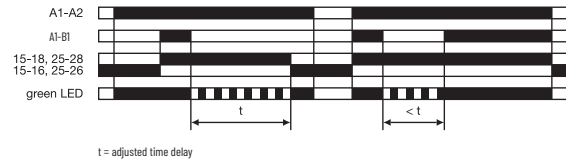
(A+) Accumulative ON-delay



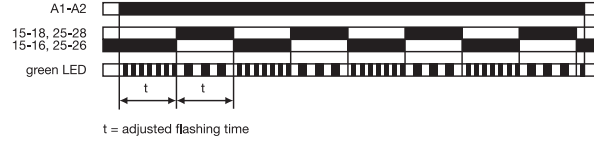
(FG) Flasher, Starting with ON or OFF



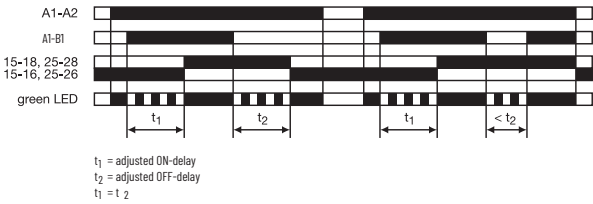
(B) OFF-delay with Auxiliary Voltage



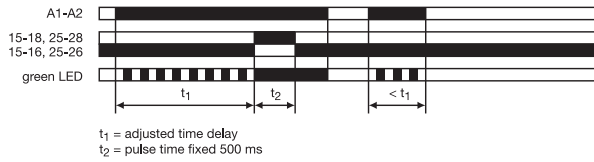
(G) Flasher, Starting with OFF



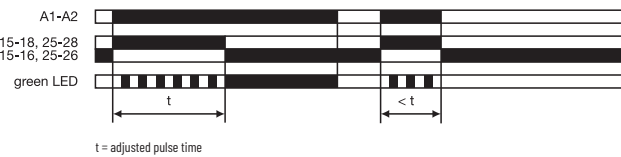
(C) ON-delay and OFF-delay, Symmetrical



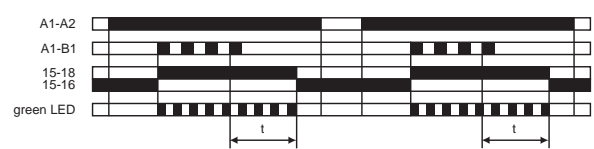
(I) Fixed Impulse with Adjustable Time Delay



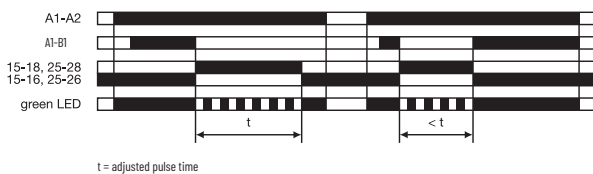
(D) Impulse-ON



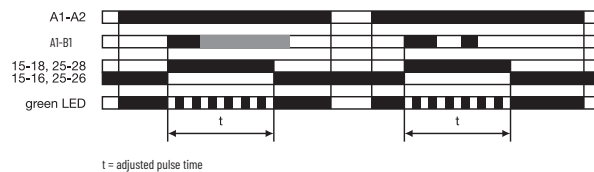
(K) One Shot with B1



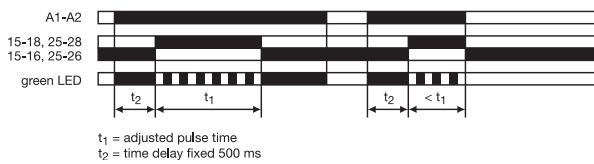
(E) Impulse-OFF with Auxiliary Voltage



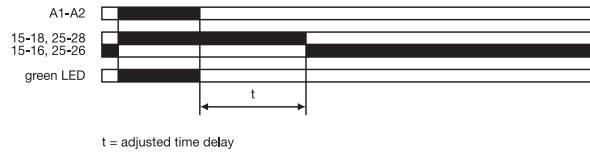
(L) Pulse Former



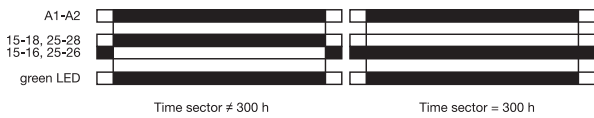
(M) Adjustable Impulse with Fixed Time Delay



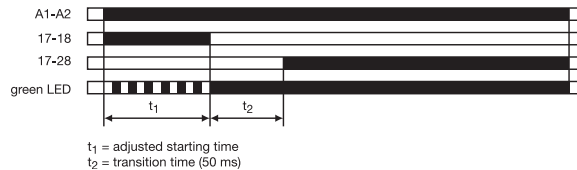
(Q) OFF-delay without Auxiliary Voltage



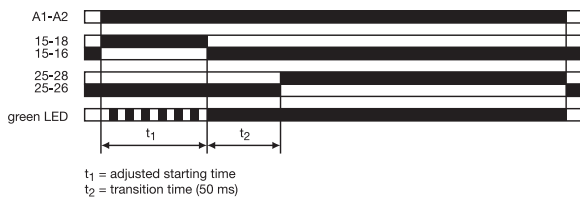
(T) ON/OFF-function



(Y) Star-delta Change-over



(Y1) Star-delta Change-over with Impulse Function



Specifications^(a)

Table 90 - General Ratings

Attribute	Value
Setting Accuracy	$\pm 6\%$ of full scale
Repeatability	$\pm 0.2\%$ of the setting values
Tolerance	Voltage: $\pm 0.004\%/V$ Temperature: $\pm 0.035\%/^{\circ}C$

Table 91 - Supply

Attribute	Value
Supply Voltages	24...48V DC and 24...240V AC, 50/60 Hz (multi voltage)
Voltage Tolerance	-15...+10% (-25...+10% DC-EX)
Power Consumption	Max 16VA
Time Energized	100%
Reset Time	<80 ms
Cable Length (Supply Voltage Control)	50 m (800 ft) - 100 pF/m

Table 92 - Pulse Control (B1)

Attribute	Value
Pulse Duration	≥ 20 ms
Input Voltage	Supply voltage range
Input Current	1 mA
Cable Length	50 m (800 ft) - 100 pF/m

Table 93 - Outputs

Attribute	Value
Contact Type	Relay as changeover switch
Dielectric Coil to Contact Withstand Voltage	4000V
	Voltage: 500V AC
Switching Capacity	According to IEC 947-5-1:
	3 A/230V AC (inductive load, AC 15)
	2 A/24V DC (inductive load, DC 13)
	According to UL 508:
	1.5 A/250V AC (B300)
	3 A/120V AC (B300)
Life	Mechanical: 30 million operations
	Electrical: 100,000 operations at AC12, 230V, 4 A
State Indicator	1 LED, combination signal

(a) Time Characteristics (according to VDE 0435, Part 2021)

Table 94 - General Data

Insulation Characteristics	2 kV AC/50 Hz test voltage according to VDE 0435 and 4 kV 1.2/50 μ s surge voltage according to IEC 947-1 between all inputs and outputs
EMC/Interference Immunity	Performance of the following requirements: Surge capacity of the supply voltage according to IEC 61000-4-5: 2 kV Burst according to IEC 1000-4-4: 6 kV 6/50 ns ESD discharge according to IEC 61000-4-2: Contact 6 kV, air 8 kV
EMC/Emission	Electromagnetic fields according to EN 55 022: class B
Safe Isolation	According to VDE 106, part 101
Relative Humidity	25... 85%
Vibration Resistance, operating	1 G
Vibration Resistance, nonoperating	4 G
Shock Resistance, operating	7 G
Shock Resistance, nonoperating	50 G
Ambient Temperature, operating	-25...+60 °C
Ambient Temperature, nonoperating	-40...+85 °C
Terminals	Tightening torque 5.31...7.08 lb•in (0.6...0.8 N•m) 1 x 0.5...2.5 mm ² (stranded) / 1 x 0.5...4 mm ² , 2 x 0.5...2.5 mm ² (solid)
Mounting	Front mounting; For snap-on mounting on 35 mm DIN Rail or screw fixing by adapter and 2 screws (M4 type)
Weight	100 g (3.5 oz)
Certifications	cULus Listed (File No. E14840, Guide NKCR/NKCR7), CE Marked
Standards Compliance	EN/IEC 60947-1, EN/IEC 60947-5-1, UL 508, CSA 22.2 No. 14



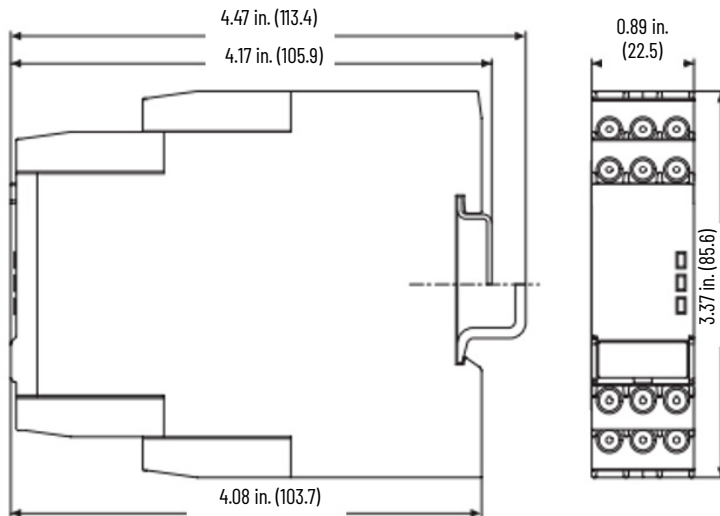
Temp. Code T4A
2 A 32V DC max

Mounting: Install the product in an enclosure constructed in accordance with the requirements of EN50021.

Approximate Dimensions

Approximate dimensions are shown in millimeters (inches). Dimensions are not intended for manufacturing purposes.

Figure 76 - Cat. No. 700-FS



700-HNC Miniature Timing Relay







- Miniature timer, perfect for converting 700-HC "Ice Cube" relays into timing relays
- Four operating modes
- 4PDT contact output
- Timing range from 0.1 s...10 h
- Socket mounted

Product Selection

Timing Mode	Contact Output	Input Voltages	Timing Range	Socket Type	Cat. No.
On-delay One Shot Repeat cycle, OFF-start Repeat cycle, ON-start	4PDT	12V DC	0.1 s...10 min	700-HN103 700-HN128	700-HNC44AZ12
			0.1 min...10 h		700-HNC44BZ12
		24V DC	0.1 s...10 min		700-HNC44AZ24
			0.1 min...10 h		700-HNC44BZ24
		48V DC	0.1 s...10 min		700-HNC44AZ48
			0.1 min...10 h		700-HNC44BZ48
		100...110V DC	0.1 s...10 min		700-HNC44AZ11
			0.1 min...10 h		700-HNC44BZ11
		125V DC	0.1 s...10 min		700-HNC44AZ25
			0.1 min...10 h		700-HNC44BZ25
		24V AC	0.1 s...10 min		700-HNC44AA24
			0.1 min...10 h		700-HNC44BA24
		100...120V AC	0.1 s...10 min		700-HNC44AA12
			0.1 min...10 h		700-HNC44BA12
		200...230V AC	0.1 s...10 min		700-HNC44AA23
			0.1 min...10 h		700-HNC44BA23

Accessories

Sockets and DIN Rail

	Description	For Use With	Pkg. Qty.	Cat. No.	
	<ul style="list-style-type: none"> • Guarded Terminal Construction 	700-HNC Relays	10	700-HN103	
	Screw Terminal Socket <ul style="list-style-type: none"> • Panel or DIN Rail Mounting • $I_{th} = 10$ A per pole • 14-blade miniature socket 	<ul style="list-style-type: none"> • Guarded Terminal Construction • Coil and contact separation • Can be used with optional plug-in modules (700-A__ accessories, LED, surge suppression, timing modules) 	700-HNC Relays	10	700-HN104
	<ul style="list-style-type: none"> • Open-Style Construction 	700-HNC Relays	10	700-HN128	
	Retainer Clip <ul style="list-style-type: none"> • Secures relay in socket • Order must be for 10 clips or multiples of 10. 	Cat. Nos. 700-HN103, -HN104 Sockets with 700-HNC Relays	10	700-HN263	

Specifications

Table 95 - General Ratings

Attribute		700-HNC	
Pilot Duty Rating		NEMA B300	
Pin type		Plug-in	
Operating voltage range		85%...110% of rated supply voltage (12V DC: 90%...110% of rated supply voltage) ⁽¹⁾	
Reset voltage		10% min of rated supply voltage	
Power consumption	24V AC:	Relay ON: Relay OFF:	1.5VA (1.1 W) (at 24V AC, 60 Hz) 0.2VA (0.1 W) (at 24V AC, 60 Hz)
	100...120V AC:	Relay ON: Relay OFF:	1.50.2VA (1.3 W) (at 120V AC, 60 Hz) 0.8VA (0.5 W) (at 120V AC, 60 Hz)
	200...230V AC:	Relay ON: Relay OFF:	1.8VA (1.5 W) (at 230V AC, 60 Hz) 1.2VA (0.9 W) (at 230V AC, 60 Hz)
	12V DC:	Relay ON: Relay OFF:	0.9 W (at 12V DC) 0.07 W (at 12V DC)
	24V DC:	Relay ON: Relay OFF:	0.9 W (at 24V DC) 0.07 W (at 24V DC)
	48V DC:	Relay ON: Relay OFF:	1.0 W (at 48V DC) 0.2 W (at 48V DC)
	100...110V DC:	Relay ON: Relay OFF:	1.3 W (at 110V DC) 0.3 W (at 110V DC)
	125V DC:	Relay ON: Relay OFF:	1.3 W (at 125V DC) 0.3 W (at 125V DC)
Control outputs		4PDT: 5 A at 250V AC, resistive load (cos φ = 1)	
Characteristics			
Make ▶ ◀	120V AC	30 A	
	240V AC	15 A	
Break ◀ ▶	120V AC	3 A	
	240V AC	1.5 A	
Hp at 120V AC		1/6 Hp	
Hp at 240V AC		1/6 Hp	
Accuracy of operating time		±1% FS max (1 s range: ±1%±10 ms max)	
Setting error		±10%±50 ms FS max	
Reset time		Min power-opening time: 0.1 s max (including halfway reset)	
Influence of voltage		±2% FS max	
Influence of temperature		±2% FS max	
Insulation resistance		100 mΩ min (at 500V DC)	
Dielectric strength	2000V AC, 50/60 Hz for 1 min (between current-carrying terminals and exposed non-current-carrying metal parts) ⁽²⁾		
	2000V AC, 50/60 Hz for 1 min (between operating power circuit and control output)		
	2000V AC, 50/60 Hz for 1 min (between different pole contacts; 2-pole model)		
	1500V AC, 50/60 Hz for 1 min (between different pole contacts; 4-pole model)		
	1000V AC, 50/60 Hz for 1 min (between non-continuous contacts)		
Vibration resistance		Malfunction: 10...55 Hz, 0.5 mm single amplitude	
Shock resistance		Malfunction: 100 m/s ² (approx. 10G)	
Ambient temperature	Operating	-10...+50 °C (14...104 °F) (with no icing)	
	Storage	-25...+65 °C (-13...+149 °F) (with no icing)	
Ambient humidity	Operating	35...85%	
Life expectancy	Mechanical	Mechanical: 10 000 000 operations min (under no load at 1800 operations/h)	
	Electrical	Electrical: 4PDT: 200 000 operations min (3 A at 250V AC, resistive load at 1800 operations/h)	
Noise immunity		±1.5 kV, square-wave noise by noise simulator (pulse width: 100 ns / 1 μs, 1- ns rise)	
Static immunity		Destruction: 8 kV Malfunction: 4 kV	
Enclosure rating		IP40	
Weight		Approx. 50 g (1.76 oz)	

Table 95 - General Ratings (Continued)

Attribute	700-HNC
EMC	Emission Enclosure: EN55011 Group 1 class A
	Emission AC Mains: EN55011 Group 1 class A
	Immunity ESD: EN61000-4-2: 4 kV contact discharge (level 2) 8 kV air discharge (level 3)
	Immunity RF-interference: EN50140: 10 V/m (amplitude modulated, 80 MHz to 1 GHz) (level 3) 10V/m (pulse modulated, 900 MHz)
	Immunity Conducted Disturbance: EN50141: 10 V (0.15...80 MHz) (level 3)
Standards	UL 508, CSA 22.2 No. 14, EN/IEC 61812-1
Certifications	cURus Recognized (File No. E14843, Guide NRNT2/NRNT8), CSA Certified (File 224268), CE Marked, C-Tick Marked

- (1) Single-phase, full-wave-rectified power supplies can be used.
- (2) When using the 700-HNC continuously in any place where the ambient temperature is in a range of 45...50 °C (113...122 °F), supply 90%...110% of the rated supply voltages supply 95%...110% with 12V DC type).

Figure 77 - General Timer Functions

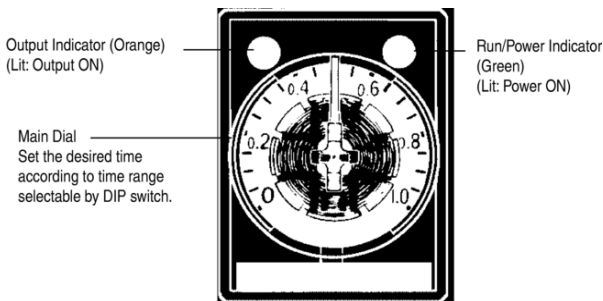
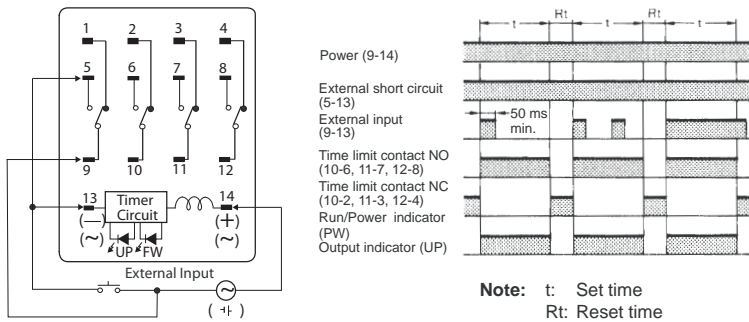


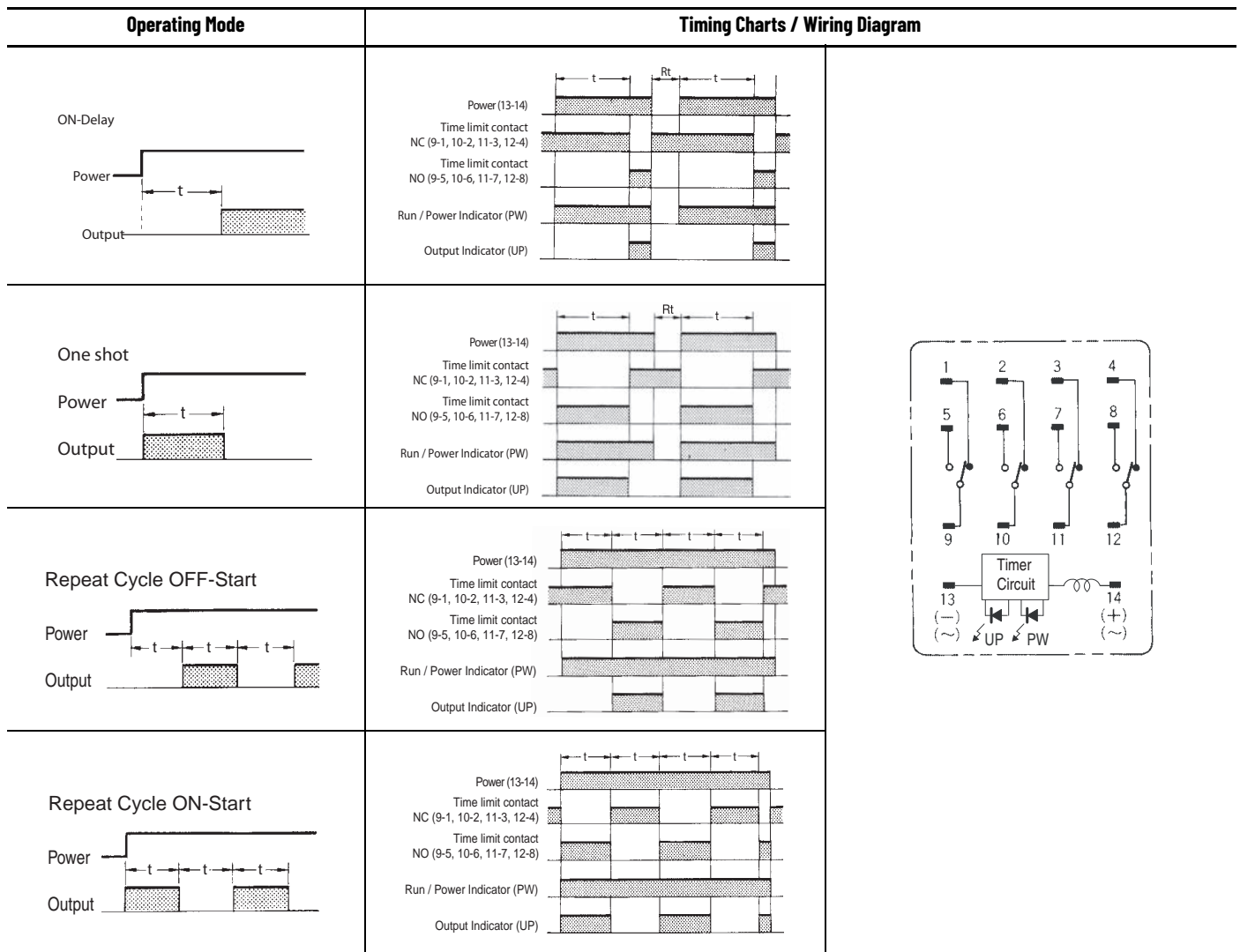
Figure 78 - Pulse Operation



A pulse output for a certain period can be obtained with a random external input signal. Use the 700-HNC timing relay in interval mode as shown in the following timing charts.









Timing Charts

t: Set time, Rt: reset time



DIP Switch Settings

Table 96 - Time Ranges

Cat. No.	Time Range	Time Setting Range	Setting	Factory-Set
700-HNC44AZ12 700-HNC44AZ24	1 s	0.1 s...1 s		Yes
700-HNC44AZ48 700-HNC44AZ11 700-HNC44AZ25	10 s	1 s...10 s		No
700-HNC44AA24 700-HNC44AA12 700-HNC44AA23	1 min	0.1 s...1 min		No
	10 min	1...10 min		No
700-HNC44BZ12 700-HNC44BZ24	1 min	0.1...1 min		Yes
700-HNC44BZ48 700-HNC44BZ11 700-HNC44BZ25	10 min	1...10 min		No
700-HNC44BA24 700-HNC44BA12	1 h	0.1...1 h		No
700-HNC44BA23	1 h	1...10 h		No



The top two DIP switch pins are used to select the time ranges.

Figure 79 - DIP Switch pins

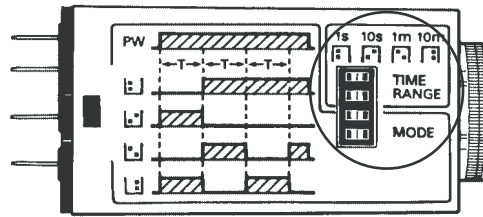


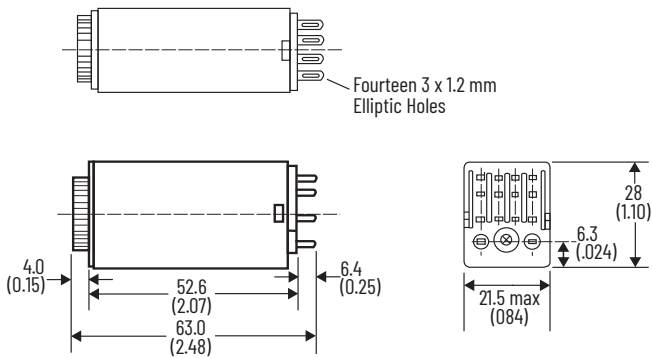
Table 97 - DIP Switch selection for Operating Modes

Operating Mode	Setting	Factory-set
ON-delay		Yes
One Shot		No
Repeat Cycle OFF-start		No
Repeat Cycle ON-start		No

Approximate Dimensions

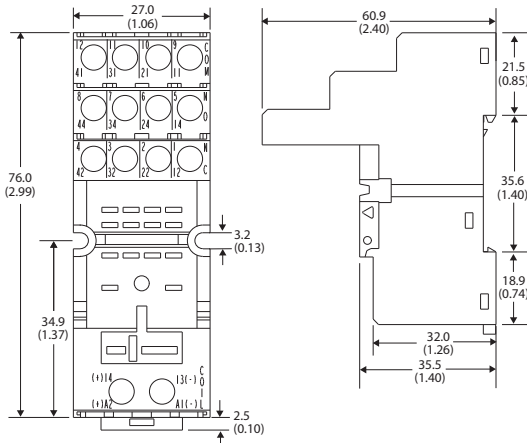
Approximate dimensions are shown in millimeters (inches). Dimensions are not intended for manufacturing purposes.

Figure 80 - Cat. No. 700-HNC



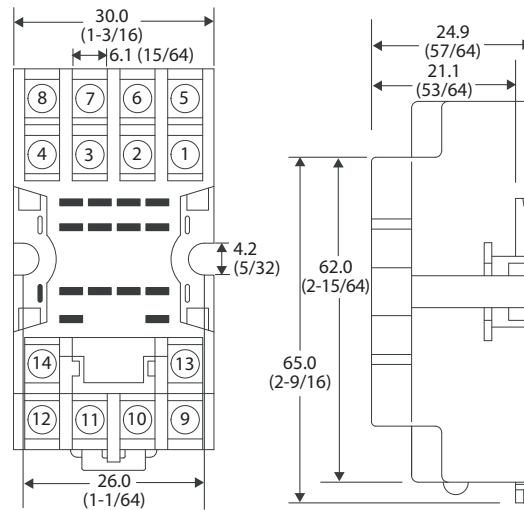
Sockets

Figure 81 - Cat. No. 700-HN104



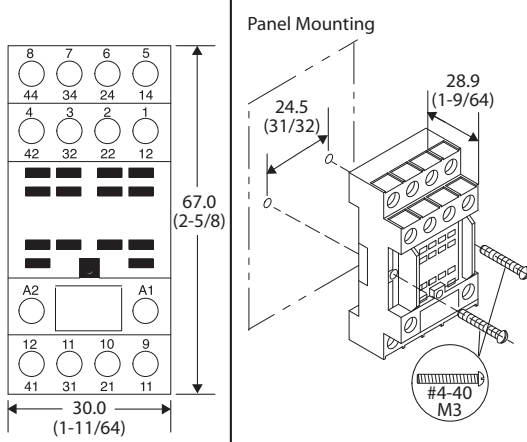
Wire Type: solid or stranded, Cu only
 Single Wire - 0.2...2.5 mm² (#24...14 AWG)
 Double Wire - 2 x 0.2...2.5 mm² (#24...14 AWG) (Either Solid or Stranded)
 Strip Length: 7 mm (9/32 in.) - Torque: 0.5 N•m (4.4 lb•in)

Figure 83 - Cat. No. 700-HN128



Wire Size: 2 x 1.5 mm² (#2-16 AWG...#1-20 AWG)
 (Either Solid or Stranded)
 Strip Length: 9 mm (3/8 in.) - Torque: 0.8 N•m (7 lb•in)
 Total height of 700-HN128 + 700-HNC is 82.5 mm.

Figure 82 - Cat. No. 700-HN103



Wire Size - 2 x 1.5 mm² (#24...14 AWG)
 Double Wire - 2 x 0.2...2.5 mm² (#2...16...#1...20 AWG) (Either Solid or Stranded)
 Strip Length: 9 mm (3/8 in.) - Torque: 0.8 N•m (7 lb•in)

700-HNK Ultra-Slim Timing Relay

- The ultra-slim timing relay is the smallest relay available
- It is perfect for converting 700-HK relays into a timing relay
- SPDT and DPST-N.O. contact output
- Socket-mounted
- Timing range From 0.1 s...10 h



Product Selection

Photo	Timing Mode	Socket Type	Contact Output	Timing Range	Input Voltage	Cat. No.
	On-delay One Shot Repeat Cycle, OFF-start Repeat Cycle, ON-start	700-HN121	SPDT ⁽¹⁾	0.1 s...10 min	12V DC	700-HNK41AZ12
					24V DC	700-HNK41AZ24
					24V AC	700-HNK41AA24
				0.1 min...10 h	12V DC	700-HNK41BZ12
					24V DC	700-HNK41BZ24
					24V AC	700-HNK41BA24
		700-HN122	DPST-NO ⁽²⁾	0.1 s...10 min	12V DC	700-HNK42AZ12
					24V DC	700-HNK42AZ24
					24V AC	700-HNK42AA24
				0.1 min...10 h	12V DC	700-HNK42BZ12
					24V DC	700-HNK42BZ24
					24V AC	700-HNK42BA24

(1) 5-blade terminal type only.

(2) 8-blade terminal type only.

Accessories

Sockets and Adapters

	Description	For Use With	Pkg. Qty.	Cat. No.	
	Screw Terminal Socket <ul style="list-style-type: none"> • Panel or DIN Rail Mounting • 5-blade miniature socket 	<ul style="list-style-type: none"> • 10 A rating • Accepts forked lug conductors • Includes retainer clip 	1-pole 700-HK relays	10	700-HN121
	Screw Terminal Socket <ul style="list-style-type: none"> • Panel or DIN Rail Mounting • 8-blade miniature socket 	<ul style="list-style-type: none"> • 5 A rating • Accepts forked lug conductors • Includes retainer clip 	2-pole 700-HK relays	10	700-HN122

Specifications

Table 98 - General Ratings

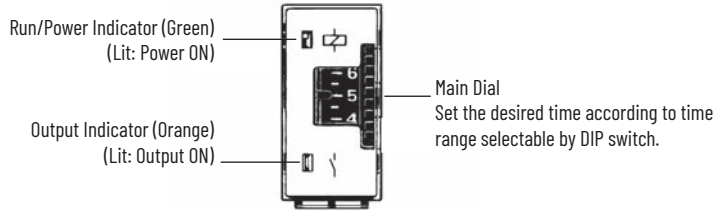
Attribute		700-HNK
Pilot Duty Rating		NEMA B300
Rated Supply Voltage		24V AC; 12, 24V DC
Pin Type		Plug-in
Operating Mode		ON-delay, One Shot, Repeat Cycle OFF start, or Repeat Cycle ON start selectable with DIP switch.
Operating Voltage Range		85%...110% of rated supply voltage (12V DC: 90%...110% of rated supply voltage) ⁽¹⁾
Power Consumption		24V AC: Relay ON: approx. 0.81.2VA (at 24 VAC, 60 Hz) Relay OFF: 0.5 VA (at 24V AC, 60 Hz) 12V DC: Relay ON: approx. 0.4 W (at 12V DC) Relay OFF: 0.1 W (at 12V DC) 24V DC: Relay ON: approx. 0.5 W (at 24V DC) Relay OFF: 0.2 W (at 24V DC)
Control Outputs		5 A at 250V AC, resistive load (cos φ = 1) The minimum applicable load is 10 mA at 5V DC (P reference value).
Characteristics		
Make ▶ ◀	120V AC	30 A
	240V AC	15 A
Break ◀ ▶	120V AC	3 A
	240V AC	1.5 A
Hp at 240V AC		1/6 Hp
Accuracy of Operating Time		±1% FS max (1 s range: +1% ±10 ms max)
Setting Error		±15% +50 ms FS max
Reset Time		Min power-opening time: 12, 24V DC: 0.1 s max (including halfway reset) 24V AC: 0.5 s max (including halfway reset)
Influence of Voltage		±2% FS max
Influence of Temperature		±2% FS max
Insulation Resistance		100 mΩ min (at 500V DC)
Dielectric Strength		2000V AC, 50/60 Hz for 1 min (between operating circuit and control output, or contacts of different poles) 1000V AC, 50/60 Hz for 1 min (between non-continuous contacts)
Vibration Resistance		Malfunction: 10...55 Hz, 0.5 mm single amplitude
Shock Resistance		Malfunction: 100 m/s ² (approx. 10G)
Ambient Temperature	Operating	-10...+50 °C (14...104 °F) (with no icing)
	Storage	-25...+65 °C (-13...+149 °F) (with no icing)
Ambient Humidity		Operating: 35...85%
Life Expectancy		Mechanical: 10 000 000 operations min (under no load at 1800 operations/h) Electrical: 100 000 operations min (3 A at 250V AC, resistive load at 1800 operations/h)
Impulse Withstand Voltage		Between power terminals: 1 kV
Noise Immunity		±1.5 kV, square-wave noise by noise simulator (pulse width: 100 ns/1 μs, 1-ns rise)
Static Immunity		Destruction: 8 kV Malfunction: 4 kV
Enclosure Rating		IP20
Weight		Approx. 18 g
EMC		Emission Enclosure: EN55011 Group 1 class A Emission AC Mains: EN55011 Group 1 class A Immunity ESD: EN61000-4-2:4 kV contact discharge (level 2) 8 kV air discharge (level 3) Immunity RF-interference: ENV50140: 10V/m (amplitude modulated, 80 MHz...1GHz) (level 3) 10 V/m (pulse modulated, 900 MHz) Immunity Conducted Disturbance: ENV50141:10 V (0.15...80 MHz) (level 3) Immunity Burst: EN61000-4-4:2 kV power-line (level 3) 2 kV I/O signal-line (level 4)
Standards		UL508, CSA C22.2 No. 14, EN/IEC 60947-5-1, EN/IEC 61812-1
Certifications		cURus Recognized Component (File No. E14843, Guide NRNTZ/NRNT8), CE Marked, C-Tick Marked

(1) When using 700-HNK timer in any place where the ambient temperature is more than 50 °C, supply 90...110% of the rated voltages (12V DC: 95...11% of the rated voltage).

General Timer Functions



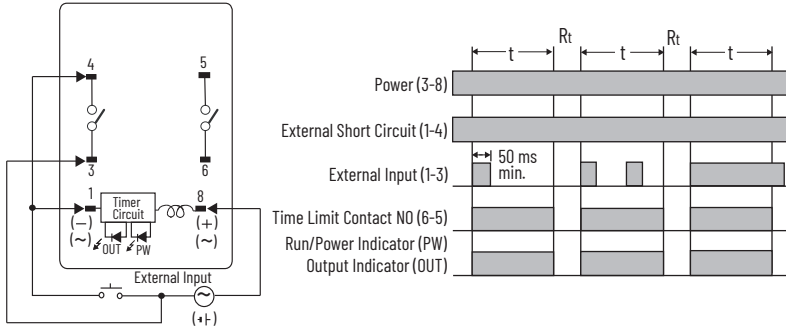
t: Set time, Rt: reset time



Operating Mode	Timing Charts/Wiring Diagram	
	700-HNK41...	700-HNK42...
<p>ON-Delay</p>	<p>Power(1-5)</p> <p>Time limit contact NC(4-2)</p> <p>Time limit contact NO(4-3)</p> <p>Run/ Power Indicator (PW)</p> <p>Output Indicator (OUT)</p>	<p>Power(1-8)</p> <p>Time limit contact NO(4-3, 5-6)</p> <p>Run/ Power indicator (PW)</p> <p>Output indicator (OUT)</p>
<p>One shot</p>	<p>Power(1-5)</p> <p>Time limit contact NC(4-2)</p> <p>Time limit contact NO(4-3)</p> <p>Run/ Power Indicator (PW)</p> <p>Output Indicator (OUT)</p>	<p>Power(1-8)</p> <p>Time limit contact NO(4-3, 5-6)</p> <p>Run/ Power indicator (PW)</p> <p>Output indicator (OUT)</p>
<p>Repeat Cycle OFF-Start</p>	<p>Power(1-5)</p> <p>Time limit contact NC(4-2)</p> <p>Time limit contact NO(4-3)</p> <p>Run/ Power Indicator (PW)</p> <p>Output Indicator (OUT)</p>	<p>Power(1-8)</p> <p>Time limit contact NO(4-3, 5-6)</p> <p>Run/ Power indicator (PW)</p> <p>Output indicator (OUT)</p>
<p>Repeat Cycle ON-Start</p>	<p>Power(1-5)</p> <p>Time limit contact NC(4-2)</p> <p>Time limit contact NO(4-3)</p> <p>Run/ Power Indicator (PW)</p> <p>Output Indicator (OUT)</p>	<p>Power(1-8)</p> <p>Time limit contact NO(4-3, 5-6)</p> <p>Run/ Power indicator (PW)</p> <p>Output indicator (OUT)</p>

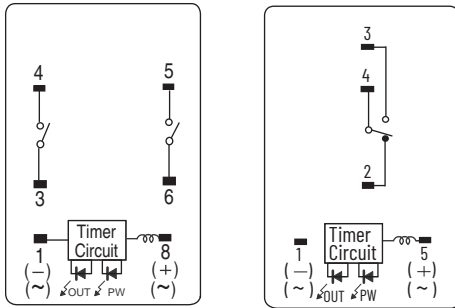
Wiring Diagrams

Figure 84 - Pulse Operation



A pulse output for a certain period can be obtained with a random external input signal. Use the 700-HNK timing relay in interval mode as shown in the timing chart.

Figure 85 - Wiring



Cat. No. 700-HNK42...

Cat. No. 700-HNK41...

Mode	Terminals
Pulse Operation	Power supply between 3 and 8 Short-circuit between 4 and 1 Input signal between 3 and 1
Operating mode; One shot and all other modes	Power supply between 1 and 8

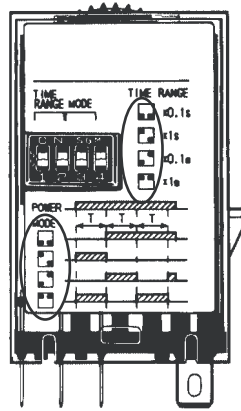
Time Ranges- 700-HNK Relays



The left two DIP switch pins are used to select the time ranges.

Cat. No.	Time Range	Time Setting Range	Setting	Factory-Set
700-HNK41AZ12 700-HNK41AZ24 700-HNK41AA24 700-HNK42AZ12 700-HNK42AZ24 700-HNK42AA24	1 s	0.1...1 s		Yes
	10 s	1...10 s		No
	1 min	0.1 s...1 min		No
	10 min	1...10 min		No
700-HNK41BZ12 700-HNK41BZ24 700-HNK41BA24 700-HNK42BZ12 700-HNK42BZ24 700-HNK42BA24	1 min	0.1...1 min		Yes
	10 min	1...10 min		No
	1 h	0.1...1 h		No
	10 h	1...10 h		No

Operating Modes



Operating Mode	Setting	Factory-set
On-delay		Yes
One Shot		No
Repeat Cycle Off-start		No
Repeat Cycle On-start		No



The right two DIP switch pins are used to select the operating modes.

Approximate Dimensions

Approximate dimensions are shown in millimeters (inches). Dimensions are not intended for manufacturing purposes.

Figure 86 - 700-HNK41 SPDT Contact

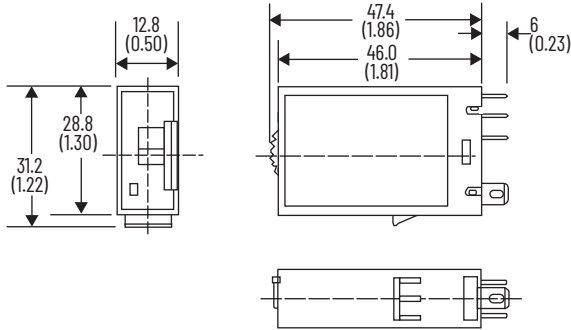
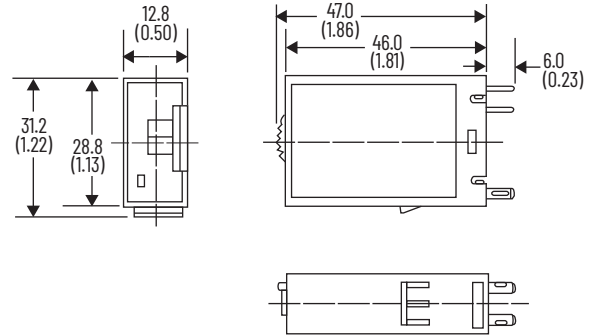


Figure 87 - 700-HNK42 DPST-N.O. Contact

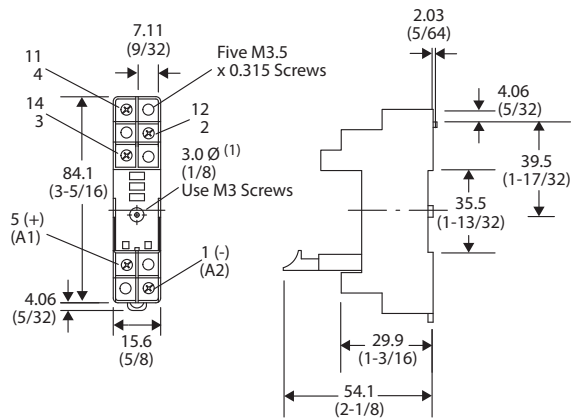


Sockets



Holes required for mounting [3 mm (1/8 in.) diameter].

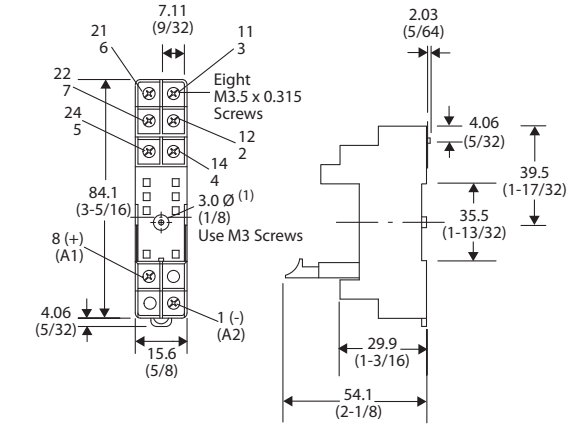
Figure 88 - Cat No. 700-HN121



Wire Size: 2 x 2.5 mm²
Single Wire - Up to #12 AWG

Double Wire - 2 x 2.5 mm² (#2-14 AWG... #2-20 AWG) (Either Solid or Stranded)
Strip Length: 9 mm (3/8 in.) - Torque: 0.8 N•m (7 lb•in)
Total height: 700-HN121 + 700-HNK41 is 78.0 mm.

Figure 89 - Cat No. 700-HN122



Wire Size: 2 x 2.5 mm²
Single Wire - Up to #12 AWG

Double Wire - 2 x 2.5 mm² (#2-14 AWG... #2-20 AWG) (Either Solid or Stranded)
Strip Length: 9 mm (3/8 in.) - Torque: 0.8 N•m (7 lb•in)
Total height: 700-HN122 + 700-HNK42 is 78.0 mm.

700-HR Dial Timing Relays



- Socket- or panel-mounted
- 5 A contact ratings or transistor outputs
- Single- or Multi-Function
- Timing range from 0.05 s...300 h
- Multi-voltage inputs

Multi-Function Timing Relays with Trigger and Reset Switch Options

Description	Timing Mode	Supply Voltage	Trigger Options	Reset Options	Outputs	Cat. No.
<ul style="list-style-type: none"> • Socket or Panel Mounted • Timing Range 0.05 s...300 h • 11-pin base for socket cat. nos. 700-HN101, -HN126, -HN129 • Trigger: Power on or optional trigger signal • Reset: Power off or optional reset signal 	On-delay (A) OFF-Delay (D) One Shot (E) Repeat cycle OFF-Start (B) Repeat Cycle ON-Start (B2) Signal ON/OFF-delay (C) Delayed One Shot (J) Signal ON/OFF - Delay (G)	24...48V AC 12...48V DC	1. Power On 2. Start Signal - contact closure (zero volts) - NPN transistor 3. Gate Signal (pause)	1. Power Off 2. Reset Signal - contact closure (zero volts) - NPN transistor	DPDT	700-HR52TU24
			1. Power On 2. Start Signal - contact closure (voltage) - NPN transistor - PNP transistor	Power Off	DPDT	700-HRV52TU24
		100...240V AC 100...125V DC	1. Power On 2. Start Signal - contact closure (zero volts) 3. Gate Signal (pause)	1. Power Off 2. Reset Signal - contact closure (zero volts)	DPDT	700-HR52TA17
			1. Power On 2. Start Signal - contact closure (voltage)	Power Off	DPDT	700-HRV52TA17 ⁽¹⁾

(1) Voltage input connection to high signal instead of 0V signal.

Multi-Function Timing Relays with Power On Trigger

Description	Timing Mode	Supply Voltage	Trigger Options	Reset Options	Outputs	Cat. No.
<ul style="list-style-type: none"> • Socket or Panel Mounted • Timing Range 0.05 s...300 h • 8-pin base for socket cat. nos. 700-HN100, -HN125, -HN108 • Trigger: Power on • Reset: Power off 	On-delay (A) One Shot (E) Repeat Cycle OFF-Start (B) Repeat Cycle ON-Start (B2) Delayed One Shot (J)	24...48V AC 12...48V DC	Power On	Power Off	DPDT	700-HRS42TU24
					Transistor	700-HRT4TTU24 ⁽¹⁾
		100...240V AC 100...125V DC	Power On	Power Off	SPDT Timed + Instantaneous Contact	700-HRP42TU24 ⁽¹⁾
					SPDT Timed + Instantaneous Contact	700-HRP42TA17
DPDT	700-HRS42TA17					

(1) Voltage input connection to high signal instead of 0V signal.

On-delay Timing Relays

Description	Timing Mode	Supply Voltage	Trigger Options	Reset Options	Outputs	Cat. No.
<ul style="list-style-type: none"> • Socket or Panel Mounted • Timing Range From 0.05 s...300 h • 8-pin base for socket cat. nos. 700-HN100, -HN125, -HN108 • Trigger: Power on • Reset: Power off 	On-delay (A)	24...48V AC/DC	Power On	Power Off	SPDT Timed + Instantaneous Contact	700-HRC12TU24
		24...48V AC, 12...48V DC			DPDT	700-HRM12TU24
		100...240V AC	Power On	Power Off	DPDT	700-HRM12TA17
					SPDT Timed + Instantaneous Contact	700-HRC12TA17

Timing Mode Description

A	D	E	B	B2	C	J	G
ON-Delay	OFF-Delay	One Shot	Repeat Cycle OFF-Start	Repeat Cycle ON-Start	Signal ON/OFF-Delay	Delayed One Shot	Signal ON/OFF-Delay

700-HRF Repeat Cycle Timing Relays

Description	Cat. No. Explanation						
	700	-	HRF	7	2	D	U26
	a		b	c	d	e	f
<ul style="list-style-type: none"> • Socket or Panel Mounted • Independently adjustable on- and off-time • 8-Pin base for socket cat. nos. 700-HN100, -HN125, and -HN108 • DPDT contact outputs • Trigger: Power on • Reset: Power off • Hazardous location version available 	a Bulletin Number	-	b Type of Relay	c Function	d Contact Output	e Timing Range	f Supply Voltage
	700		HRF-Repeat cycle with adjustable ON/OFF times	7 - Repeat cycle with OFF start 8 - Repeat cycle with ON start	2- DPDT	D- 0.05 s...300 h	U26 - 12...48V DC, 24...48V AC U27 - 100...125V DC, 100...240V AC

700-HRY Star-Delta Timing Relays



Description	Cat. No. Explanation					
	700	-	HR-Y	6	F	A12
	a		b	c	d	e
<ul style="list-style-type: none"> • 8-Pin base for socket cat. nos. 700-HN100, -HN125, and -HN108 • SPDT timed + instantaneous contact outputs • Trigger: Power on • Reset: Power off 	a Bulletin Number	-	b Type of Relay	c Function	d Timing Range	e Supply Voltage
	700		HRY-Y Star-Delta timer	6 -SPDT timed + SPDT instant	F-Star: 0.5...120 s Delta: 0.05, 0.1, 1.25, 0.5, 0.75, 1.0 s	A12-100...120V AC, 50/60 Hz A22-200...240V AC, 50/60 Hz

700-HRQ True Off-delay Timing Relays








Description	Cat. No. Explanation						
	700	-	HRQ	N	2	G	A12
	a		b	c	d	e	f
<ul style="list-style-type: none"> • 11-Pin base for use with reset option – socket cat. nos. 700-HN101, -HN126, and -HN129 • 8-Pin base for use without reset option – socket cat. nos. 700-HN100, -HN125, and -HN108 • DPDT contact outputs • Trigger: Power off • Reset: optional reset signal 	a Bulletin Number	-	b Type of Relay	c Function	d Contact Output	e Timing Range	f Supply Voltage
	700		HRQ-True Off-delay Timer	N-No reset option, 8-pin terminals R-Reset option, 11-pin terminals	2- DPDT	G-0.05...12 s H-0.05 s...12 min	A12-100...120V AC, 50/60 Hz A22-200...240V AC, 50/60 Hz U25-24V AC, 50/60 Hz; 24V DC Z48-48V DC Z11-100...125V DC

Accessories

Sockets and DIN Rail

	Description	For Use With	Pkg. Qty.	Cat. No.
	Screw Terminal Tube Base Socket <ul style="list-style-type: none"> • Panel or DIN Rail Mounting • 8-Pin 	<ul style="list-style-type: none"> • Guarded Terminal Construction 	10	700-HN100
				

Sockets and DIN Rail

	Description	For Use With	Pkg. Qty.	Cat. No.
	Screw Terminal Tube Base Sockets • Panel or DIN Rail Mounting • 11-pin	• Guarded Terminal Construction 3PDT 700-HA Relays	10	700-HN101
		• Open Style Construction • No retainer clip required 3PDT 700-HA Relays	10	700-HN126
	DIN (#3) symmetrical hat rail • 35 x 7.5 x 1 m		10	199-DR1
	Specialty Socket • Backwired socket with solder terminals • Order 10 or multiples of 10.	8-pin 700-H timing relays	10	700-HN108
		11-pin back-wired socket with solder terminals 700-H timing relays	10	700-HN129
	Frame Adapter • For flush or door mounting of all 700-H and -HX timers.	700-H and -HX timers	1	700-HN130
	Retainer Clip for Cat. Nos. • Secures timer in socket • Not required for installation	700-HN100 and -HN101 Sockets with all 700-H Timing Relays	10	700-HN131
	Protective Cover • Helps prevent tampering of timing and mode settings • Provides a degree of protection against water and dirt from entering the front of the relay	all 700-HR and -HX timing relays	1	700-HN132

Socket and Retainer Clip Reference

Timer Cat. No.	Socket	Retainer Clip
700-HR52, -HRT6, -HRV, -HRQR	700-HN101 ⁽¹⁾	700-HN131
	700-HN126 ⁽¹⁾	Not Required ⁽³⁾
	700-HN129 ⁽¹⁾	Not Applicable


Timer Cat. No.	Socket	Retainer Clip
700-HRS, -HRT4, -HRP, -HRC, -HRM, -HRF, -HRY, -HRQN	700-HN100 ⁽²⁾	700-HN131
	700-HN108 ⁽²⁾	Not Applicable
	700-HN125 ⁽²⁾	Not Required ⁽³⁾

(1) 11 pins.

(2) 8 + pins.

(3) The design of these sockets holds the timing relays securely and does not require retainer clips.

Marking Systems

Photo	Description	Pkg. Qty.	Cat. No.
	Pre-printed Identification Tags • Contains 10 sheets of pre-printed and blank tags • Each sheet contains 13 sets of the markings CR...9CR, TR...9TR, M...9M, F, R, 1S, and 117 blank tags • Tags are peel-off with sticky backing for easy placement on relays	10	700-N40
	Blank Identification Tags • contains 10 sheets of blank identification tags for customer specialized printing • Each sheet contains 546 blank tags • Tags are peel-off with sticky backing for easy placement on relays.	10	700-N41

Specifications

Table 99 - General Ratings

	700-H, 700-HRS, 700-HRV	700-HRP	700-HRC	700-HRM	700-HRF	700-HRY	700-HRQ	700-HRT (Transistor Outputs)
Electrical Ratings								
Pilot Duty Rating	NEMA B300							–
Thermal Current (I_{th})	5 A							100 mA @ 30V DC max
Make ▶ ◀	120V AC	30 A						–
	240V AC	15 A						–
Break ◀ ▶	120V AC	3 A						–
	240V AC	1.5 A						–
Hp at 120V	1/6 Hp (0.12 kW)	1/4 Hp (0.18 kW)	1/6 Hp (0.12 kW)		1/4 Hp (0.18 kW)	1/6 Hp (0.12 kW)		–
Hp at 240V	1/3 Hp (0.25 kW)							–
Resistive Load	5 A at 250V AC/30V DC							
Inductive Load	AC-15 @ 250V AC, 3 A/DC-13 @ 30V DC, 0.5 A							
Accuracy of Operating Time	±0.2% FS max (±0.2% ±10 ms max in a range of 1.2 s)							
Setting Error	±5 % FS ±50 ms (The value is ±5% FS +100 ms to -0 ms max when the C or D mode signal of the 700-HRVs are OFF.)							
Influence of Voltage	±0.2% FS max (±0.2% ±10 ms max in a range of 1.2 s)							
Influence of Temperature	±1% FS max (±1% ±10 ms max in a range of 1.2 s)							
Permissible Leakage Current								
Power Consumption	-HR52, -HRS	-HRV	-HRP, -HRC	-HRM	-HRF	-HRY	-HRQ	-HRT
240V AC, Output ON	2.1 VA	2.5 VA	2.0 VA	2.1 VA	10 VA	12 VA	0.4 VA	–
240V AC, Output OFF	1.3 VA	1.8 VA	2.0 VA	1.3 VA	10 VA	12 VA	0.4 VA	–
24V DC, Output ON	0.8 W	0.9 W	0.9 W	0.8 W	1.0 W	–	0.2 W	0.3 W
24V DC, Output OFF	0.2 W	0.3 W	0.9 W	0.2 W	1.0 W	–	0.2 W	0.2 W
Design Specifications								
Dielectric Strength	2000V AC (1000V AC for 700-HRT), 50/60 Hz for 1 min (contact to frame) 2000V AC (1000V AC for 700-HRT), 50/60 Hz for 1 min (between control output terminals and operating circuit) 2000V AC, 50/60 Hz for 1 min (pole-to-pole) 1000V AC, 50/60 Hz for 1 min (between contacts not located next to each other) 2000V AC, 50/60 Hz for 1 min (contact to coil)							
Mechanical								
Vibration Resistance	Malfunction: 10...55 Hz with 0.5 mm double amplitude each in three directions for ten minutes each							
Shock Resistance	Malfunction: 100 m/s ² (10 G)				98 m/s ² (10 G)	294 m/s ² (10 G)	98 m/s ² (10 G)	100 m/s ² (10 G)
Environmental								
Noise Immunity	±1.5 kV for ±600V DC				±400V for 12V DC		±1kV for 48V DC	±1.5 kV for ±600V DC
Static Immunity	Malfunction: 8 kV							
Ambient Temperature	Operating: -10...+55 °C (14...131 °F) with no icing Storage: -25...+65 °C (13...149 °F) with no icing							
Ambient Humidity	Operating: 35...85 %							
Construction								
Life Expectancy (min Operations)	Mechanical: 20 000 000. (under no load at 1800 operations/h) Electrical: 100 000 (5 A at 250V AC, resistive load at 1800 operations/h)						Mech: 10 ⁷ Electrical: 10 ⁴	
EMC	(EMI) EN50081-2 Emission Enclosure: EN55011 Group 1 class A Emission AC Mains: EN55011 Group 1 class A (EMS) EN50082-2 Immunity ESD: EN61000-4-2: 4 kV contact discharge (level 2); 8 kV air discharge (level 3) Immunity RF-interference from AM Radio Waves: ENV50140: 10 V/m (80 MHz...1.1 GHz) (level 3) Immunity RF-interference from Pulse-modulated Radio Waves: ENV50204: 10 V/m (900 ±5 MHz) (level 3) Immunity Conducted Disturbance: ENV50141: 10V (0.15...80 MHz) (level 3) Immunity Burst: EN61000-4-4: 2 kV power-line (level 3) Immunity Surge: EN61000-4-52 kV I/O signal-line (level 4) 1 kV line to line; 2 kV line to ground (level 3)							

Table 99 - General Ratings (Continued)

	700-H, 700-HRS, 700-HRV	700-HRP	700-HRC	700-HRM	700-HRF	700-HRY	700-HRQ	700-HRT (Transistor Outputs)
Degree of Protection	IP40 (panel surface)							
Weight	Approx. 90 g							
Certifications	CSA Certified (File No. 70751), UL Recognized (File No. E14843 Guide No. NRNT2), CE Marked, C-Tick Marked							
Standards	UL 508, CSA C22.2 No. 14, EN 61812-1, EN 61000-6-2, -6-4							

Timer Functions

Figure 90 - 700-H Multifunction Timer

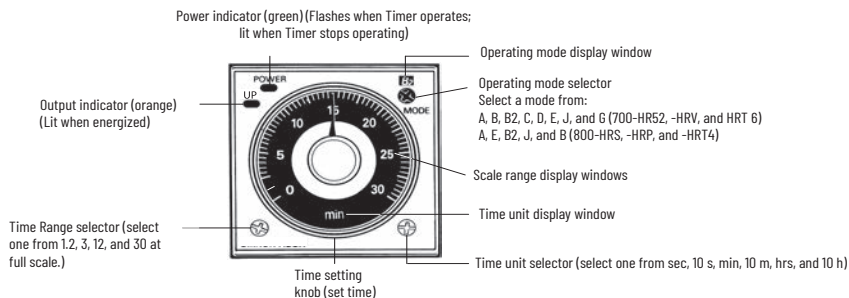


Figure 91 - 700-HRC -HRM On-delay Timer

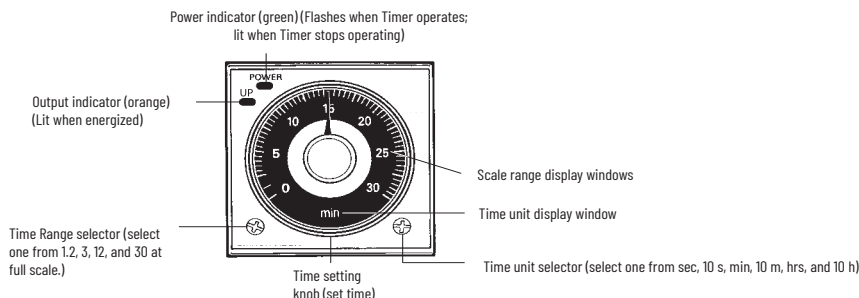


Figure 92 - 700-HRF Twin Timer

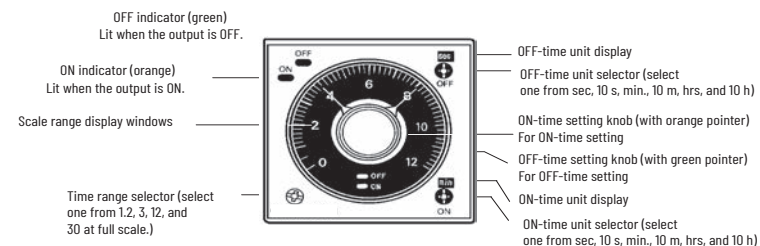


Figure 93 - 700-HRY Star-Delta Timer

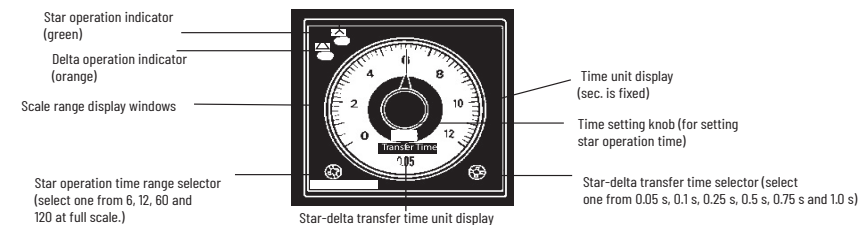
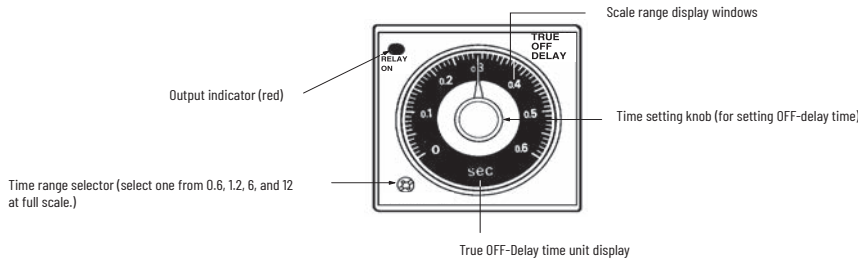


Figure 94 - 700-HRQ True Off-delay Timer

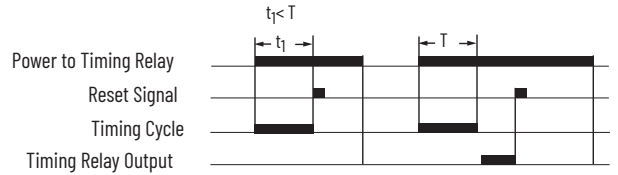


Specifications for Start, Gate, Reset Signal (Cat. Nos. 700-HR52, -HRT6, -HRV, -HRQR)

Start, Reset, and Gate signals are typically contact closures or signals from a solid-state sensor.

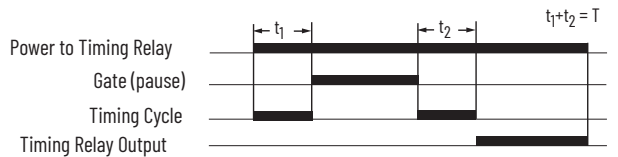
(R) Reset Signal

The reset signal is not required for normal operation. Reset can be accomplished by removing power from the timing relay. To reset the timer without removing power, a signal must be applied which resets the timing cycle and returns the output contacts to their shelf state. The reset signal will override both the start signal and gate signal. The reset signal can be either momentary or maintained.



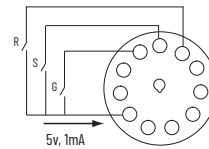
(G) Gate Signal

The gate signal is not required for normal operation. The gate signal provides a pause or retentive timing function. When the gate signal is applied the timing cycle is momentarily interrupted. When the signal is removed, the timing cycle resumes timing at the point the cycle was interrupted and will continue timing until the time delay is completed or the gate signal is re-applied.



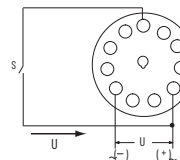
Contact Signal – Cat. Nos. 700-HR52, -HRT6, -HRQR

Contact closure provides signal to timer. A low energy signal is generated by the 700-H timing relay. For optimum reliability, use contacts designed for low energy switching (5V, 1 mA) (Bul. 800F-X V, 800T-X V). No external voltage should be connected to the contact signal.



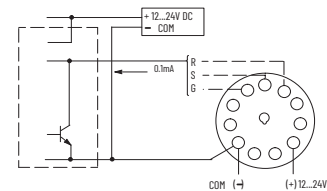
Contact Signal – Cat. No. 700-HRV

For use in applications where it is not possible to use contacts designed for low energy switching. Contact closure provides signal to timer. A signal is generated by the 700-h timing relay, and is the same potential as the supply voltage of the timing relay. No external voltage should be connected to contact signal. 700-HRV52TU24 supply voltage: 24...48V AC, 12...48V DC / 700-HRV52TA17 supply voltage: 100...240V AC, 100...125V DC.



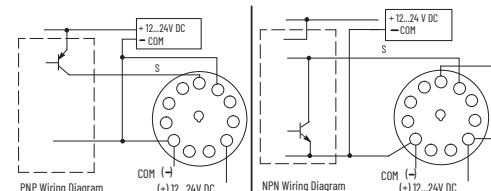
Solid-State Signal – Cat. Nos. 700-HR52, -HRT6

Timing relay is suitable for use with a 3-wire NPN 12...24V DC sensor. Supply voltage potential of sensor must be the same as the supply voltage potential of the timing relay. Permissible off-state leakage current from sensor: 0.01 mA max



Solid-State Signal – Cat. No. 700-HRV

Timing relay is suitable for use with a 3-wire NPN or PNP 12...24V DC sensor. Supply voltage potential of sensor must be the same as the supply voltage potential of the timing relay. Permissible off-state leakage current from sensor: 0.01 mA max



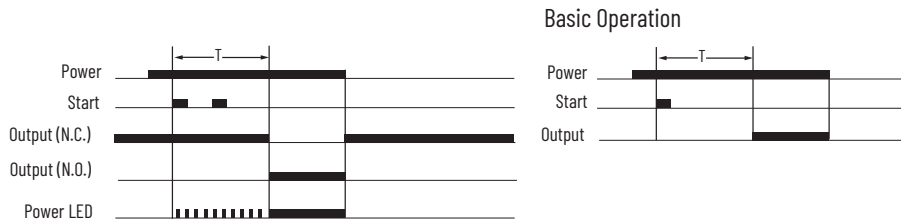
Signal Specifications

Circuit Impedance	Circuit impedance can be used to calculate the maximum wiring distance from the signal switch to the timing relay, for example. Permissible signal-ON impedance: 1 kΩ max Permissible signal-OFF impedance: 100 kΩ min				
Power-OFF Reset	Min power-off time: 0.1 s, Reset Voltage: 10% max of rated voltage				
Signal Duration	Min pulse width: 0.05 s				
Signal Options		700-HR52	700-HRT6	700-HRV5	700-HRQR
	Start	X	X	X	NA
	Reset	X	X	NA	X
	Gate	X	X	NA	NA

Timing Charts

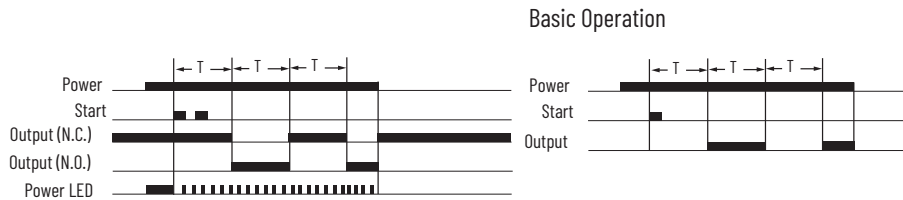
Mode A – On-delay

- a. Needs continuous input power applied.
- b. Timing is initiated by the leading edge of the start signal.
- c. Contacts change state after timing is complete.
- d. Additional start signals during timing don't reset timing or contacts.
- e. When the input power is removed contacts return to shelf state.



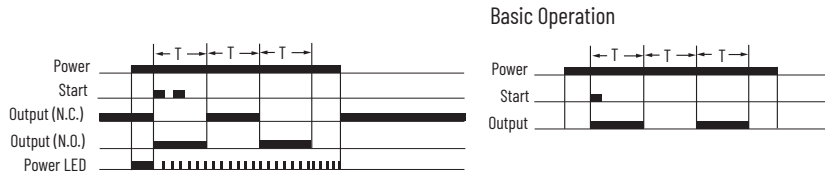
Mode B – Repeat Cycle, Off Start

- a. Need continuous input power applied.
- b. Timing is initiated by the leading edge of the start signal. Additional start signals during timing do not reset timing or contacts.
- c. For the first time period the contacts remain in their shelf state. When that time period is complete contacts change state for the same time period (time on = time off).
- d. This cycle repeats itself until input power is removed or reset signal is applied. When the input power is removed or reset signal is applied contacts return to the shelf state.



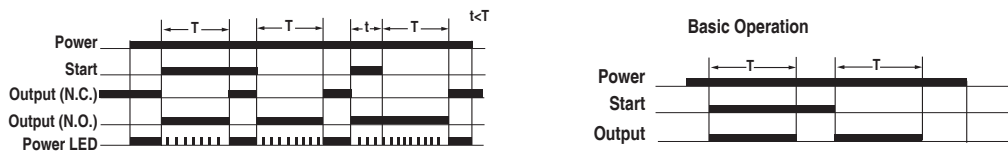
Mode B2 – Repeat Cycle On start

- a. Need continuous input power applied.
- b. Timing is initiated by the leading edge of the start signal. Additional start signals during timing do not reset timing or contacts.
- c. For the first time period the contacts change state. When that time period is complete contacts return to the shelf state for the same time period (time on = time off).
- d. This cycle repeats itself until input power is removed or reset signal is applied. When the input power is removed or reset signal is applied contacts return to the shelf state.



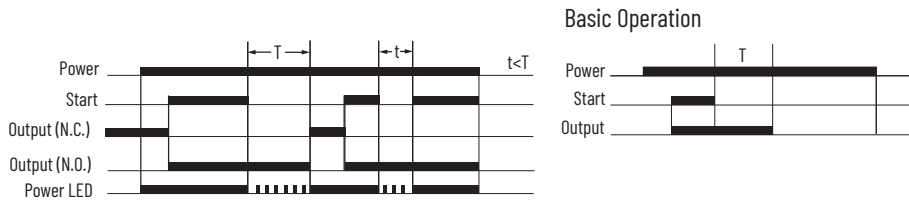
Mode C – Watchdog monitor (Trigger = Signal On/Off)

- a. Need continuous input power applied.
- b. Contacts change state immediately when start signal is applied or when start signal is removed (only if timing cycle was complete).
- c. Timing is initiated at the leading edge of the start signal. After the first timing cycle is complete, timing is initiated by the trailing edge of the start signal.
- d. At the end of the time period contacts return to the shelf state.
- e. Relay timing is reset when additional start signals are applied while the relay is timing. Contacts remain in energized state.
- f. When the input power is removed contacts return to the shelf state.



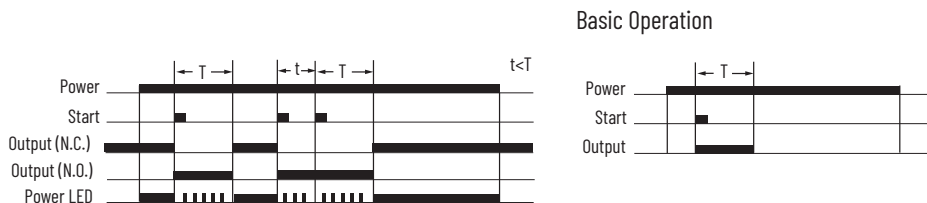
Mode D – Off-delay (Trigger = Signal Off)

- a. Need continuous input power applied.
- b. Contacts change state immediately when start signal is applied.
- c. Timing is initiated by the trailing edge of the start signal.
- d. At the end of the time period contacts return to the shelf state.
- e. Relay timing is reset when additional start signals are applied while the relay is timing. Contacts remain in energized state.
- f. When the input power is removed contacts return to the shelf state.



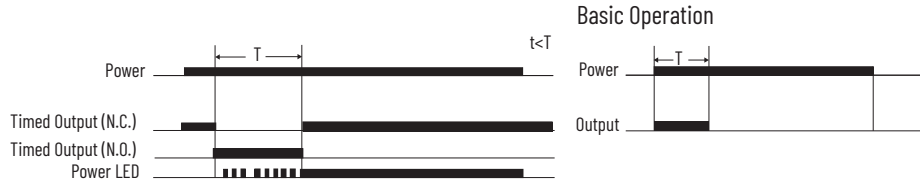
Mode E – One-Shot (Trigger = Signal On) 700-HR52, -HRV, and -HRT6

- a. Need continuous input power applied.
- b. Timing is initiated by the leading edge of the start signal.
- c. Contacts change state immediately when start signal is applied.
- d. At the end of the time period contacts return to the shelf state.
- e. Relay timing is reset when additional start signals are applied while the relay is timing. Contacts remain in energized state.
- f. When the input power is removed contacts return to shelf state.



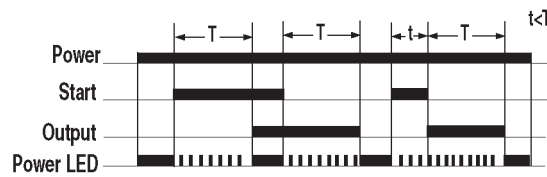
Mode E – One-Shot (Trigger = Power On) 700-HRS, -HRP, and -HRT4

- a. Need continuous input power applied.
- b. Timing is initiated when the input power is applied.
- c. At the end of the time period contacts return to the shelf state.
- d. Relay timing is reset when input power is removed.



Mode G – Watchdog Monitor (Trigger = Signal ON/OFF)

- a. Need continuous input power applied.
- b. Timing is initiated by the landing edge of the start signal.
- c. After the first timing cycle is complete the contacts change state and timing is initiated by the trailing edge of the start signal.
- d. At the end of the time period the contacts return to the shelf state.
- e. Relay timing is reset when additional start signals are applied while the relay is timing.
- f. When the power is removed contacts return to the shelf state.



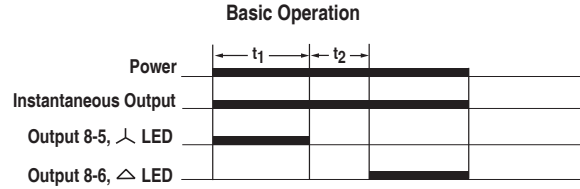
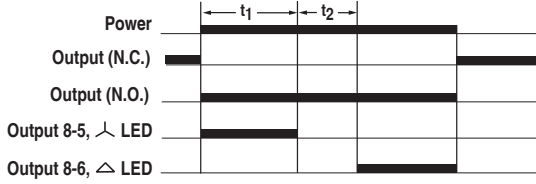
Mode J – Delayed One-Shot (Trigger = Power On)

- a. Need continuous input power applied.
- b. No start signal applied.
- c. Timing is initiated when input power is applied.
- d. Contacts change state after the timing for a fixed time of $1s \pm 0.5s$
- e. At the end of the 1 sec period the contacts return to the shelf state.
- f. When the input power is removed contacts return to the shelf state.



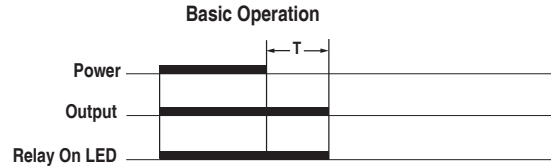
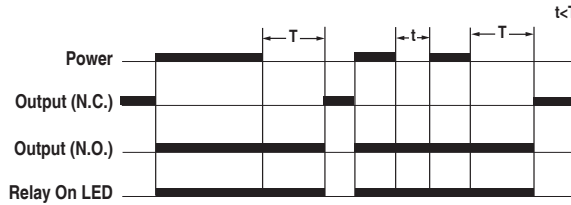
Mode Star-Delta

- a. Need continuous input power applied.
- b. No start signal required. Timing is initiated when input power is applied.
- c. Star output contact changes state when input power is applied.
- d. After timing is complete star output contact returns to the shelf state then both the star & delta contacts remain in shelf states until transfer time setting is complete.
- e. Delta output contact changes state after transfer time is complete.
- f. Instantaneous contact changes state when input power is applied.
- g. All contacts return to the shelf state when input power is removed.



Mode True Off-delay (Trigger = Power Off)

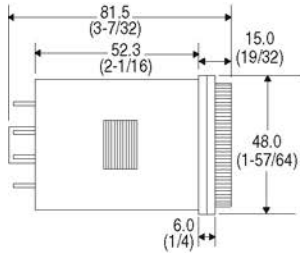
- a. Continuous input power is NOT required.
- b. No start signal applied.
- c. Contacts change state immediately when input power is applied.
- d. Timing starts when input power is removed.
- e. At the end of the time period contacts return to the shelf state.
- f. Relay timing is reset when input power is reapplied while the relay is timing. Contacts remain in energized state.



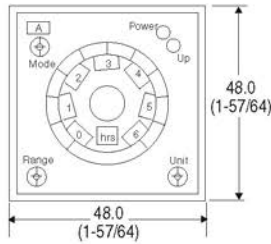
Approximate Dimensions

Approximate dimensions are shown in millimeters (inches). Dimensions are not intended for manufacturing purposes.

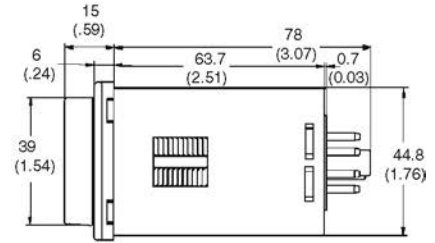
Figure 95 - 700-HR Timing Relays



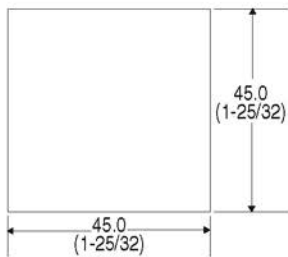
Cat. No. 700-HR, -HRM, -HRC, -HRF, -HRS, HRV, HRP Timing Relays



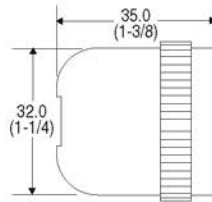
Cat. No. 700-HR, -HRM, -HRC, -HRF, -HRS, -HRV, -HRP, -HRY, -HRQ Timing Relays



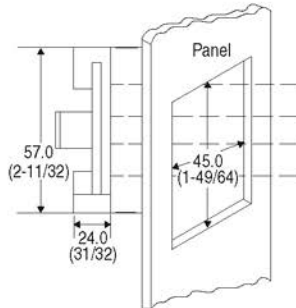
Cat. No. 700-HRY, -HRQ Timing Relays



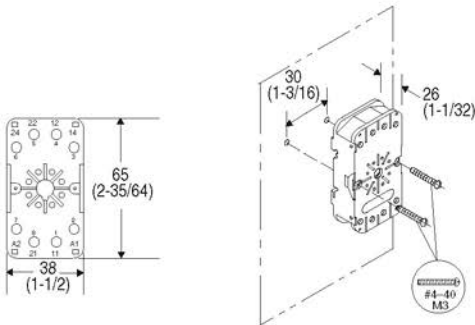
Cat. No. 700-HR... Panel Cutout



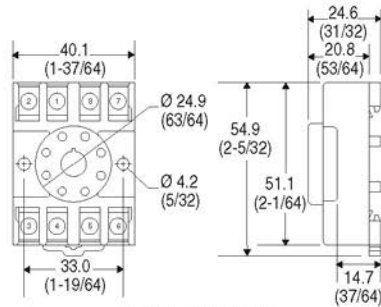
Cat. No. 700-HN129 — 11-pin
Cat. No. 700-HN108 — 8-pin socket



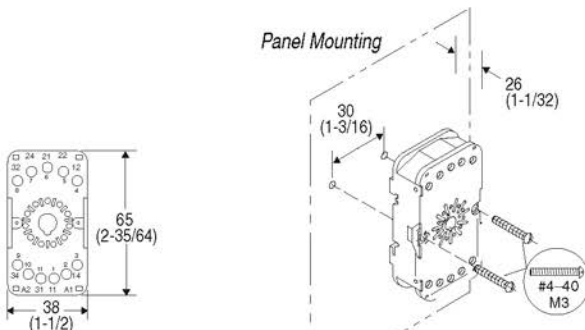
Cat. No. 700-HN130 Retainer



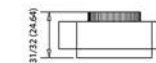
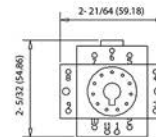
Cat. No. 700-HN100
Wire Size: 2x2.5 mm
Single Wire — Up to #12 AWG
Double Wire — 2x2.5 mm (#2-14 AWG...#2-20 AWG)
(Either Solid or Stranded)
Strip length: 9 mm (3/8 in) — Torque: 0.8 N•m (7 lb•in)



Cat. No. 700-HN125
Wire Size: 2x2.5 mm
Single Wire — Up to #12 AWG
Double Wire — 2x2.5 mm (#2-14...#2-20 AWG)
(Either Solid or Stranded)
Strip Length: 9 mm (3/8 in) — Torque: 0.8 N•m (7 lb•in)



Cat. No. 700-HN101
Wire Size: 2x2.5 mm
Single Wire — Up to #12 AWG
Double Wire — 2x2.5 mm (#2-14 AWG...#2-20 AWG)
(Either Solid or Stranded)
Strip Length: 9 mm (3/8 in.) — Torque: 0.8 N•m (7 lb•in.)



Cat. No. 700-HN126
Wire Size: 2x2.5 mm
Single Wire — Up to #12 AWG
Double Wire — 2x2.5 mm (#2-14...#2-20 AWG)
(Either Solid or Stranded)
Strip Length: 9 mm (3/8 in) — Torque: 0.8 N•m (7 lb•in)

700-HT Timing Relays

- Timing Relay (On-delay or Off-delay)
- Rugged Pin Style Socket Mounting
- 10 A, DPDT Contact Ratings
- 2 Form C Contacts



700-HT



700-HTF

700-HT Single Range Timing Relay with Pin Style Terminations

Description	Cat. No. Explanation						
	700	-	HT	2	2	A	A2
	a		b	c	d	e	f
<ul style="list-style-type: none"> • Rugged Pin Style Socket Mounting • 0.1 s...30 min Fixed Timing Relay • 0.1 s...3 min Single Adjustable Timing Relay • Single or Fixed Timing 	a Bulletin Number	-	b Type of Relay	c Function	d Contact Output	e Timing Range	f Supply Voltage
	700		HT - Tube Base Adjustable Timing Relay	1-On-delay 2- Off-delay	2- DPDT	A- 0.1...10 s B- 1.0...100 s C- 0.1...10 min D- 1.0...100 min E - 0.1...10 h	U12- 12V DC U24- 24V AC/DC, 50/60 Hz U120- 120V AC/DC, 50/60 Hz A2 - 240V AC, 50/60 Hz

700-HTF Fixed Timing Relay with Plug-in Tube Base

Description	Cat. No. Explanation							
	700	-	HTF	2	2	025	S	A2
	a		b	c	d	e	f	g
<ul style="list-style-type: none"> • Fixed Timing - adjustment knob removed to help prevent unwanted tampering • Setting time is ±5% of the time ordered 	a Bulletin Number	-	b Type of Relay	c Function	d Contact Output	e Timing Range	f Timing Units	g Coil Voltage
	700		HTF- Tube Base Fixed Timing Relay	1-On-delay 2- Off-delay	2- DPDT	001...999 ⁽¹⁾	S- Seconds M - Minutes H - hours	U12- 12V DC U24- 24V AC/DC, 50/60 Hz U120- 120V AC/DC, 50/60 Hz A2 - 240V AC, 50/60 Hz

(1) The three digit code represents a numeric value with one decimal place. For example: code 001 is 0.1, code 025 is 2.5, and code 999 is 99.9. The acceptable range for each time unit is :
 Seconds - 001...999
 Minutes - 001...999
 Hours - 001...100

Operating Mode	Wiring Diagrams	
	U.S./Canada	International
On-delay		
Socket Cat. No.	700-HN125 or 700-HN100	700-HN100

Operating Mode	Wiring Diagrams	
	U.S./Canada	International
Off-delay		
Socket Cat. No.	700-HN126 or 700-HN101	700-HN101

Socket and Retainer Clip Reference







Timer Cat. No.	Socket	Retainer Clip
700-HT12	700-HN100	700-HN131
	700-HN125	Not Required ⁽¹⁾

Timer Cat. No.	Socket	Retainer Clip
700-HT22	700-HN101	700-HN131
	700-HN126	Not Required ⁽³⁾


(1) The design of these sockets holds the timing relays securely and does not require retainer clips.

Accessories

Sockets and DIN Rail

	Description		For Use With	Pkg. Qty.	Cat. No.
	Screw Terminal Tube Base Socket • Panel or DIN Rail Mounting • 8-Pin	• Guarded Terminal Construction	DPDT 700-HA Relays -HX Timing Relays -HT (On-delay) Timing Relays -HRM, -HRC and -HV (Repeat Cycle) Timing Relays	10	700-HN100
		• Open Style Construction • No retainer clip required	DPDT 700-HA Relays -HT (On-delay) Timing Relays -HRM, -HRC and -HV (Repeat Cycle) Timing Relays	10	700-HN125
	Screw Terminal Tube Base Sockets • Panel or DIN Rail Mounting • 11-pin	• Guarded Terminal Construction	3PDT 700-HA Relays	10	700-HN101
		• Open Style Construction • No retainer clip required	3PDT 700-HA Relays	10	700-HN126
	DIN (#3) symmetrical hat rail • 35 x 7.5 x 1 m			10	199-DR1
	Retainer Clip for Cat. Nos. • Secures timer in socket • Not required for installation		700-HN100 and -HN101 Sockets with all 700-HT Timing Relays	10	700-HN110

Marking Systems

Photo	Description	Pkg. Qty.	Cat. No.
	Pre-printed Identification Tags • Contains 10 sheets of pre-printed and blank tags • Each sheet contains 13 sets of the markings CR...9CR, TR...9TR, M...9M, F, R, 1S, and 117 blank tags • Tags are peel-off with sticky backing for easy placement on relays	10	700-N40
	Blank Identification Tags • contains 10 sheets of blank identification tags for customer specialized printing • Each sheet contains 546 blank tags • Tags are peel-off with sticky backing for easy placement on relays.	10	700-N41

Specifications

Table 100 - General Ratings

		Cat. No. 700-HT...			Cat. No. 700-HTF...		
Electrical Ratings							
Pilot Duty Rating ⁽¹⁾		NEMA B300					
Rated Thermal Current (I_{th})		10 A					
Rated Insulation Voltage (U_i)		250V IEC, 300V UL/CSA					
Contacts	Inductive	Make	Break	Hp	Make	Break	Hp
		►][◄	◄][►		►][◄	◄][►	
	120V AC	30 A	3 A	1/2 N.O. 1/3 N.C	30 A	3 A	1/3
	240V AC	15 A	1.5 A	1/2 N.O. 1/3 N.C	15 A	1.5 A	1/2
	Resistive 28V DC	10 A	10 A	—	10 A	10 A	—
Permissible Coil Voltage Variation		85...110% of Nominal Voltage at 50 Hz 85...110% of Nominal Voltage at 60 Hz 80...110% of Nominal Voltage at DC					
Power Consumption ±10%	AC	24V AC	2 VA				
		120V AC	4 VA				
		240V AC	4 VA				
	DC	1.3 W					
Design Specification/Test Requirements							
Dielectric Withstand Voltage	Pole-to-Pole, same circuit (VRMS)		1000V AC				
	Pole-to-Pole, different circuits (VRMS)		2000V AC				
	Contact-to-Coil (VRMS)		2000V AC				
Electrical Life Operations		100,000 minimum					
Switching Frequency Operations		1800/h					
Coil Voltages		See product selection					
Mechanical							
Degree of Protection		Open Type (Guarded Terminal Sockets)					
Mechanical Life Operations		10 x 10 ⁶					
Switching Frequency Operations		18,000/h					
Timing	Duty Cycle	Continuous					
Repeat Accuracy (constant voltage and temperature)		±2% (Time Delay: 0.1...2 s) ±1% (Time Delay: >2 s)					
Repeat Accuracy (variable voltage and temperature)		±10%					
Fixed Time Setting Accuracy		—			±5% (Time Delay: 0.1...2 s) ±1% (Time Delay: >2 s)		
Scale Tolerance	High End of Range	+5%			—		
	Low End of Range	-50%			—		
Reset Time	ON Delay	100 ms					
	OFF Delay	40 ms					
Environmental							
Temperature	Operating	-28...+65 °C (50 °C max, 240V AC coil) (-18...+149 °F)(122 °F max, 240V AC coil)					
	Storage	-55...+85 °C (-67...+185 °F)					
Altitude		2000 m (6560 ft)					
Construction							
Insulating Material		Molded High Dielectric Material					
Enclosure		Impact Resistant Dust Cover					
Contact Material		Silver Cadmium Oxide					
Terminal Markings on Socket		In accordance with EN50 005					

Table 100 - General Ratings

	Cat. No. 700-HT...	Cat. No. 700-HTF...
Sockets	8- or 11-Pin Socket (On = 8, Off = 11) 700-HN100, -HN125 700-HN101, -HN126	
Certifications	CSA Certified, File 223833, UL Recognized, File E3125 Guide NLDX 2, UL Listed, when used with 700-HN100, 700-HN101, 700-HN125, and 700-HN126 Sockets, File No. E3125 Guide NLDX, CE Marked	
Standards	EN 61812-1, CSA 22.2 No. 14, UL 508	

(1) See [NEMA Ratings and Test Values on page 5](#).

Trigger Signal

Contact closure provides signal to timer. A low energy signal is generated by the 700-HT timing relay. For optimum reliability, use contacts designed for low energy switching (10V, 1 mA) (Bul. 800F-X__V, 800T-X__V). No external voltage should be connected to the contact signal.

Timing Diagrams

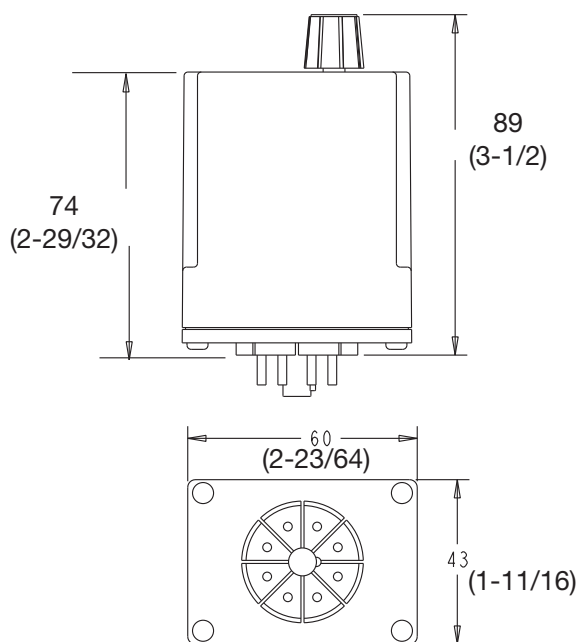
Figure 96 - Timing Diagrams for 700-HT Relays



Approximate Dimensions

Approximate dimensions are shown in millimeters (inches). Dimensions are not intended for manufacturing purposes.

Figure 97 - 700-HT Relays



700-HV Timing Relay

- Repeat Cycle Timing Relay
- 10 A Contact Rating
- DPDT
- 2 Form C Contacts
- Pin Style Terminals
- 0.1 s...30 min
- Repeat Cycle Adjustable Timing
- Two Timing Adjustments T1 ≠ T2



700-HV Repeat Cycle Timing Relays with Pin Style Terminations with 2 Adjustments (T1 ≠ T2)

Cat. No. Explanation							
700	-	HV	3	2	A	A	A2
a	-	b	c	d	e	f	g
a Bulletin Number	-	b Type of Relay	c Operating Mode	d Contact Output	e Timing Range OFF Time	f Timing Range ON Time	g Supply Voltage
700	-	HV - Tube Base Repeat Cycle Timing Relay	3 - Power ON Repeat Cycle, OFF Start (Repeat Cycle, OFF/ON Delay)	2- DPDT	Code OFF Time — Type HV A - 0.1...10 s B - 1.0...100 s C - 0.1...10 min D - 1.0...100 min E - 0.1...10 h	Code ON Time — Type HV A - 0.1...10 s B - 1.0...100 s C - 0.1...10 min D - 1.0...100 min E - 0.1...10 h	U12- 12V DC U24- 24V AC/DC, 50/60 Hz U120- 120V AC/DC, 50/60 Hz A2 - 240V AC, 50/60 Hz

Operating Mode	Wiring Diagrams	
	U.S./Canada	International
On-delay		
Socket Cat. No.	700-HN125 or 700-HN100	700-HN100




Socket and Retainer Clip Reference

Timer Cat. No.	Socket	Retainer Clip
700-HV	700-HN100	700-HN110
	700-HN125	Not Required ⁽¹⁾


(1) The design of these sockets holds the timing relays securely and does not require retainer clips.

Accessories

Sockets and DIN Rail

	Description	For Use With	Pkg. Qty.	Cat. No.
	Screw Terminal Tube Base Socket • Panel or DIN Rail Mounting • 8-Pin	<ul style="list-style-type: none"> Guarded Terminal Construction 	10	700-HN100
				
	DIN (#3) symmetrical hat rail • 35 x 7.5 x 1 m		10	199-DR1

Marking Systems

Photo	Description	Pkg. Qty.	Cat. No.
	Pre-printed Identification Tags • Contains 10 sheets of pre-printed and blank tags • Each sheet contains 13 sets of the markings CR...9CR, TR...9TR, M...9M, F, R, 1S, and 117 blank tags • Tags are peel-off with sticky backing for easy placement on relays	10	700-N40
	Blank Identification Tags • contains 10 sheets of blank identification tags for customer specialized printing • Each sheet contains 546 blank tags • Tags are peel-off with sticky backing for easy placement on relays.	10	700-N41

Specifications

Table 101 - General Ratings

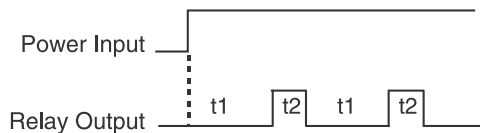
		Cat. No. 700-HV...		
Electrical Ratings				
Pilot Duty Rating ⁽¹⁾		NEMA B300		
Rated Thermal Current (I_{th})		10 A		
Rated Insulation Voltage (U_i)		250V IEC, 300V UL/CSA		
Contacts	Inductive	Make	Break	Hp
		▶] [◀	◀] [▶	
	120V AC	30 A	3 A	1/2 N.O. 1/3 N.C.
	240V AC	15 A	1.5 A	1/2 N.O. 1/3 N.C.
Resistive 28V DC	10 A	10 A	—	
Permissible Coil Voltage Variation		85...110 of Nominal Voltage at 50 Hz 85...110 of Nominal Voltage at 60 Hz 80...110 of Nominal Voltage at DC		
Power Consumption ±10%	AC	24V AC	2 VA	
		120V AC	4 VA	
		240V AC	4 VA	
	DC	1.3 W		
Design Specification/Test Requirements				
Dielectric Withstand Voltage	Pole-to-Pole, same circuit (VRMS)		1000V AC	
	Pole-to-Pole, different circuits (VRMS)		2000V AC	
	Contact-to-Coil (VRMS)		2000V AC	

Table 101 - General Ratings (Continued)

Electrical Life Operations		100,000 minimum
Switching Frequency Operations		1800/h
Coil Voltages		See product selection
Mechanical		
Degree of Protection		Open Type (Guarded Terminal Sockets)
Mechanical Life Operations		10 x 10 ⁶
Switching Frequency Operations		18,000/h
Timing	Duty Cycle	Continuous
Repeat Accuracy	constant voltage and temperature	±2% (Time Delay: 0.1...2 s) ±1% (Time Delay: >2 s)
	variable voltage and temperature)	±10%
Scale Tolerance	High End of Range	+5%
	Low End of Range	-50%
Reset Time		100 ms
Environmental		
Temperature	Operating	-28...+65 °C (50 °C max, 240V AC coil) (-18...+149 °F)(122 °F max, 240V AC coil)
	Storage	-55...+85 °C (-67...+185 °F)
Altitude		2000 m (6560 ft.)
Construction		
Insulating Material		Molded High Dielectric Material
Enclosure		Impact Resistant Dust Cover
Contact Material		Silver Cadmium Oxide
Terminal Markings on Socket		In accordance with EN50 005
Sockets		8-Pin Socket Cat. No. 700-HN100, -HN125
Certifications		CSA Certified, File 223833; UL Recognized, File E3125; Guide NLDX 2; cULus Listed when used with 700-HN100 and 700-HN125 sockets; CE Marked
Standards		EN 61812; CSA 22.2 No. 14; UL 508

(1) See [NEMA Ratings and Test Values on page 5](#).

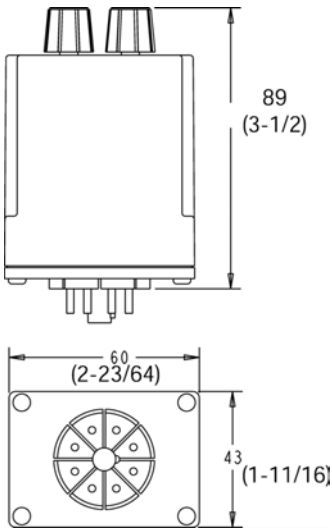
Figure 98 - Timing Diagram- 700-HV Relays



Approximate Dimensions

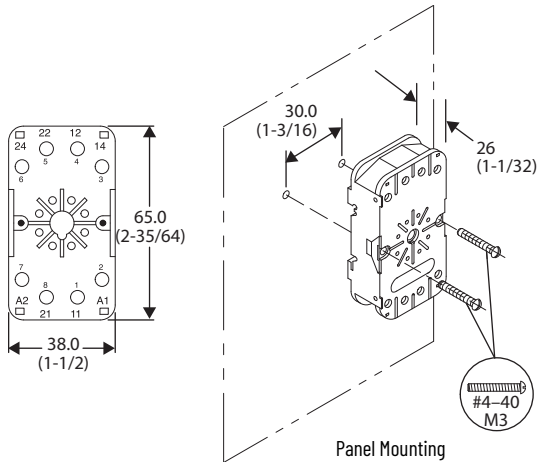
Approximate dimensions are shown in millimeters (inches). Dimensions are not intended for manufacturing purposes.

Figure 99 - 700-HV Timing Relay



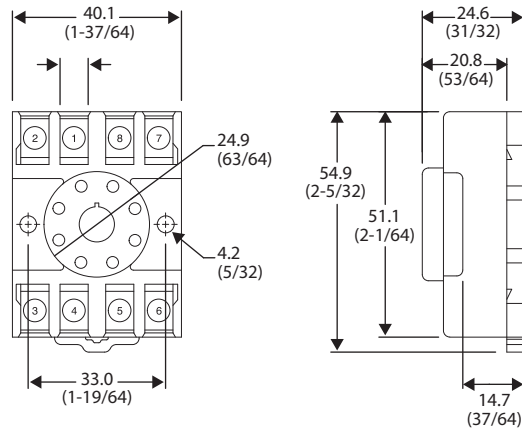
Sockets

Figure 100 - Cat. No. 700-HN100



Wire Size: $2 \times 2.5 \text{ mm}^2$
 Single Wire - Up to #12 AWG
 Double Wire - $2 \times 2.5 \text{ mm}^2$ (#2...14 AWG... #2...20 AWG) (Either Solid or Stranded)
 Strip Length: 9 mm (3/8 in.) - Torque: 0.8 N•m (7 lb•in)

Figure 101 - Cat. No. 700-HN125



Wire Size: $2 \times 2.5 \text{ mm}^2$
 Single Wire - Up to #12 AWG
 Double Wire - $2 \times 2.5 \text{ mm}^2$ (#2...14 AWG... #2...20 AWG) (Either Solid or Stranded)
 Strip Length: 9 mm (3/8 in.) - Torque: 0.8 N•m (7 lb•in)

700-HX Multi-Function Digital Timing Relay

- Digital timing relay with LCD display
- Socket- or panel-mounted (NEMA 4X/IP66)
- 5A, B300, SPDT contact ratings
- 10 Functions or modes
- Environmentally friendly – flash memory, no battery



Multi-Function Digital Timing Relay

Operating Mode	Timing Range	Socket Type	Contact Output	No. of Pins	Input Voltage	Wiring	Cat. No.
A mode: Signal ON-delay 1 A-1 mode: Signal ON-delay 2 A-2 mode: Power ON-delay 1 A-3 mode: Power ON-delay 2 B mode: Repeat Cycle 1 B-1 mode: Repeat Cycle 2 D mode: Signal OFF-delay E mode: One Shot F mode: Cumulative Z mode: On/Off duty adjustable repeat cycle S mode: stop watch toff: Flicker OFF start 1 ton: Flicker ON start 1 toff-1: Flicker OFF start 2 ton-1: Flicker ON start 2	0.000...9.999 s 0.000...99.99 s 0.000...999.9 s 0.000...9999 s 0.000...99 min 59 s 0.000...999.9 min 0.000...9999 min 0.000...99 h 59 min 0.000...999.9 h 0.000...9999 h	700-HN100 700-HN125	SPDT	8	100...240V AC 24V AC 12...24V DC		700-HX86SA17 700-HX86SU24






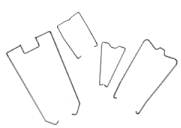

Socket and Retainer Clip Reference

Timer Cat. No.	Socket	Retainer Clip
700-HX	700-HN100	700-HN131
	700-HN108	Not Required ⁽¹⁾
	700-HN125	Not Required ⁽¹⁾

(1) The design of these sockets holds the timing relays securely and does not require retainer clips.

Accessories

Sockets and DIN Rail

	Description		For Use With	Pkg. Qty.	Cat. No.
	Screw Terminal Tube Base Socket • Panel or DIN Rail Mounting • 8-Pin	• Guarded Terminal Construction	700-HA Relays -HX Timing Relays -HT (On-delay) Timing Relays -HRM, -HRC and -HV (Repeat Cycle) Timing Relays	10	700-HN100
		• Open Style Construction • No retainer clip required	DPDT 700-HA Relays -HX Timing Relays -HT (On-delay) Timing Relays -HRM, -HRC and -HV (Repeat Cycle) Timing Relays	10	700-HN125
	DIN (#3) symmetrical hat rail • 35 x 7.5 x 1 m			10	199-DR1
	Specialty Socket • Backwired socket with solder terminals • Order 10 or multiples of 10.	8-pin	700-H timing relays	10	700-HN108
	Frame Adapter • For flush or door mounting of all 700-H and -HX timers.		700-H and -HX timers	1	700-HN130
	Retainer Clip for Cat. Nos. • Secures timer in socket • Not required for installation		700-HN100 and -HN101 Sockets with all 700-H Timing Relays	10	700-HN131
	Protective Cover • Helps prevent tampering of timing and mode settings • Provides a degree of protection against water and dirt from entering the front of the relay		all 700-HR and -HX timing relays	1	700-HN132

Socket and Retainer Clip Reference

Timer Cat. No.	Socket	Retainer Clip
700-HR52, -HRT6, -HRV, -HRQR	700-HN101 ⁽¹⁾	700-HN131
	700-HN126 ⁽¹⁾	Not Required ⁽³⁾
	700-HN129 ⁽¹⁾	Not Applicable


Timer Cat. No.	Socket	Retainer Clip
700-HRS, -HRT4, -HRP, -HRC, -HRM, -HRF, -HRY, -HRQN	700-HN100 ⁽²⁾	700-HN131
	700-HN108 ⁽²⁾	Not Applicable
	700-HN125 ⁽²⁾	Not Required ⁽³⁾

(1) 11 pins.

(2) 8 + pins.

(3) The design of these sockets holds the timing relays securely and does not require retainer clips.

Marking Systems

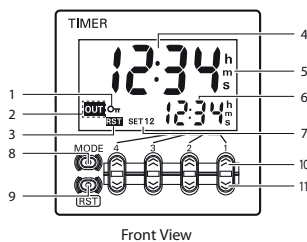
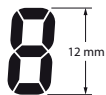
Photo	Description	Pkg. Qty.	Cat. No.
	Pre-printed Identification Tags • Contains 10 sheets of pre-printed and blank tags • Each sheet contains 13 sets of the markings CR...9CR, TR...9TR, M...9M, F, R, 1S, and 117 blank tags • Tags are peel-off with sticky backing for easy placement on relays	10	700-N40
	Blank Identification Tags • contains 10 sheets of blank identification tags for customer specialized printing • Each sheet contains 546 blank tags • Tags are peel-off with sticky backing for easy placement on relays.	10	700-N41

Specifications

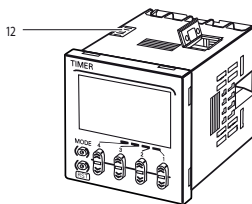
General Timer Functions

- | Display Section | |
|---|--|
| 1. Key Protect Indicator (orange) | |
| 2. Control Output Indicator (orange) | |
| 3. Reset Indicator (orange) | |
| 4. Present Value Display (Main display)
(Character height: 12 mm, red *)
* Characters on models with screw terminals can be switched between red, green, and orange. | |
| 5. Time Unit Indicators
(Color is same as present value display.)
(If the time range is 0 min, 0 h, 0.0 h, or 0 h 0 min, these indicators flash to indicate timing operation.) | |
| 6. Set Value Display (Sub-display)
(Character height: 6 mm, green) | |
| 7. Set Value 1, 2 Indicator (green) | |

Character Size for Present Value Display Character Size for Set Value Display



Front View



- | Operation Key | |
|--|--|
| 8. Mode Key
(Changes modes and setting items) | |
| 9. Reset Key
(Resets present value and output) | |
| 10. Up Keys 1 to 4 | |
| 11. Down Keys 1 to 4 | |

- | Switches | |
|-------------------------------|--|
| 12. Key-protect Switch | |

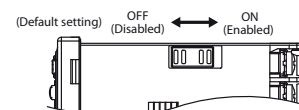


Table 102 - General Ratings

Attribute		700-HX
Electrical Ratings		
Pilot Duty Rating		NEMA B300
Rated supply voltage		100 to 240V AC, 24V AC/12 to 24V DC (50/60Hz) (permissible ripple: 20%(p-p) max)
Operating voltage range		85...110% of rated supply voltage
Power consumption	100...240V AC	4.3VA
	24V AC/12...24V DC	3.4VA/1.7 W
Inrush Current	100...240V AC	3 A
	24V AC/12...24V DC	5 A
Make > { <	120V AC	30 A
	240V AC	15 A
Break < { >	120V AC	3 A
	240V AC	1.5 A
Horsepower	120V AC	1/4 Hp
	240V AC	1/3 Hp
Mechanical		
Mounting Method		Flush mounting, surface mounting, DIN mounting
Display		Seven-segment, negative transmissive LCD; Present value (red, 12 mm high characters); Set value (green, 6 mm high characters)
Digits		Four digits
Timer	Time ranges	0.000...9.999 s, 0.00...99.99 s, 0.0...999.9 s, 0 min 00 s...99 min 59 s, 0.0...999.9 min, 0 h 00 min...99 h 59 min, 0.0 h...999.9 h, 0 h...9999 h
	Timer modes	Elapsed time (Up), remaining time (Down), selectable
	Output modes	A, A-1, A-2, A-3, B, B-1, D, E, F, Z, S, tOFF, tON, tOFF-1, or tON-1
Inputs	Input signals	Start, reset
	Input method	No-voltage input via: NPN transistor or switching of contact
	Start, reset, gate	Minimum input signal width: 1 or 20 ms (selectable)
	Power reset	Minimum power-opening time: 0.5 s (Except for A-3, B-1, and F mode)

Table 102 - General Ratings (Continued)

Attribute	700-HX
Control output	SPDT contact output: 5 A at 250V AC, resistive load (cosine=1) Minimum applied load: 10 mA at 5 V DC (failure level: P, reference value)
External Power Supply	No
Key Protect	Yes
Memory Backup	EEP-ROM (overwritten 100 000 times min), which can store data for 10 years min
Accuracy of Operating Time and Setting Error ⁽¹⁾	Power-ON start: $\pm 0.01\%$ ± 50 ms max to be rated against set value Signal start: $\pm 0.005\%$ ± 30 ms max to be rated against set value Signal start at transistor output model: $\pm 0.005\%$ ± 3 ms max ⁽²⁾ If the set value is within the sensor waiting time (250 ms max)

(1) The values are based on the set value.

(2) The value is applied for a minimum pulse width of 1 ms.

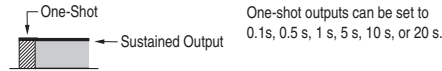
Table 103 - Environmental and Construction Ratings

Attribute	700-HX	
Environmental		
Installation environment	Setup category II, pollution degree 2 (as per IEC61010-1)	
Ambient temperature	-10...+55 °C (14...141 °F), Avoid freezing or condensation	
Ambient humidity	25...85 %	
Storage temperature	-25...+65 °C (-13...+149 °F), Avoid freezing or condensation	
Altitude, max	2,000 m	
Characteristics ⁽¹⁾		
Insulation Resistance	100 m Ω min (at 500V DC)	
Dielectric Strength	2000V AC, 50/60Hz for 1 min between current-carrying terminals and non-current-carrying metal parts (1000V AC for 24V AC/12 to 24V DC type), 1000 24V AC, 50/60 Hz for 1 min between non-continuous contacts	
Noise Immunity	± 1.5 kV (between power terminals) for 100 to 240 VAC, ± 480 V for 24VAC/12 to 24VDC, and ± 600 V (between input terminals), square-wave noise by noise simulator (pulse width: 100 ns/1 μ s, 1-ns rise)	
Static Immunity	± 8 kV (malfunction), ± 15 kV (destruction)	
Vibration Resistance	Malfunction	
Shock Resistance	Malfunction	
Life Expectancy	Mechanical	10 million operations min (under no load at 18 000 operation/h)
	Electrical	100 000 operations min (5 A at 250V AC, resistive load at 1800 operation/h)
EMC	(EMI)	EN61812-1
	Emission Enclosure:	EN55011 Group1 class A
	Emission AC mains:	EN55011 Group1 class A
	(EMS)	EN61812-1
	Immunity ESD:	EN61000-4-2: 4 kV contact discharge (level2) 8 kV air discharge (level3)
	Immunity RF-interference:	EN61000-4-3: 10V/m
Enclosure Ratings	Panel surface: IP66 and NEMA Type 4 (indoors) ⁽²⁾	
Weight	Approx. 100 g	
Certifications	CE Certified; cURus (File No. E14843, Guide NRNTZ/NRNT8), C-Tick Marked	
Standards	EN61010-1, EN 61326, VDE0106/P 100, CSA C22.2 No. 14, UL 508	

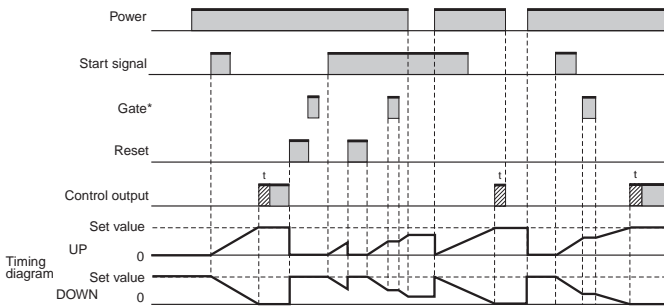
(1) More information in the 700-HX User Manual, publication [700-UM002](#).

(2) An attached waterproof packing is necessary to ensure IP66 waterproofing between the 700-HX and installation pan.

Timing Charts

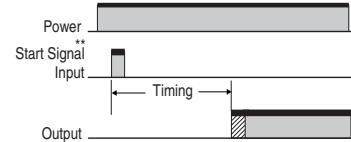


Output Mode A Mode: Signal ON-Delay (Timer resets when power comes ON.)



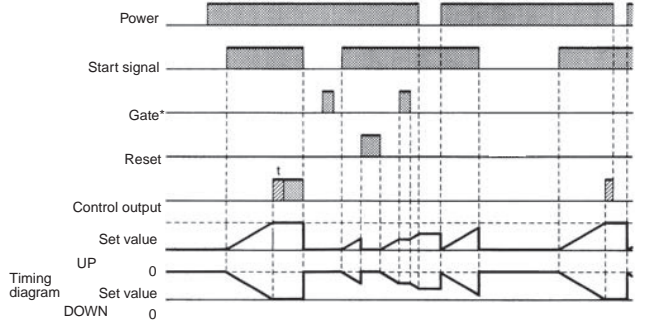
Timing starts when the start signal goes ON. While the start signal is ON, the timer starts when power comes ON or when the reset input goes OFF. The control output is controlled using a sustained or one-shot time period.

Basic Operation



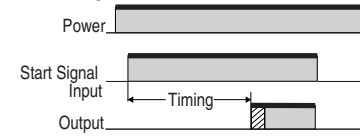
*Output is instantaneous when setting is 0.
** Start signal input is enabled during timing.

Output Mode A-1: Signal ON-Delay 2 (Timer resets when power comes ON.)



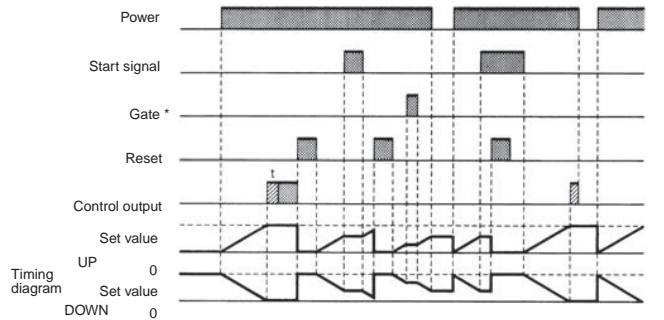
Timing starts when the reset input goes ON and is reset when the start signal goes OFF. While the start signal is ON, the timer starts when the power comes ON or when the reset input goes OFF. The control output is controlled using a sustained or one-shot time period.

Basic Operation



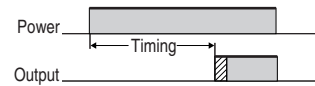
*Output is instantaneous when setting is 0.

Output Mode A-2: Power ON Delay 1 (Timer resets when power comes ON)



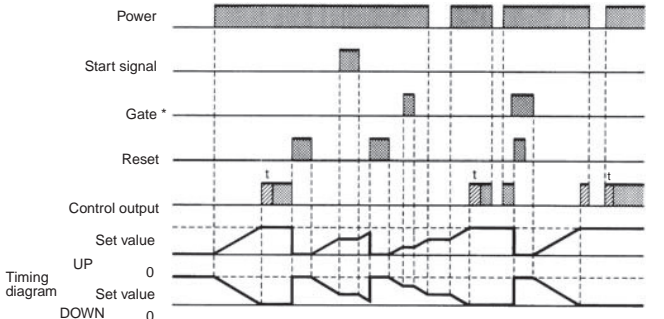
Timing starts when the reset input goes OFF. The start signal disables the timing function (i.e., same function as the gate input). The control output is controlled using a sustained or one-shot time period.

Basic Operation



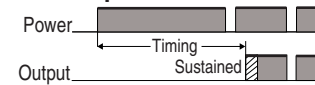
*Output is instantaneous when setting is 0.

Output Mode A-3 Power ON Delay 2 (Timer does not reset when power comes ON)



Timing starts when the reset input goes OFF. The start signal disables the timing function (i.e., same function as the gate input). The control output is controlled using a sustained or one-shot time period.

Basic Operation

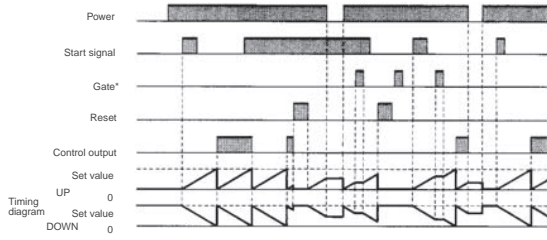


*Output is instantaneous when setting is 0.

* Gate not included on any mode of this relay.

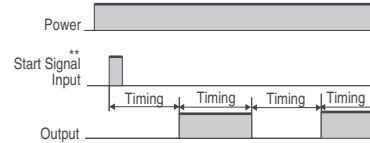
Output Mode B: Repeat Cycle (Timer resets when power comes ON.)

Sustained Output



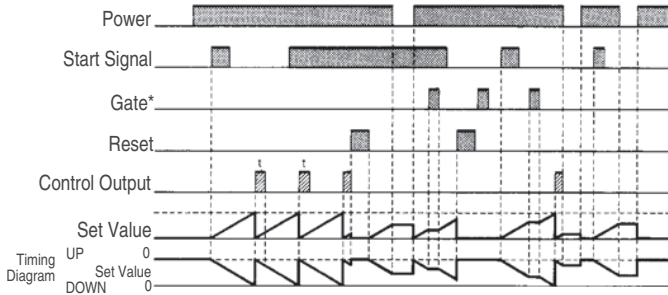
Timing starts when the start signal goes ON. The status of the control output is reversed when time is up (OFF at start). While the start signal is ON, the timer starts when the power comes ON or when the reset input goes OFF.

Basic Operation



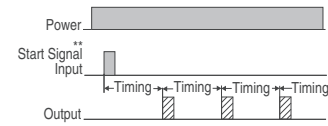
* Normal output operation will not be possible if the set time is too short.
Set the value to at least 100 ms (contact output type).
** Start signal input is disabled during timing.

One-Shot Output



Timing starts when the start signal goes ON. The control output is turned ON when time is up. While the start signal is ON, the timer starts when the power comes ON or when the reset input goes OFF.

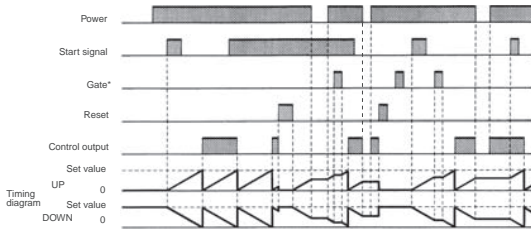
Basic Operation



* Normal output operation will not be possible if the set time is too short.
Set the value to at least 100 ms (contact output type).
** Start signal input is disabled during timing.

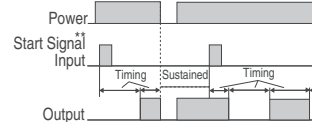
Output Mode B-1: Repeat Cycle 2 (Timer does not reset when power comes ON)

Sustained Output



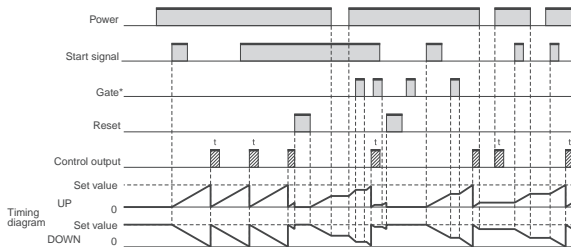
Timing starts when the start signal goes ON. The status of the control output is reversed when time is up (OFF at the start). While the start signal is ON, the timer starts when the power comes ON or when the reset input goes OFF.

Basic Operation



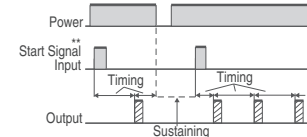
* Normal output operation will not be possible if the set time is too short.
Set the value to at least 100 ms (contact output type).
** Start signal input is disabled during timing.

One-Shot Output



Timing starts when the start signal goes ON. The control output comes ON when time is up. While the start signal is ON, the timer starts when the power comes ON or when the reset input goes OFF.

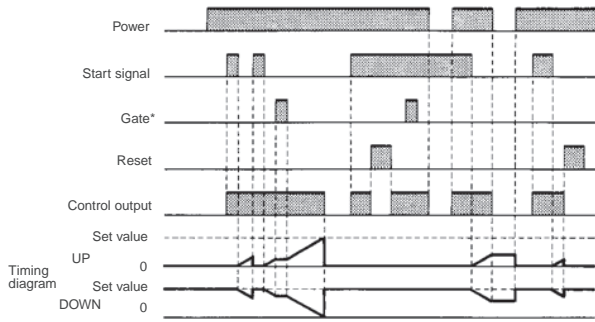
Basic Operation



* Normal outout operation will not be possible if the set time is too short.
Set the value to at least 100 ms (contact output type).
** Start signal input is disabled during timing.

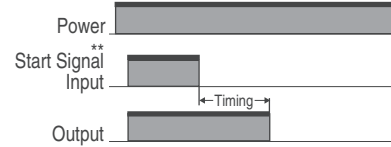
* Gate not included on any mode of this relay.

Output Mode D: Signal OFF-Delay (Timer resets when power comes ON.)



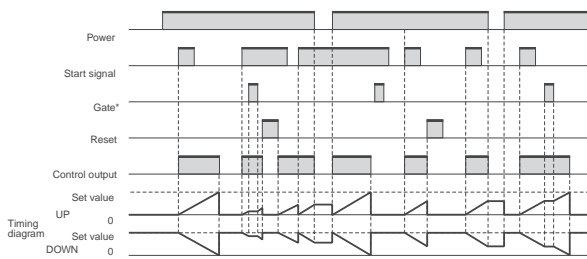
The control output is ON when the start signal is ON (except when the power is OFF or the reset is ON).
The timer is reset when the time is up.

Basic Operation



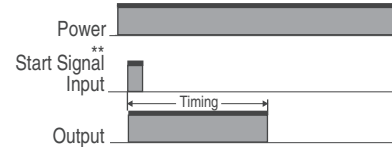
* Output functions only during start signal input when setting is 0.
** Start signal input is enabled during timing.

Output Mode E: Interval (Timer resets when power comes ON.)



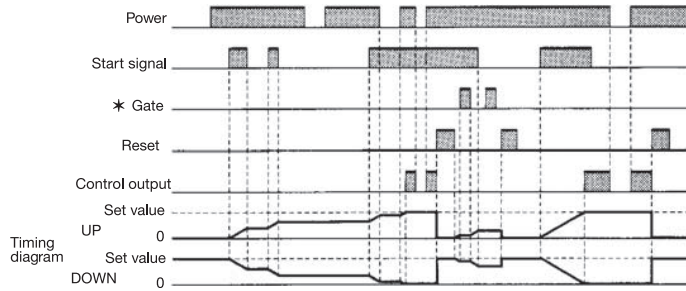
Timing starts when the start signal comes ON. The control output is reset when time is up. While the start signal is ON, the timer starts when power comes ON or when the reset input goes OFF.

Basic Operation



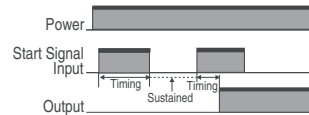
* Output is disabled when the setting is 0.
** Start signal input is enabled during timing.

Output Mode F: Cumulative (Timer does not reset when power comes ON)



Start signal enables timing (timing is stopped when the start signal is OFF or when the power is OFF). A sustained control output is used.

Basic Operation



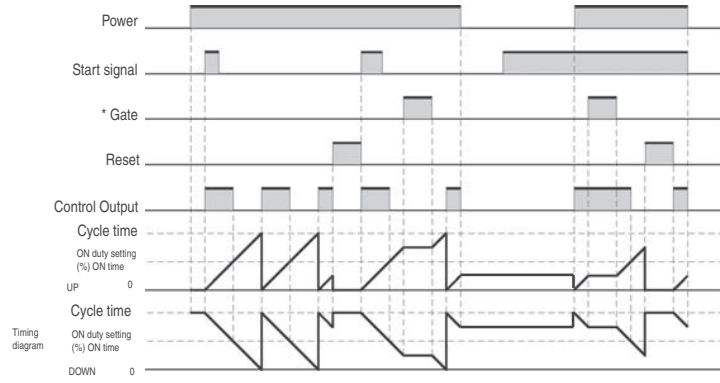
*Output is instantaneous when setting is 0.

★ Gate not included on any mode of this relay.

Z Mode

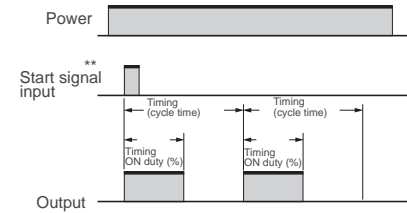
Output quantity can be adjusted by changing the cycle time set in the adjustment level to 1 and by changing the ON duty (%) set value. The set value shows the ON duty (%) and can be set to a value between 0 and 100 (%). When the cycle time is 0, the output will always be OFF. When the cycle time is not 0 and when ON duty has been set to 0 (%), the output will always be OFF. When ON duty has been set to 100 (%), the output will always be ON.

Z mode: ON/OFF-duty Adjustable Repeat Cycle



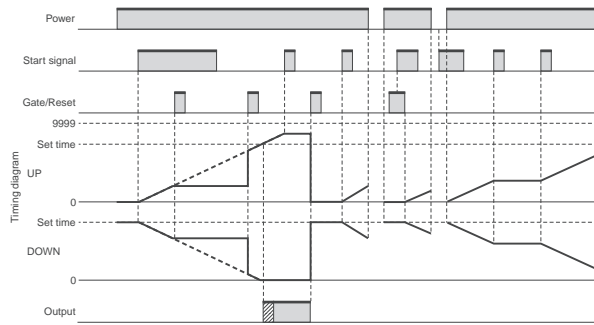
Timing starts when the start signal goes ON. The status of the control output is reversed when time is up (ON at start). While the start signal is ON, the timer starts when power comes ON or when the reset input goes OFF.

Basic Operation



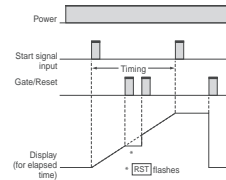
* Normal output operation will not be possible if the set time is too short. Set the value to at least 100 ms (contact output type).
 ** Start signal input is enabled during timing.

Output Mode S: Stop Watch (Timer resets when power comes ON)



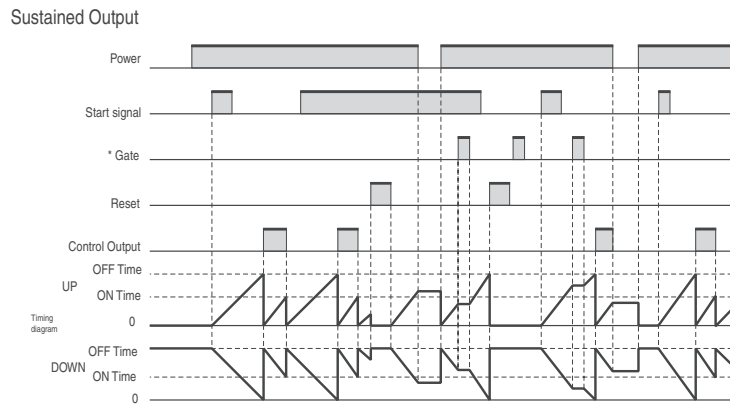
The signal starts and stops timing. The display is held and timing is continued if the reset or gate input is received during timing operation. The timer resets if the reset or gate input is received when the timing operation is stopped.

Basic Operation



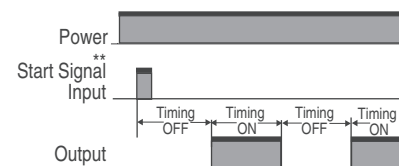
Note: Output is instantaneous when setting is 0.

Output Mode T OFF: Twin Timer OFF start



Timing starts when the start signal goes ON. The status of the control output is reversed when time is up (OFF at start). While the start signal is ON, the timer starts when power comes ON or when the reset input goes OFF.

Basic Operation

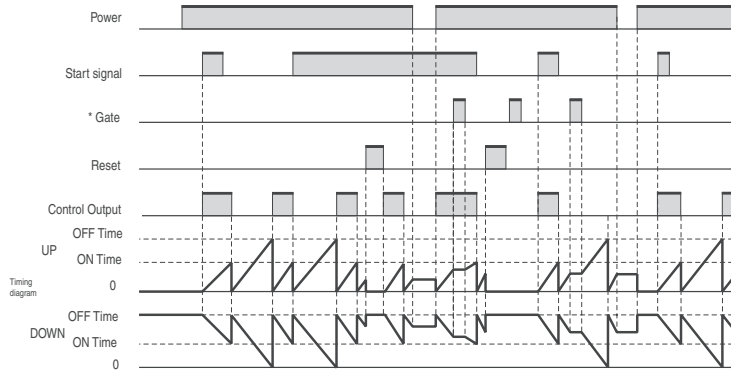


* Normal output operation will not be possible if the ON/OFF set time is too short. Set the value to at least 100 ms (contact output type).
 ** Start signal input is disabled during timing.

* Gate not included on any mode of this Relay.

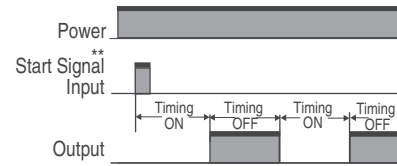
Output Mode T ON: Twin Timer ON start

Sustained Output



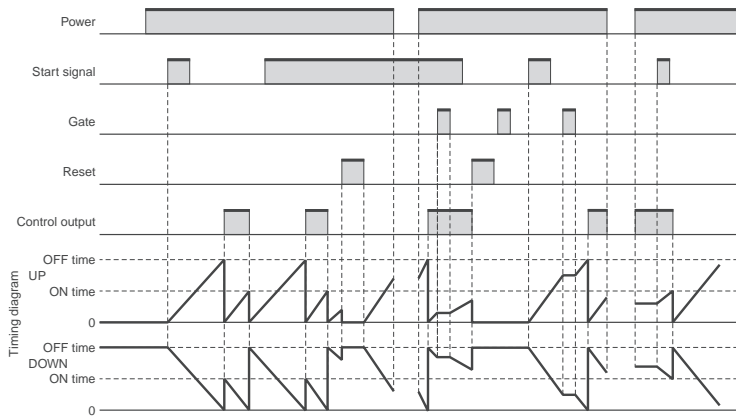
Timing starts when the start signal goes ON. The status of the control output is reversed when time is up (ON at start). While the start signal is ON, the timer starts when power comes ON or when the reset input goes OFF.

Basic Operation



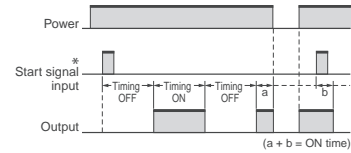
* Normal output operation will not be possible if the ON/OFF set time is too short. Set the value to at least 100 ms (contact output type).
** Start signal input is disabled during timing.

Output Mode TOFF-1: Flicker OFF start 2 (Timer does not reset when power comes ON)



Timing starts when the start signal goes ON. The status of the control output is reversed when time is up (OFF at start). While the start signal is ON, the timer starts when the power comes ON or when the reset input goes OFF.

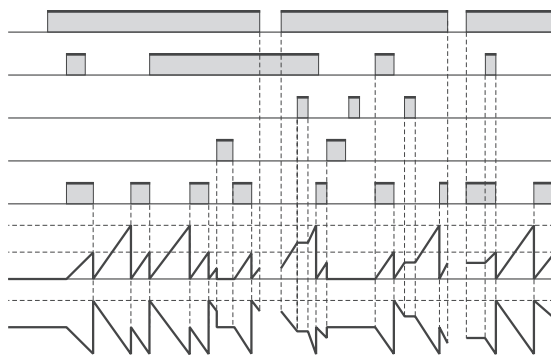
Basic Operation



* Start signal input is disabled during timing.

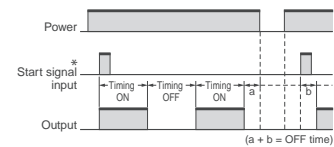
Note: Normal output operation will not be possible if the set time is too short. Set the value to at least 100 ms (contact output type).

Output Mode TON-1: Flicker ON start 2 (Timer does not reset when power comes ON)



Timing starts when the start signal goes ON. The status of the control output is reversed when time is up (ON at start). While the start signal is ON, the timer starts when the power comes ON or when the reset input goes OFF.

Basic Operation



* Start signal input is disabled during timing.

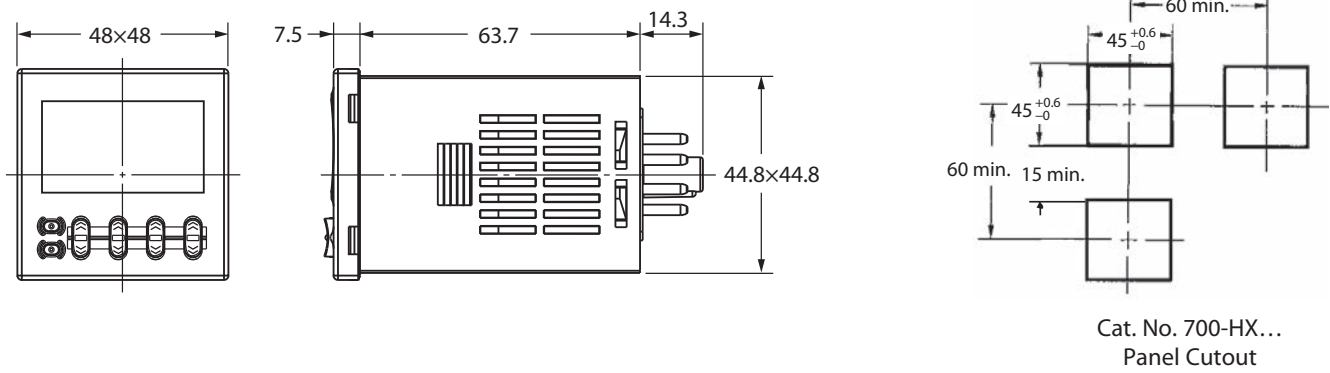
Note: Normal output operation will not be possible if the set time is too short.

★ Gate not included on any mode of this Relay.




Approximate Dimensions



Approximate dimensions are shown in millimeters (inches). Dimensions are not intended for manufacturing purposes.

Figure 102 - 700-HX Multi-function Digital Timing Relays



Product Overview

			
Bulletin No.	700-P	700S-P	700-N
Type	Heavy-duty control relay	Heavy-duty control relay	Industrial Relay
Features	<ul style="list-style-type: none"> • Convertible contacts • Up to 600V AC & DC • Very long life • Timer & latch options • Mechanically linked 	<ul style="list-style-type: none"> • Convertible contacts • Up to 600V AC & DC • Very long life • Timer & latch options • Mechanically linked 	<ul style="list-style-type: none"> • Contact cartridges convertible from N.O. to N.C. and vice versa • NEMA A300 AC • 24...250V AC coils • Pneumatic timing unit • Solid-state timing unit • Overlap contacts • Logic reed contacts
Contact Form	2...12 poles, double break	2...12 poles, double break	2 or 4 poles
Contact Type	Bifurcated double break	Bifurcated double break	–
Contact Material	Bifurcated silver nickel	Bifurcated silver nickel	Silver
Electrical			
Max. Current AC Resistive	10 A	10 A	10 A
Min. load	10V, 50 mA 1 mA, 5V with 700-CPR	10V, 50 mA 1 mA, 5V with 700-CPR	–
Coil Voltage	24...600V AC 6...600V DC	24...600V AC 6...600V DC	–
Coil Voltage Pickup	85...110% AC coils, 80...110% DC coils	85...110% AC coils, 80...110% DC coils	–
Dielectric Withstand	2640V	2640V	–
Electric Service Life (cycles)	10 million at 10 A 120V AC	10 million at 10 A 120V AC	–
Certifications	cULus, CE	cULus, CE	UL, CSA, CE
Sockets	DIN Rail, relay rail, or panel mount	DIN Rail, relay rail, or panel mount	–
Product Selection	154	167	172

		
Bulletin No.	700-R	700-RTC
Type	Sealed Switch	Solid-state Timing Relay
Features	<ul style="list-style-type: none"> • Hazardous location ratings • Long life in dirty environment • Timer and latch options • Switch 600V AC, 300V DC 	<ul style="list-style-type: none"> • Timed and instantaneous contacts. • Sealed contacts for harsh environments and hazardous locations.
Contact Form	2...8 Poles	—
Contact Type	Sealed Switch	—
Contact Material	Sealed Switch	—
Electrical		—
Max. Current AC Resistive	5 A	—
Min. load	1 mA, 5V	—
Coil Voltage	24...240V AC 24...250V DC	—
Coil Voltage Pickup	85...110% AC Coils 80...110% DC Coils	—
Dielectric Withstand	2640V	—
Electric Service Life (cycles)	1.5 million at 5 A 120V AC	—
Certifications	UL, CSA, CE	—
Sockets	Panel or rail mount	—
Control Outputs: Time Limit Instantaneous	—	Four output contacts
Timing Operation Modes	—	On-Delay Off-Delay
Time Range	—	0.05 s...64 min
Supply Voltage	—	24V AC 110...120V AC 220...240V AC 24V DC 120V DC 240V DC
Product Selection	178	183

700-P Industrial Relays

700-P – Direct Drive Convertible Contact Cartridge Relays

- NEMA and IEC ratings
- 600V maximum AC/DC
- Accessories for field installation: contact cartridges, adder decks, time delay, latching, surge suppressors, mounting strip
- Contact Ratings: (10 A) 700-CP1, (20 A) 700-CPM, (35 A) 700-CPH, (Low Power) 700-CPR
- For machine tool and other heavy-duty applications
- Can accommodate ring tongue terminals
- Integral DIN Rail mount on AC relays
- Finger-safe protection standard
- Factory supplied standard at 120V AC and 24V DC - user configurable for field assembly
- Blank relays are available in all coil voltages for field custom configuration
- Contact cartridge is convertible from N.O. to N.C. by simply turning cartridge over.

The 700/700DC-P family of Direct Drive Industrial Relays offers switching solutions ranging from 200 mA in low-energy circuits to 35 A in heavy-duty circuits. All of the contacts can easily be changed from the standard N.O. to N.C. configuration. The relays can be accessorized to meet the application needs with the use of time delayed contacts, mechanical latches and NEMA enclosures. All devices are available in the most popular AC and DC control voltages. Combining different cartridges into one relay can yield a custom-tailored application solution. Relays are available without contact cartridges in all of the available AC and DC coil voltages for maximum flexibility.

700/700DC-P relays use standard (10 A) contact cartridges with a double-break and bifurcated design. Bifurcation provides excellent contact reliability and low-contact bounce, while the double-break contact design reduces the possibility of contacts welding and enhances the relay's ability to break DC circuits. These relays can be configured with a maximum of 12 contacts (only 8 may be N.C.).

A Modular Approach to Control Circuit Solutions


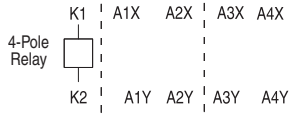
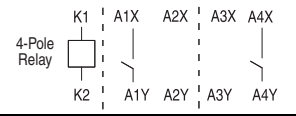
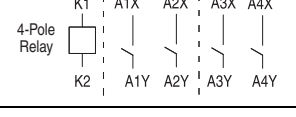
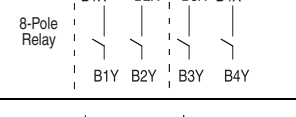
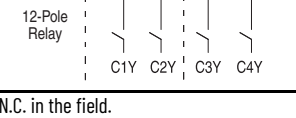
The 700-P AC control relay is factory assembled with standard 10 A contact cartridges, with all contacts as N.O. in either 2-, 4-, 8-, or 12-pole configurations with a 120V operating coil. Four-pole relays are also available at 240 and 480V AC and can have up to eight contacts added by using adder decks. The 700DC-P DC control relay is factory assembled with a standard 10 A contact cartridges, with all contacts as N.O. in either 4 or 8 poles with a 24V operating coil. The 4-pole version is also available with a 120V DC operating coil.

For control relays that require different contact ratings or control voltages we offer a modular design that are easily field configurable. A base blank relay (either AC or DC control), a variety of contact kits, adder decks, and operating coils can be used to make an infinite number of custom control relay solutions.

- Master Control 700-PMCKIT master control cartridges provide (20 A) switching capability with large single-contact pads on each side of the spanner for twice the current rating to control heavy loads and provide for master control of a system. The cartridge also has the same double-break design as the standard 700-P relay contact cartridge. Relays can be configured with up to a maximum of 12 contacts (only 8 may be N.C.). Time delay and latching attachments are compatible with master cartridges.
- Heavy Duty Control 700-PHDKIT contact cartridges provide (35 A) switching capability through tandem contact cartridges. A jumper allows two (20 A) master contact cartridges to be connected in parallel. A maximum of six poles can be configured in a relay, only four of which can be normally closed. Time delay and latch attachments are available.
- Low Energy Control Logic Reed 700-PLRKIT contact cartridges provide switching to 200 mA @ 30V DC. These contacts are matched with standard control (10 A) contact cartridges for low energy switching applications.
- Overlapping Contact 700-POLKIT contact cartridges provide (10 A) switching capabilities with the same rating as the standard contact. These cartridge used in pairs operate with the N.O. contact closing before the N.C. contact opens on pickup and vice versa on the dropout.


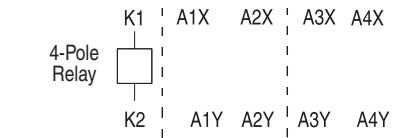
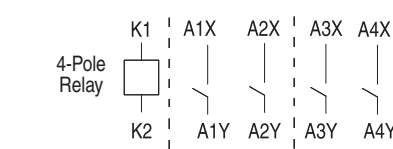
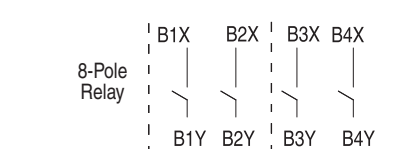
Direct Drive Convertible Contact Cartridge Relays

AC-Operated Relays - In-stock Contact Configurations

Photo	Contacts N.O. (1)	Contact Arrangement and Markings	Open Type, DIN Rail, or Relay Rail Mount (700-MP)		
			120V AC	240V AC	480V AC
	0		700-P000A1	—	—
	2		700-P200A1	—	—
	4		700-P400A1	700-P400A2	700-P400A4
	8		700-P800A1	—	—
	12		700-P1200A1	—	—

(1) Factory-assembled N.O. contacts can be easily converted to N.C. in the field.

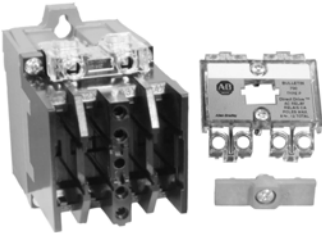
DC-Operated Relays - In-stock Contact Configurations

Photo	Contacts N.O. (2)	Contact Arrangement and Markings	Open Type Relay Rail Mount (1)	
			24V DC	120V DC
			Cat. No.	Cat. No.
	0		700DC-P000Z24	—
	4		700DC-P400Z24	700DC-P400Z1
	8		700DC-P800Z24	—

(1) For DIN Rail mounting, order Cat. No. 700-DRA.

(2) Factory-assembled N.O. contacts can be easily to N.C. in the field.

Base Blank Relay - Factory Assembled

Photo	Type of Control Circuit	Cat. No.
	AC	700-P000⊗
	DC	700DC-P000⊗

⊗ AC Coil Voltage Code

The Cat. No. as listed is incomplete. Select a voltage suffix code from the table below to complete the Cat. No. Example: Cat. No. 700-P000⊗ becomes Cat. No. 700-P000A1.

Hz	24	110	115-120	200-208	230-240	277	460-480	575-600
50	—	A1	—	—	—	—	—	—
60	A24	—	A1	A20	A2	A27	A4	A6

⊗ DC Coil Voltage Code

The Cat. No. as listed is incomplete. Select a voltage suffix code from the table below to complete the Cat. No. Example: Cat. No. 700DC-P000⊗ becomes Cat. No. 700DC-P000A1.

24	48	72	115-125	230-250	575-600
Z24	Z48	Z72	Z1	Z2	Z6

Master (20 A) and Heavy-duty (35 A) Contact Cartridge Options

Follow this process to order a relay that utilizes: 20 A master contact cartridges or 35 A heavy-duty contact cartridges

Base Blank Relay	+	Cartridge Kit	+	Adder Decks	+	Coil
-------------------------	---	----------------------	---	--------------------	---	-------------

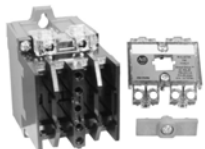


	Type of Control Circuit	Cat. No.
	AC	700-P000A1
	DC	700DC-P000Z24

Photo	Description	Contents	Continuous Carrying Current [A]	Cat. No.
	Master Contact Cartridge <ul style="list-style-type: none"> AC Rating Twice NEMA A600 DC Rating NEMA N150 P600 	4 Master Cartridges (Cat. No. 700-CPM)	20	700-PMCKIT
	Heavy-duty Contact Kit	4 Master Cartridges and two sets of jumper terminals, rating label (makes two 35 A poles)	35	700-PHDKIT

Adder Decks—Use when you have four circuits or more than two 35 A circuits in the relay

	Device Description	Adder Decks Required Cat. No.	Additional Cartridge Kits Required
	8-Pole Device	700-PB00	1 additional kit
	12-Pole Device	700-PB00 700-PC00 (Qty 1 of each)	2 additional kits

EXAMPLE Heavy Duty circuit (35 A) application that requires 4 circuits and 240 AC control circuit:

- Base Unit: Cat. No. 700-P000A1
- Cartridge Kits: Cat. No. 700-PHDKIT - Qty 2 (Each kit makes two circuits)
- Adder Deck: Cat. No. 700-PB00
- Coil: Cat. No. PA254



If required, see [Operating Coils](#) for coil selection.

Logic Reed and Overlapping Contact Cartridge Option

Follow this process to order a relay that utilizes: low energy contact cartridges or overlapping late make or late break cartridges

Base Blank Relay	+	Cartridge Kit	+	Adder Decks	+	Coil
-------------------------	---	----------------------	---	--------------------	---	-------------

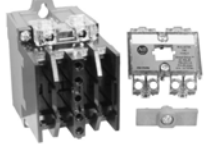


	Type of Control Circuit	Cat. No.
	AC	700-P000A1
	DC	700DC-P000Z24

Photo	Description	Contents	Continuous Carrying Current [A]	Cat. No.
	Logic Reed Cartridge for Low-energy Circuits <ul style="list-style-type: none"> 150V AC 500 mA 25 VA Max. 30V DC 200 mA 6W Max. 	2 Logic Reed Cartridges (Cat. No. 700-CPR)	500 mA 150V AC 200 mA 30V DC	700-PLRKIT
		2 Standard Cartridges (Cat. No. 700-CP1)	10	
	Overlap Contact Cartridges <ul style="list-style-type: none"> Overlapping Used in pairs. N.O. contact closes before N.C. contact opens on pick-up and vice versa on drop-out. 	4 Overlapping Cartridges (Cat. No. 700-CP11Z)	10	700-POLKIT

Adder Decks—Use when you have four circuits or more than two 35 A circuits in the relay

	Device Description	Adder Decks Required Cat. No.	Additional Cartridge Kits Required
	8-Pole Device	700-PB00	1 additional kit
12-Pole Device	700-PB00 700-PC00 (Qty 1 of each)	2 additional kits	

EXAMPLE Logic Reed and Overlapping Contact Cartridge Option:




- Low Voltage Circuit 24V DC less than 200 mA
- Base Unit: Cat. No. 700-P000A1
- Cartridge Kits: Cat. No. 700-PLRKIT - Qty 1
- Coil: Cat. No. PA254





If required, see [Operating Coils](#) for coil selection.

Accessories

Adder Decks












Photo	Description	No. of N.O. Contacts	Continuous Carrying Current [A]	Arrangement	Cat. No.
	Second Deck (0-pole)	0	–	B1X B2X B3X B4X	700-PB00
	Second Deck (4-pole)	4	10	B1Y B2Y B3Y B4Y 	700-PB40
	Third Deck (0-pole)	0	0	C1X C2X C3X C4X	700-PC00
	Third Deck (4-pole)	4	10	C1Y C2Y C3Y C4Y 	700-PC40

Operating Coils

	Coil Volts ⁽¹⁾	Bulletin 700-P, 2...12-pole, AC control		Bulletin 700-PLL-PKLL AC Mechanical Latch Attachment			Bulletin 700DC-P 2...12-pole, DC control
		60 Hz	50 Hz	60 Hz	50 Hz	DC	–
 Bulletin 700-P Operating Coil	24	PA013	PA407	PL013	PL407	PM714	PD714
	48	–	–	–	–	PM724	PD724
	72	–	–	–	–	PM730	PD730
	110 ⁽²⁾	–	PA236	–	PL236	–	PD733 (100...110)
	115...120 ⁽³⁾	PA236	–	PL236	–	–	–
	–	PA322	–	PL322	–	–	–
	115...125	–	–	–	–	PM735	PD735
	120§	PA322	–	PL322	–	–	–
 Bulletin 700-PL Unlatch Coil and Magnet Assembly	130...140	–	–	–	–	–	–
	200...208	PA249	–	–	–	–	–
	220...230	PA251	PA339	–	–	–	–
	230...240	PA254	PA342	PL254	–	–	–
	230...250	–	–	–	–	PM748	PD748
	277	PA260	–	–	–	–	–
	380	–	PA354	–	–	–	–
	415	–	PA357	–	–	–	–
	440...460	–	PA360	–	–	–	–
	460...480	PA273	–	–	–	–	–
500	–	–	–	–	–	–	
575...600	PA278	–	–	–	–	PD758	

(1) Coils for AC relays cannot be used in DC relays and vice versa.
 (2) This coil is optimized for 115...120V, 60 Hz applications and operates satisfactorily at 110V, 50 Hz.
 (3) This coil is optimized for 110...115V, 50 Hz applications and operates satisfactorily at 120V, 60 Hz.

Contact Cartridges (Convertible from N.O. to N.C. and N.C. to N.O.)

	Description	Continuous Carrying Current [A]	Arrangement	Pkg. Quantity	Cat. No.
	Standard Contact Cartridge • AC Rating NEMA A600 • DC Rating NEMA P600	10	 or 	1	700-CP1
	Overlap Contact Cartridges • Overlapping • Used in pairs. N.O. contact closes before N.C. contact opens on pick-up and vice versa on drop-out. ⁽¹⁾	AC Rating NEMA A600 DC Rating NEMA P150 125V DC, 138 VA Make and Break	10 5	 or 	2
	Master Contact Cartridge • AC Rating Twice NEMA A600 • DC Rating NEMA N150 P600	20	 or 	1	700-CPM
	Logic Reed Cartridge for Low-energy Circuits • 150V AC 500 mA 25 VA Max. • 30V DC 200 mA • 6W Max. ⁽²⁾	Maximum 150V AC	 or 	1	700-CPR
		Maximum 30V DC			

(1) Not Direct Drive.
 (2) The 700-CPR Logic Reed cartridge must be installed only in the 2nd deck (B1X - B4X, B1Y - B4Y position) or 3rd deck (C1X - C4X, C1Y - C4Y position) of the Bulletin 700 Type P relay. It is not recommended that the 700-CPR cartridge be installed in the single deck (A1X - A4X, A1Y - A4Y position) because this may lead to improper operation.

Electrically Held Relays – Typical Wiring Diagrams

Figure 103 - Standard Cartridge

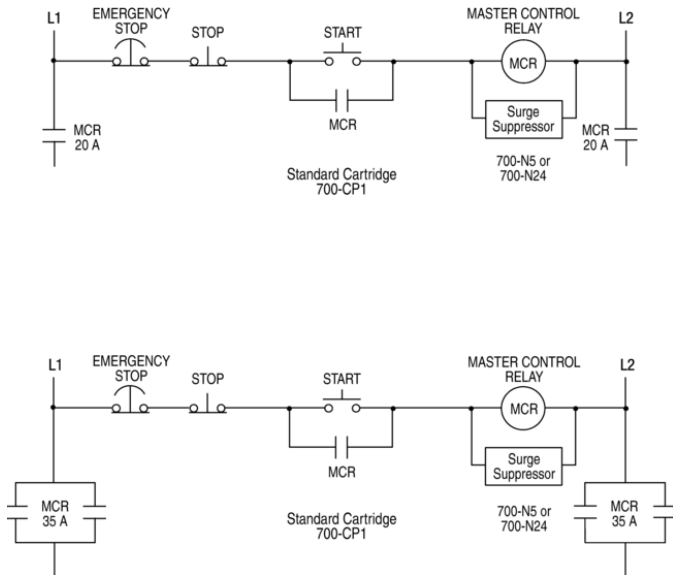
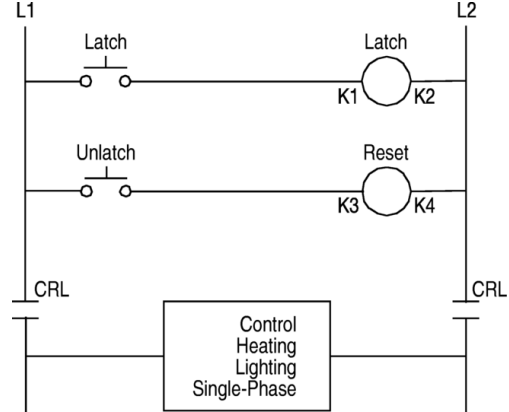



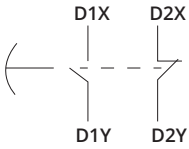
Figure 104 - Control Heating Lighting, Single Phase



Pneumatic Time-Delay Unit

- Timing Range – 0.1...60 s
- 0, 2, or 4 instantaneous contacts
- Two timed contacts – both ON Delay or both OFF Delay
- Convertible from ON Delay to OFF Delay and vice versa
- Standard contact cartridges rated NEMA A600 (AC) and P600 (DC)
- Master contact cartridges rated 2X NEMA A600 (AC) and N150 P600 (DC)


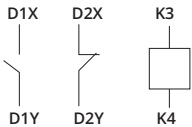
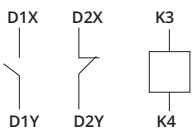
Open Type Without Enclosure⁽¹⁾

	Operating Mode	No. of Timed Contacts ⁽²⁾		Continuous Carrying Current [A]	Arrangement	Timing Range	Cat. No.
		N.O.	N.C.				
	On-delay	1	1	10		0.1...60 s	700-PT
	Off-delay			20			700-PKT

(1) Mounts on 4-pole Bulletin 700-P or -PK relay or 2-pole Bulletin 700-PH relay.

(2) In addition to instantaneous cartridges on the relay

Mechanical Latch Units

	Description	Arrangement	Continuous Carrying Current [A]	Cat. No.
	AC-Operated Latch Units		No cartridge	700-PLL⊗
			10	700-PLL1⊗
			20	700-PKLL1⊗
	DC-Operated Latch Units		No cartridge	700DC-PLL⊗
			10	700DC-PLL1⊗
			20	700DC-PKLL1⊗

⊗ AC Coil Voltage Code

The Cat. No. as listed is incomplete. Select a voltage suffix code from the table below to complete the Cat. No. Example: Cat. No. 700-PLL⊗ becomes Cat. No. 700-PLL A1.

Hz	24	110	110-115	115-120	120	230-240
50	B24	A1 ⁽¹⁾	B1 ⁽²⁾	—	—	—
60	A24	—	—	A1 ⁽¹⁾	B1 ⁽²⁾	A2

(1) Optimized for 115...120V, 60 Hz. Operates satisfactorily at 110V, 50 Hz.

(2) Optimized for 110...115V, 50 Hz. Operates satisfactorily at 120V, 60 Hz.




⊗ DC Coil Voltage Code

The Cat. No. as listed is incomplete. Select a voltage suffix code from the table below to complete the Cat. No. Example: Cat. No. 700DC-PLL⊗ becomes Cat. No. 700DC-PLL Z24.


	24	48	72	115-125	230-250	575-600
DC	Z24	Z48	Z72	Z1	Z2	Z6

Accessories



Mounting Accessories

	Description	Relays per Strip	Pkg. Qty.	Cat. No.
	Relay Rail <ul style="list-style-type: none"> • Simplifies panel layout • Indexed strips are easily cut to the required length and bolted, riveted, or spot-welded in place. • Relays are installed adjacent to one another on the mounting strip with the captive mounting screws provided • Rows of relays on Relay Rail form their own wiring trough • Can be used with the following relays: <ul style="list-style-type: none"> - 700P - 700DC-P - 700S-P - 700N - 700-R - 700-RTC 	4	5	700-MP4
		8	5	700-MP8
		12	5	700-MP12
		16	5	700-MP16
	DIN (#3) symmetrical hat rail <ul style="list-style-type: none"> • 35 x 7.5 x 1 m 		10	199-DR1
	DIN Rail Adapter <ul style="list-style-type: none"> • Can be used with the following relays: <ul style="list-style-type: none"> - 700P - 700DC-P - 700S-P - 700N - 700-R - 700-RTC 		1	700-DRA






Enclosures

	Description	Cat. No.
	Type 1 Enclosure <ul style="list-style-type: none"> • for all 700-P relays except: <ul style="list-style-type: none"> - 10- and 12-pole DC relays - 6-pole DC 700-PH relays 	700-N31
	Type 4/4X Enclosure <ul style="list-style-type: none"> • For 2- and 4-pole Bulletin 700-P, -N, and -R relays and 2-pole heavy duty relays 	700-N39
	Type 7 & 9 Enclosure <ul style="list-style-type: none"> • For 2- and 4-pole Bulletin 700-P, -N, and -R relays and 2-pole heavy duty relays • 1 conduit hub; top and bottom 	700-N33

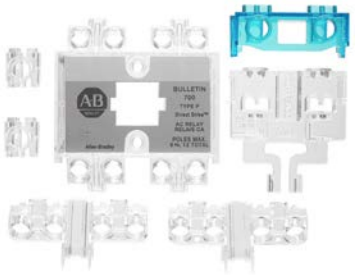
Surge Suppressors and Jumpers

	Description	Pkg. Qty.	Cat. No.	
	Surge Suppressors (RC Circuit) <ul style="list-style-type: none"> • Reduce the high transient voltages generated when the coil circuit is opened • Can be used with Bulletin 700-P, -PH, -PK, and -N relays and other electromechanical devices 	Mounting behind relay	1	700-N5
	<ul style="list-style-type: none"> • Contain a resistor and capacitor • Maximum ratings: 150V AC or DC, 35 VA. • Cat. No. 700-N5 requires 1 in. additional depth of enclosure. 	Mounting on coil terminal	1	700-N24

Surge Suppressors and Jumpers (Continued)

	Description	Pkg. Qty.	Cat. No.
	Surge Suppressor When the circuit to a DC operating coil is opened, the inductive energy stored in the coil can generate very high transient voltages. With the addition of the appropriate surge suppressor, the stored energy is absorbed and dissipated, limiting the voltage spikes. <ul style="list-style-type: none"> not required with AC 700-R or -RM relays because the AC operating coil transients are suppressed by a full wave rectifier connected to the coil 	24...48V AC/DC 1	199-FSMA9
		50...120V AC/DC 1	199-FSMA10
		130...250V AC/DC 1	199-FSMA11
	Diode Surge Suppressor <ul style="list-style-type: none"> for 6...300V DC voltage coils Used on Bulletin 700-P, -PH, -PK, -N, -F, and -R relays. 	1	199-FSMZ-1
	35 A Jumper Kit <ul style="list-style-type: none"> CSA Approved, UL Listed Can be used with any Bulletin 700-P and -PK AC or DC relay, Time-Delay relay or Latch Unit equipped with 20 A Master Cartridges Does not require any additional panel space. Jumper Kit terminals are designed for one #8 AWG wire or two #10 AWG wires. When connecting the two 20 A Master Cartridges in parallel, it is important that they be the same configuration (Normally Open or Normally Closed). Jumpers can be added to any contact cartridge location on a relay except the two center poles because of the wide spacing Adhesive label listing the contact ratings is included 	1	700-CPH
	Jumpers <ul style="list-style-type: none"> Not applicable for Bulletin 700-PH or -PK relays For connection between a middle pole and an outer pole on the left or right side of the relay 	for outer poles for middle poles 50	700-N3 700-N4
	Check Out Tool <ul style="list-style-type: none"> Mechanically maintains the Bulletin 700-P, -PH, or -PK relay in the energized position for troubleshooting purposes 	1	700-N23
	Adapter Plate <ul style="list-style-type: none"> Simplified relay conversion Lets you use the existing mounting holes when you replace a Bulletin 700-B, -BR, -BX, or -D relay with a Bulletin 700-P, -PH, or -PK relay. 	1	700-N34

IP2X Finger-safe Cover Accessories

	Description	Pkg. Qty.	Cat. No.	
	Top Covers <ul style="list-style-type: none"> Covering Top Level Contact Screws 	IP2X Top Cover for 700-P	1	700-PFSC
		Timer Top Cover Kit	1	700-PFSTC
		Latch Top Cover Kit (for Relays with Mechanical Latch Attachment)	1	700-PFSLCK
		Timer Top Cover Kit (for Master Cont. Relays with Pneumatic Timer)	1	700-PFSKTC
		Latch Top Cover Kit (for Master Cont. Relays with Mechanical Latch)	1	700-PFSKLCK
	Deck Covers <ul style="list-style-type: none"> Covering all terminals not on top deck Only for multi-deck relays 	IP2X Deck Cover for all AC and DC 700-P Relays	1	700-PFSDEK
	Coil Covers <ul style="list-style-type: none"> IP2X For all 700-P relays 	AC relays DC relays	1 1	700-PFSACC 700-PFSDCC

Specifications

Table 104 - Electrical Ratings

Type		Standard Cartridge						Master Cartridge						Heavy-duty							
Bulletin No.		700-P						700-PMCKIT						700-PHDKIT							
Contact Rating Continuous		10 A @ 600V AC ; 5 A @ 600V DC						20 A @ 600V AC; 10 A @ 600V DC						35 A @ 600V AC; 20 A @ 600V DC							
Ratings Make/Break	AC	NEMA A600						2 x NEMA A600						2 x NEMA A600							
	DC	NEMA P600						N150 P600						N150 P600							
Additional Contact Ratings for AC single-phase loads		-						3 Hp @ 240V AC - N.O. 2 Hp @ 240V AC - N.O./N.C. 1 Hp @ 120V AC - N.O./N.C. 20 A Resistive Heating to 600V AC 20 A Tungsten Lighting Load to 480V AC						5 Hp @ 240V AC - N.O. 3 Hp @ 240V AC - N.O./N.C. 2 Hp @ 120V AC - N.O./N.C. 35 A General Use At 0.75 PF to 600V AC 35 A Tungsten Lighting Load to 480V AC							
DC Current Ratings Make/Break		Cartridge Cat. No. 700-CP1						Cartridge Cat. No. 700-CPM						Cartridge Cat. No. 700-CPH							
DC Switching Inductive Load		Volts DC																			
		Contacts in Series	24	64	125	250	500	600	24	64	125	250	500	600	24	64	125	250	500	600	
			5 A	2.2 A	1.1 A	0.55 A	0.24 A	0.2 A	10 A	5 A	2.2 A	0.55 A	0.24 A	0.2 A	10 A	5 A	2.2 A	0.55 A	0.24 A	0.2 A	
		1	5 A	2.2 A	1.1 A	0.55 A	0.24 A	0.2 A	10 A	5 A	2.2 A	0.55 A	0.24 A	0.2 A	10 A	5 A	2.2 A	0.55 A	0.24 A	0.2 A	
		2	10 A	10 A	5 A	2 A	0.7 A	0.5 A	20 A	10 A	5 A	2 A	0.7 A	0.5 A	20 A	10 A	5 A	2 A	0.7 A	0.5 A	
3	-	-	7 A	3 A	1.5 A	1.0 A	-	15 A	7 A	3 A	1.5 A	1.0 A	-	15 A	7 A	3 A	1.5 A	1.0 A			
4	-	-	10 A	5 A	2.5 A	1.5 A	-	20 A	10 A	5 A	2.5 A	1.5 A	-	20 A	10 A	5 A	2.5 A	1.5 A			
Coil Voltage Range		AC	85...110%						85...110%						85...110%						
		DC	80...110%						80...110%						80...110%						
		Battery Charging	85...115%						85...115%						85...115%						
Coil Consumption				50 Hz			60 Hz			50 Hz			60 Hz			50 Hz			60 Hz		
		AC	Inrush	132VA ⁽¹⁾			138VA ⁽¹⁾			132VA ⁽¹⁾			138VA ⁽¹⁾			132VA ⁽¹⁾			138VA ⁽¹⁾		
			Sealed	19.3VA ⁽¹⁾			19VA ⁽¹⁾			19.3VA ⁽¹⁾			19VA ⁽¹⁾			19.3 VA ⁽¹⁾			19VA ⁽¹⁾		
		DC	Inrush	12.7VA ⁽¹⁾						12.7VA ⁽¹⁾						12.7VA ⁽¹⁾					
			Sealed	12.7VA ⁽¹⁾						12.7VA ⁽¹⁾						12.7VA ⁽¹⁾					
PLL - PKLL AC Latch Unit		Inrush	15VA ⁽¹⁾			15.6VA ⁽¹⁾			5VA ⁽¹⁾			15.6VA ⁽¹⁾			15VA ⁽¹⁾			15.6VA ⁽¹⁾			
		Sealed	5.4VA ⁽¹⁾			5.5VA ⁽¹⁾			5.4VA ⁽¹⁾			5.5VA ⁽¹⁾			5.4VA ⁽¹⁾			5.5VA ⁽¹⁾			
PLL - PKLL DC Latch Unit		Unlatch	35VA ⁽¹⁾						35VA ⁽¹⁾						-						
		Intermittent	35 W ⁽¹⁾						35 W ⁽¹⁾						-						
Reset Time	PT - PKT	75 ms						75 ms						-							
Minimum Pulse	PLL-PKLL	75 ms						75 ms						-							

(1) Average value for all coils within range. For values on a specific coil voltage, contact your local Rockwell Automation sales office or Allen-Bradley distributor.

Table 105 - Mechanical Ratings

Type		Standard Cartridge						Master Cartridge						Heavy-duty					
Bulletin No.		700-P						700-PMCKIT						700-PHDKIT					
Operating Time	Pickup	AC: 10...20 ms / DC - 30...50 ms						AC: 10...20 ms / DC - 30...50 ms						AC - 10...20 ms / DC - 30...50 ms					
	Dropout	AC - 10...20 ms / DC - 20...33 ms						AC - 10...20 ms / DC - 20...33 ms						AC - 10...20 ms / DC - 20...33 ms					
Mechanical Life		10 million operations																	

Table 106 - Construction Ratings

Type		Standard Cartridge						Master Cartridge						Heavy-duty					
Bulletin No.		700-P						700-PMCKIT						700-PHDKIT					
Contact Arrangement		Up to 12 Poles, Convertible to N.O. or N.C. (8 N.C. Maximum)												Up to 6 Poles, Convertible to N.O. or N.C. (4 N.C. Maximum)					
Contact Material		Silver Nickel						Silver Cadmium Oxide						Silver Cadmium Oxide					
Mounting		Panel, Strip Mount, or DIN Rail Horizontal Mounting Recommended																	

Table 107 - Environmental Ratings

Type		Standard Cartridge	Master Cartridge	Heavy-duty
Bulletin No.		700-P	700-PMCKIT	700-PHDKIT
Temperature	Operating ⁽¹⁾	-20...+65 °C (-4...+149 °F)	-20...+65 °C (-4...+149 °F)	-20...+65 °C (-4...+149 °F)
	Storage	-40...+65 °C (-40...+149 °F)	-40...+65 °C (-40...+149 °F)	-40...+65 °C (-40...+149 °F)

(1) Temperature inside the panel.

Table 108 - Wire Terminations

Type	Standard Cartridge	Master Cartridge	Heavy-duty
Bulletin No.	700-P	700-PMCKIT	700-PHDKIT
Wire size per UL/CSA		#18 AWG...(2) #12 AWG	
Tightening Torque		8...12 lb•in (0.9...1.4 N•m)	

Table 109 - Standards Compliance and Certifications

Type	Standard Cartridge	Master Cartridge	Heavy-duty
Bulletin No.	700-P	700-PMCKIT	700-PHDKIT
Standards Compliance	UL 508, CSA C22.2, No. 14, EN/IEC 60947-1, -5-1		
Certifications	cULus Listed (File No. E14840, Guide NKCR/NKCR7), CE Marked, ABS		

International Symbol for Mechanically Linked Contacts



Approximate Dimensions

Approximate dimensions are shown in millimeters (inches). Dimensions are not intended for manufacturing purposes.

Figure 105 - 2- and 4-pole 700-P Relay

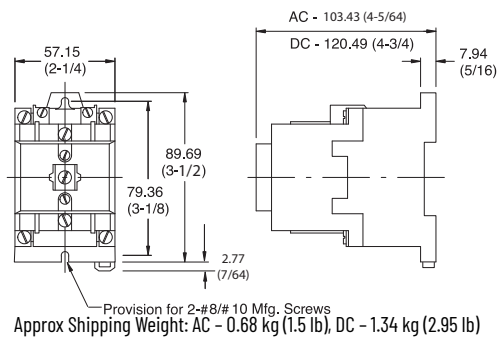


Figure 107 - 6- and 8-pole 700-P Relay with one -PB adder deck

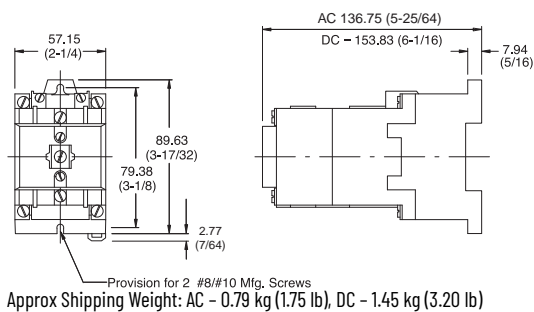


Figure 106 - 2- and 4-pole 700-P with Pneumatic Time Delay Attachment

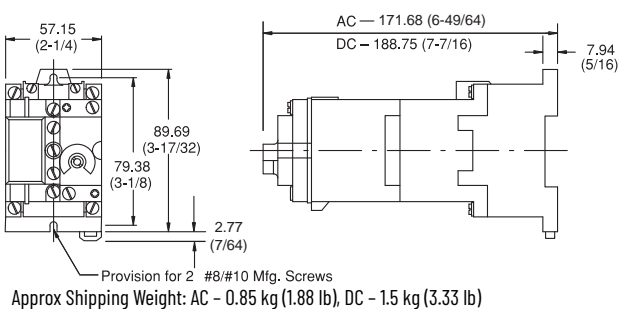


Figure 108 - 700-P Relay with Mechanical Latch Attachment

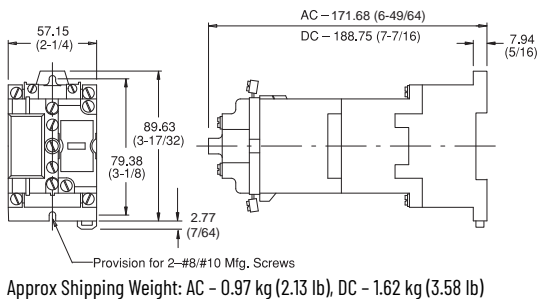
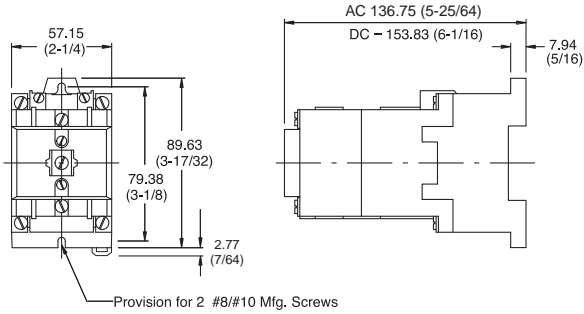
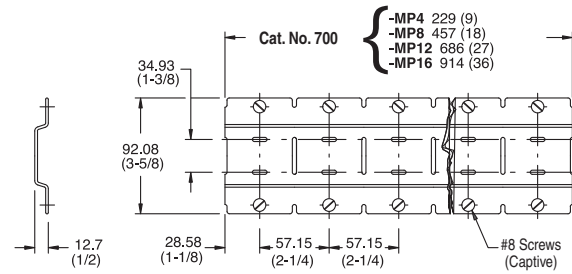


Figure 109 - 700-P Relay, up to 12 poles with -PB and -PC adder decks



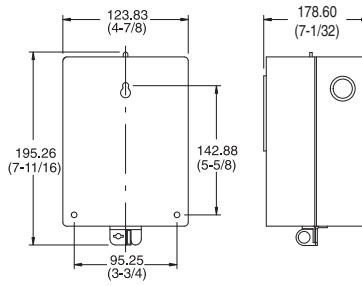
Approx Shipping Weight: AC - 1.02 kg (2.25 lb), DC - 1.68 kg (3.7 lb)

Figure 110 - Relay Rail for 700-P, -N, -NM, -R, -RM, -RT, -RTA Relays



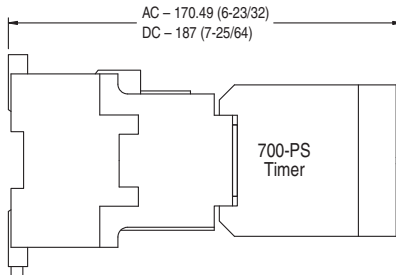
Secure the mounting strip with two screws at each end relay position. Use a minimum of one screw at the 3rd, 5th, 7th, etc., relay positions. Alternate between upper and lower horizontal slots.

Figure 111 - Cat. No. 700-N31, Type 1 Enclosure for 700-P, -RTC Relays



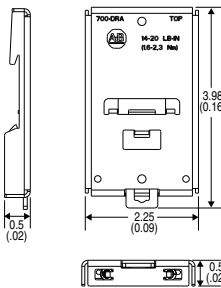
Approximate Shipping Weight: 1.26 kg (2.8 lb)

Figure 112 - 700-PS Timer Mounted on a 700-P Relay



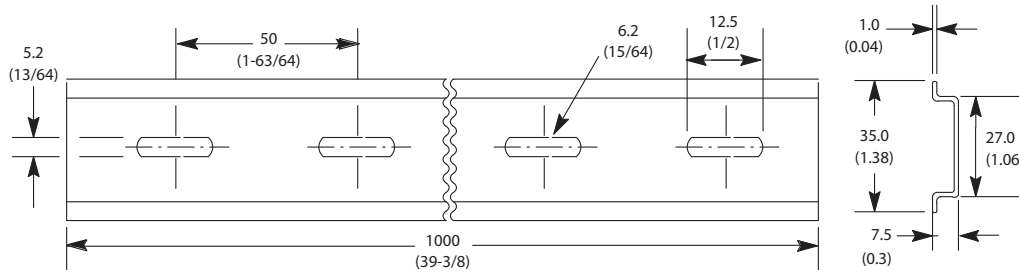
Approximate Shipping Weight: AC - 0.68 kg (1.5 lb) without 700-PS, DC - 1.34 kg (2.9 lb) without 700-PS

Figure 113 - Cat. No. 700-DRA DIN Rail Adapter



Approx Shipping Weight: AC - 0.97 kg (2.13 lb), DC - 1.62 kg (3.58 lb)

Figure 114 - Cat. No. 199-DR1 DIN Mounting Rail, Series B





700S-P and 700S-PK Heavy-duty Safety Control Relays



- Mechanically linked contacts meet IEC 947-5-1-L
- 2...12 poles – all mechanically linked
- Red cover for easy identification of safety circuits
- Tamper resistant cover helps prevent changes which could jeopardize safety
- IEC mechanically linked contacts symbol displayed on front
- Visual indication of contact state
- Ideal for use in safety circuits

700S-P (10 A) Safety Control Relays – AC and DC Coil Voltages

Contacts		Cat. No.		
 N.O.	 N.C.	AC Coils		24V DC Coils
		Open Type Panel Mount/Relay Rail Mount	Open Type Panel Mount/Relay Rail Mount	Open Type DIN Rail Mount
3	1	700S-P310⊗	700S-DCP310Z24	700S-DCP310DZ24
2	2	700S-P220⊗	700S-DCP220Z24	700S-DCP220DZ24
7	1	700S-P710⊗	700S-DCP710Z24	700S-DCP710DZ24
6	2	700S-P620⊗	700S-DCP620Z24	700S-DCP620DZ24
5	3	700S-P530⊗	700S-DCP530Z24	700S-DCP530DZ24
4	4	700S-P440⊗	700S-DCP440Z24	700S-DCP440DZ24
3	5	700S-P350⊗	700S-DCP350Z24	700S-DCP350DZ24
10	2	700S-P1020⊗	700S-DCP1020Z24	700S-DCP1020DZ24

⊗ AC Coil Voltage Code^(a)

The Cat. No. as listed is incomplete. Select a coil voltage code from the table below to complete the Cat. No. Example: Cat. No. 700S-P310 becomes Cat. No. 700S-P310A1 for a 120V AC coil.

Hz	24	115-120	230-240	460-480
60	A24	A1	A2	A4



IEC 947-5-1 Annex L has 2 requirements for a relay to meet for mechanically linked contacts:

- 1.) If a N.O. contact welds, all the N.C. contacts will remain open and meet a 2500V impulse test.
 - 2.) If a N.C. contact welds, all the N.O. contacts will remain open and meet a 2500V impulse test.
- 700S-P and 700S-DCP relays meet these requirements, including the 2500V impulse test.

The relays shown on this page are shipped from the factory with the 700-CPS safety cartridge installed and cannot be converted to N.O. or N.C. in the field.

(a) For other coil voltages, consult your local Rockwell Automation sales office or Allen-Bradley distributor.

700S-PK (20 A) Safety Control Relay

Contacts		Coil Voltage	Cat. No.
N.O.	N.C.		
7	1	110V AC	700S-PK710A1
6	2	110V AC	700S-PK620A1
5	3	110V AC	700S-PK530A1
4	4	110V AC	700S-PK440A1
3	5	110V AC	700S-PK350A1
10	2	110V AC	700S-PK1020A1
3	1	110V AC	700S-PK310A1
7	1	24V DC	700S-DCPK710Z24
6	2	24V DC	700S-DCPK620Z24
5	3	24V DC	700S-DCPK530Z24
4	4	24V DC	700S-DCPK440Z24
3	5	24V DC	700S-DCPK350Z24
10	2	24V DC	700S-DCPK1020Z24
3	1	24V DC	700S-DCPK310Z24

Specifications

700S-P Relays

Table 110 - Electrical Ratings

Type		700S-P					
Electrical							
Contact Rating Continuous		10 A @ 600V AC 5 A @ 600V DC					
Ratings Make/ Break	AC	NEMA A600					
	DC	NEMA P600					
Minimum Contact Switching Ratings		10V, 50 mA					
DC Switching Inductive Load	Contacts in Series	Volts DC					
		24V	64V	125V	250V	500V	600V
	1	5 A	2.2 A	1.1 A	0.55 A	0.24 A	0.2 A
	2	10 A	10 A	5 A	2 A	0.7 A	0.5 A
	3	—	—	7 A	3 A	1.5 A	1.0 A
4	—	—	10 A	5 A	2.5 A	1.5 A	
Contact Electrical Life— Resistive Loads		1.5 million operations at 10 A break at 120V AC 14 million operations at 1 A break at 120V AC 6 million operations at 1 A break at 24V DC					
Coil Voltage Range ⁽¹⁾	AC	85...110%					
	DC	80...110%					
	Battery Charging	85...115%					
Coil Consumption		50 Hz			60 Hz		
AC	Inrush	132 VA			138 VA		
	Sealed	19.3 VA			19 VA		
DC	Inrush	12.7 W					
	Sealed	12.7 W					

(1) Coil voltage required for proper operation (percent of rated coil voltage).

Table 111 - Mechanical Ratings

Type		700S-P	
Mechanically Linked Contacts		All contacts are mechanically linked per IEC 947- 5-1 annex L for 2 to 12 poles	
Operating Time	Pickup	AC - 10...20 ms DC - 30...50 ms	
	Dropout	AC - 10...20 ms DC - 20...33 ms	
Mechanical Life		10 million operations	

Table 112 - Construction Ratings

Type		700S-P	
Contact Arrangement		2...12 Poles, Double Break Contacts N.O. or N.C. (8 N.C. Maximum)	
Contact Material/Design		Silver Nickel/Bifurcated	
Mounting		Panel mount or mount on 700-MP Relay or DIN Rail Horizontal Mounting Recommended	

Table 113 - Environmental Ratings

Type		700S-P	
Operating Temperature ⁽¹⁾		-20...+65 °C (-4...+149 °F)	
Storage Temperature		-40...+65 °C (-40...+149 °F)	

(1) Temperature inside the panel.

Table 114 - Standards Compliance and Certifications

Type	700S-P
Standards Compliance	UL 508, CSA C22.2, No. 14, EN/IEC 60947-1, -5-1
Certifications	cULus Listed (File No. E14840, Guide NKCR/NKCR7), CE Marked, ABS

700S-PK Relays

Table 115 - Electrical Ratings

Type	700S-PK							
Contact Rating Continuous	20 A @ 600V AC 10 A @ 600V DC							
Ratings Make/ Break	AC	NEMA A600						
	DC	NEMA P600						
Additional Contact Ratings for AC Single-Phase Loss	3 Hp @ 240V AC - N.O. 2 Hp @ 240V AC - N.O./N.C. 1 Hp @ 120V AC - N.O./N.C. 20 A resistive heating to 600V AC 20 A Tungsten lighting load to 480V AC							
DC Current Ratings Make/Break	Cartridge Cat. No. 700-CMS							
DC Switching	Contacts in Series	Volts DC						
		24V	64V	125V	250V	500V	600V	
		1	10 A	5 A	2.2 A	0.55 A	0.24 A	0.2 A
		2	20 A	10 A	5 A	2 A	0.7 A	0.5 A
		3	—	15 A	7 A	3 A	1.5 A	1.0 A
4	—	20 A	10 A	5 A	2.5 A	1.5 A		
Coil Voltage Range ⁽¹⁾	AC	85...110%						
	DC	80...110%						
	Battery Charging	85...115%						
Coil Consumption	50 Hz			60 Hz				
AC	Inrush	132 VA			138 VA			
	Sealed	19.3 VA			19 VA			
DC	Inrush	12.7 W						
	Sealed	12.7 W						

(1) Coil voltage required for proper operation (percent of rated coil voltage).

Table 116 - Mechanical Ratings

Type	700S-PK	
Mechanically Linked Contacts	All contacts are mechanically linked per IEC 947-5-1 annex L for 2 to 12 poles	
Operating Time	Pickup	AC - 10...20 ms, DC - 30...50 ms
	Dropout	AC - 10...20 ms, DC - 20...33 ms

Table 117 - Construction Ratings

Type	700S-PK
Contact Arrangement	2...12 Poles, Double Break Contacts N.O. or N.C. (8 N.C. Maximum)
Contact Material/Design	Silver Cadmium Oxide
Mechanical (Mechanically Linked Contacts)	All contacts are mechanically linked per IEC 947-5-1 Annex L for 2 to 12 poles
Mounting	Panel mount or strip mount recommended

Table 118 - Environmental Ratings

Type	700S-PK
Operating Temperature ⁽¹⁾	-20...+65 °C (-4...+149 °F)
Storage Temperature	-40...+65 °C (-40...+149 °F)

(1) Temperature inside the panel.

Table 119 - Wire Terminations

Type	700S-PK
Wire size per UL/CSA	#18 AWG...(2) #12 AWG
Tightening Torque	8...12 lb•in (0.9...1.4 N•m)

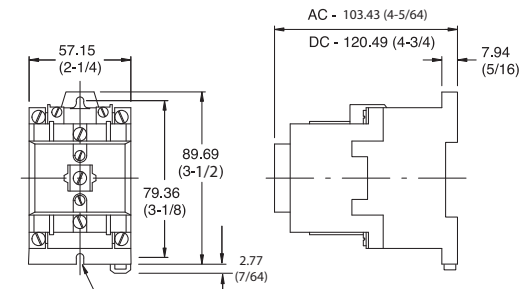
Table 120 - Standards Compliance and Certifications

Type	700S-PK
Standards Compliance	UL 508, CSA C22.2, No. 14, EN/IEC 60947-1, -5-1
Certifications	cULus Listed (File No. E14840, Guide NKCR/NKCR7), CE Marked, ABS

Approximate Dimensions

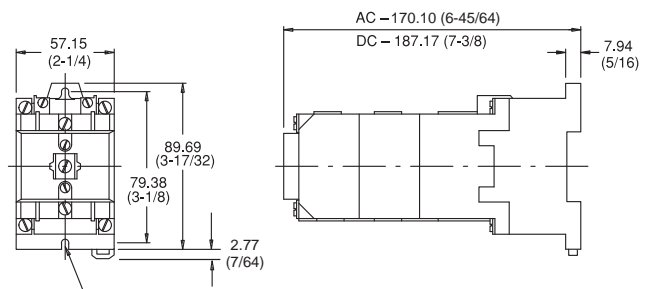
Approximate dimensions are shown in millimeters (inches). Dimensions are not intended for manufacturing purposes.

Figure 115 - 2- and 4-pole 700S-P Relay



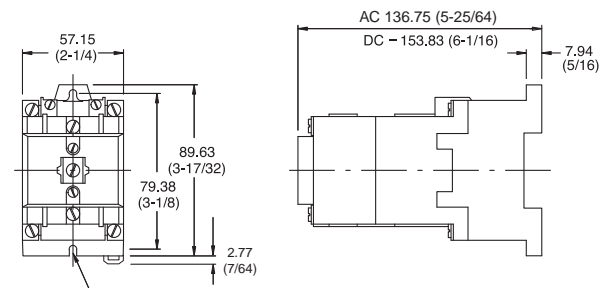
Approximate Shipping Weight: AC - 0.68 kg (1.5 lb), DC - 1.34 kg (2.95 lb)

Figure 117 - 10- and 12-pole 700S-P (Captive)



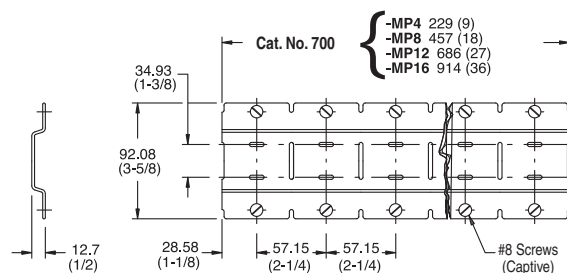
Approximate Shipping Weight: AC - 1.02 kg (2.25 lb), DC - 1.68 kg (3.7 lb)

Figure 116 - 6- and 8-pole 700S-P Relay



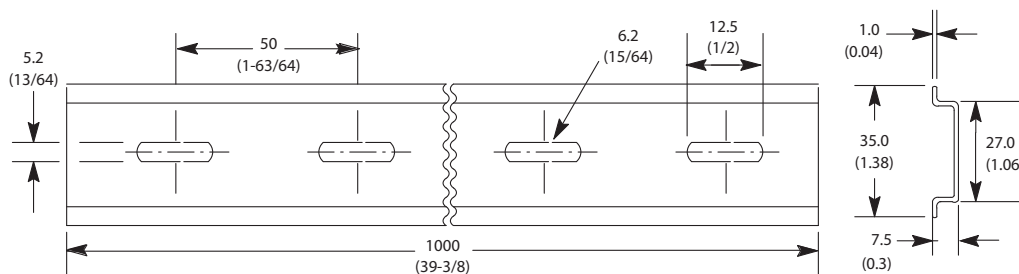
Approximate Shipping Weight: AC - 0.79 kg (1.75 lb), DC - 1.45 kg (3.20 lb)

Figure 118 - Relay Rail for 700-P, -N, -NM, -R, -RM, -RT, -RTA Relays



Secure the mounting strip with two screws at each end relay position. Use a minimum of one screw at the 3rd, 5th, 7th, etc., relay positions. Alternate between upper and lower horizontal slots.

Figure 119 - Cat. No. 199-DR1 DIN Mounting Rail, Series B



700-N Industrial Relays

- Contact cartridges convertible from N.O. to N.C. and vice versa
- NEMA A300 AC
- 24...250V AC coils
- Pneumatic timing unit
- Solid-state timing unit
- Overlap contacts
- Logic reed contacts
- 4-...8-pole



AC-Operated Relays

	Contacts		Contact Arrangement	Cat. No.
	N.O.	N.C.		
Type N Relay 4 Poles	4	—	4-Pole Relay 	700-N400⊗
Type NM Relay 2 Poles§	2	—	 ○ = Coil terminals 2 = Latch 3 = Unlatch	700-NM200⊗

⊗ AC Coil Voltage Code

The Cat. No. as listed is incomplete. Select a coil voltage code from the table below to complete the cat. no. Example: Cat. No. 700-N200⊗ becomes Cat. No. 700-N200A24 for 24V, 60 Hz. For other coil voltages, contact your local Rockwell Automation sales office or Allen-Bradley distributor.


Hz	24	110	120	208	220	240
50	—	A1	—	—	A2	—
60	A24	—	A1	A20	—	A2

IMPORTANT


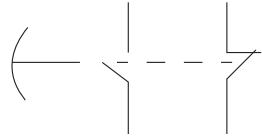
- **NORMALLY CLOSED CONTACTS:** Listed relays are supplied with all contacts normally open. These contacts can be readily converted to normally closed in the field.
- **OVERLAP CONTACTS:** Overlap contacts (normally open contact closes before the normally closed contact opens) can be supplied. See for information on kits for field installation of overlap contact cartridges.
- Location of contacts in 2-pole relays
- Permanent Magnet Latch AC Relay. Minimum Operating Time - Type NM - For reliable operation, power to the latch circuit must be maintained for a minimum time of 75 milliseconds and power to the unlatch circuit must be maintained for minimum time of 50 milliseconds.

Accessories


AC Operating Coils

	Coil Voltage [V AC]	700-N Relay, 2-...8-pole	
		60 Hz	50 Hz
	24	84AB27	84AB28
	110	84AB01	84AB86
	120	84AB86	—
	208	84AB113	—
	220	84AB06	84AB83
	240	84AB83	—







700-NT Pneumatic Timing Unit

	Description	Timed Contacts		Contact Arrangement	Cat. No.
		N.O.	N.C.		
	Timing Unit Only <ul style="list-style-type: none"> For 700-N, 2...4-pole devices ON-Delay mode is standard Timer is easily converted to OFF-Delay mode 	1	1		700-NT




Front Deck

	Description	Cat. No.
	Front Deck <ul style="list-style-type: none"> Does not include contact cartridges For Bulletin 700 4-pole relays Provides up to 4 additional convertible poles - without changing the mounting area 	700-NA00





Contact Cartridges (Convertible from N.O. to N.C. and N.C. to N.O.)

	Description	Cat. No.	
	Standard Contact Cartridges <ul style="list-style-type: none"> Available for adding to both rear deck and front deck 	Rear Deck Contact Cartridge	700-C1
		Front Deck Contact Cartridge	700-C2
	Gold-Plated Contact Cartridges <ul style="list-style-type: none"> May be used in low power circuits to improve reliability Good for long term storage, because gold resists corrosion 	Rear Deck Contact Cartridge	700-C1X
		Front Deck Contact Cartridge	700-C2X
	Logic Reed Cartridges <ul style="list-style-type: none"> Cartridges are hermetically sealed contact for low-energy switching 150V AC, 150 mA, 8VA Max 30V DC, 60 mA Max 	Rear Deck Contact Cartridge	700-C1R
	Bifurcated Contact Cartridges <ul style="list-style-type: none"> Cartridges are less apt to open because of vibration and shock 	Rear Deck Contact Cartridge	700-C1B
		Front Deck Contact Cartridge	700-C2B
	Overlap Contact Cartridges <ul style="list-style-type: none"> Cartridges are available in pairs The N.O. contact closes before the N.C. contact opens 300V AC max 125V DC max 	Rear Deck Contact Cartridge (1 pair per package)	700-C11Z
		Front Deck Contact Cartridge (1 pair per package)	700-C22Z
	Timing Unit Replacement (Bifurcated) Contact Cartridge for Bulletin 700-NT relay	Standard ontacts	X-457011
		Gold-plated contacts	41063-447-03

Mounting Accessories

	Description	Relays per Strip	Pkg. Qty.	Cat. No.
 <p>Relay Rail</p> <ul style="list-style-type: none"> • Simplifies panel layout • Indexed strips are easily cut to the required length and bolted, riveted, or spot-welded in place. • Relays are installed adjacent to one another on the mounting strip with the captive mounting screws provided • Rows of relays on Relay Rail form their own wiring trough • Can be used with the following relays: <ul style="list-style-type: none"> - 700P - 700DC-P - 700S-P - 700N - 700-R - 700-RTC 		4	5	700-MP4
		8	5	700-MP8
		12	5	700-MP12
		16	5	700-MP16
 <p>DIN (#3) symmetrical hat rail</p> <ul style="list-style-type: none"> • 35 x 7.5 x 1 m 			10	199-DR1
 <p>DIN Rail Adapter</p> <ul style="list-style-type: none"> • Can be used with the following relays: <ul style="list-style-type: none"> - 700P - 700DC-P - 700S-P - 700N - 700-R - 700-RTC 			1	700-DRA

Surge Suppressors and Jumpers

	Description		Pkg. Qty.	Cat. No.
 <p>Surge Suppressors (RC Circuit)</p> <ul style="list-style-type: none"> • Reduce the high transient voltages generated when the coil circuit is opened • Can be used with Bulletin 700-P, -PH, -PK, and -N relays and other electromechanical devices • Contain a resistor and capacitor • Maximum ratings: 150V AC or DC, 35 VA. • Cat. No. 700-N5 requires 1 in. additional depth of enclosure. 	Mounting behind relay		1	700-N5
	Mounting on coil terminal		1	700-N24
 <p>Jumpers</p> <ul style="list-style-type: none"> • Not applicable for Bulletin 700-PH or -PK relays • For connection between a middle pole and an outer pole on the left or right side of the relay 	for outer poles		50	700-N3
	for middle poles			700-N4
 <p>Check Out Tool</p> <ul style="list-style-type: none"> • Mechanically maintains the Bulletin 700-P, -PH, or -PK relay in the energized position for troubleshooting purposes 			1	700-N21

Specifications

Table 121 - Electrical Ratings

Attribute		Bul. 700-N		Bul. 700-NT
Rated Thermal Current I_{th}		10 A		
Rated Insulation Voltage		300V		
Contact Rating		10 A @ 300V AC, NEMA A300		
Coil Voltage Range	AC	85...110%		—
	DC	80...110%		—
Coil Consumption		50 Hz	60 Hz	—
AC	Inrush	120 VA	133 VA	—
	Sealed	24 VA	20 VA	—

Table 122 - Mechanical Ratings

Attribute		Bul. 700-N		Bul. 700-NT
Max. Operating Time	Pickup	14 ms		—
	Drop Out	13 ms		—
Timing Range		—		0.2...60 s
Repeat Accuracy		—		±15% of setting
Reset Time		—		75 ms
Timing Mode		—		On-Delay – convertible to OFF Delay, up to 2 poles convertible to N.O. or N.C.

Table 123 - Construction Ratings

Attribute	Bul. 700-N	Bul. 700-NT
Contact Arrangement	Up to 8 Poles, Convertible to N.O. or N.C.	—
Contact Material	Silver	Silver
Mounting	Panel or strip mount Horizontal mounting recommended	On relay only

Table 124 - Environmental Ratings

Attribute		Bul. 700-N	Bul. 700-NT
Ambient Temperature (Outside Enclosure)	Operating	-20...+40 °C (-4...+104 °F)	
	Storage	-40...+60 °C (-40...+140 °F)	
Operating Temperature Rise (Inside Enclosure)		+25 °C (77 °F)Max	—

Table 125 - Wire Terminations

Type	700S-PK
Wire size per UL/CSA	#18 AWG...(2) #12 AWG
Tightening Torque	8...12 lb•in (0.9...1.4 N•m)

Table 126 - Standards Compliance and Certifications

Type	700N, 700-NT
Standards Compliance	UL 508, CSA C22.2, No. 14
Certifications	cULus Listed (File No. E14840, Guide NKCR/NKCR7)

Approximate Dimensions

Approximate dimensions are shown in millimeters (inches). Dimensions are not intended for manufacturing purposes.

Type of Relay	No. of Poles	Open Type Without Enclosure					Approx. Ship. Wt. kg (lbs.)	Type 1 General Purpose Enclosure					Approx. Ship. Wt. kg (lbs.)
		Drawing Number	A Wide	B High	C Deep	D		A Wide	B High	C Deep	D	E	
700-N	2...4	1	57.15 (2-1/4)	88.90 (3-1/2)	82.55 (3-1/4)	79.38 (3-1/8)	0.68 (1-1/2)	107.95 (4-1/4)	185.74 (7-5/16)	103.19 (4-1/16)	146.05 (5-3/4)	85.73 (3-3/8)	1.59 (3-1/2)
	6...8	2	57.15 (2-1/4)	88.90 (3-1/2)	106.36 (4-3/16)	79.38 (3-1/8)	0.79 (1-3/4)	112.71 (4-7/16)	228.60 (9)	120.65 (4-3/4)	206.38 (8-1/8)	92.08 (3-5/8)	2.27 (5)
700-N with Pneumatic Timer	2...4	3	57.15 (2-1/4)	88.90 (3-1/2)	138.11 (5-7/16)	79.38 (3-1/8)	0.91 (2)	-	-	-	-	-	-
700-N with Solid-State Timer	2...4	3	57.15 (2-1/4)	88.90 (3-1/2)	160.34 (6-5/16)	79.38 (3-1/8)	1.02 (2-1/4)	-	-	-	-	-	-

Figure 120 - Drawing No. 1

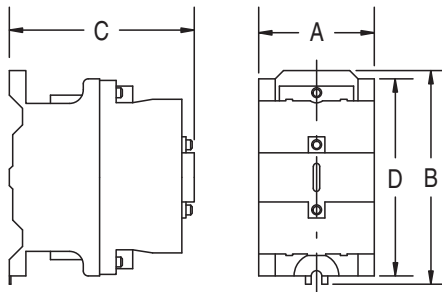


Figure 123 - Drawing No. 4

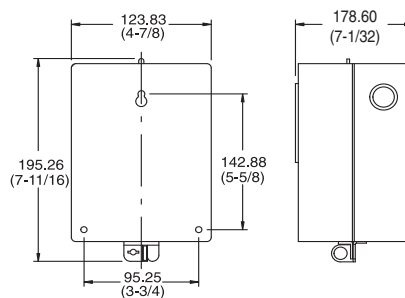


Figure 121 - Drawing No. 2

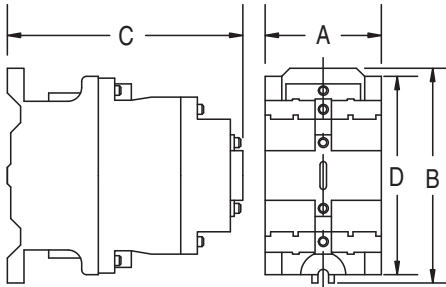


Figure 122 - Drawing No. 3

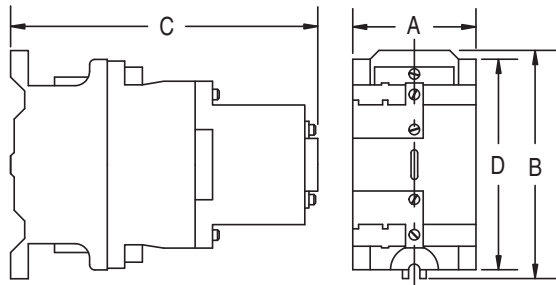
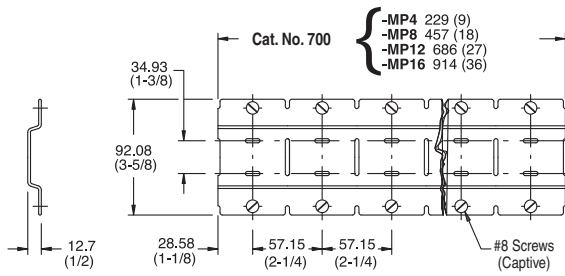
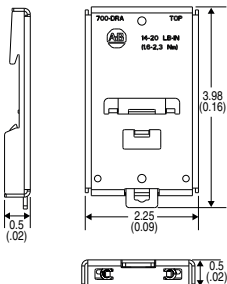


Figure 124 - Relay Rail for 700-P, -N, -NM, -R, -RM, -RT, -RTA Relays



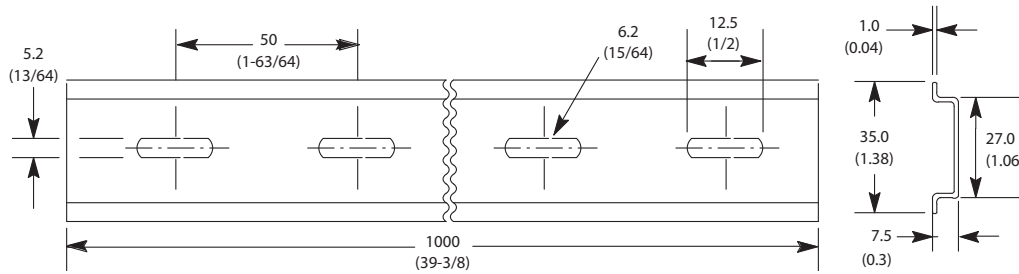
Secure the mounting strip with two screws at each end relay position. Use a minimum of one screw at the 3rd, 5th, 7th, etc., relay positions. Alternate between upper and lower horizontal slots.

Figure 125 - Cat. No. 700-DRA DIN Rail Adapter



Approx Shipping Weight: AC - 0.97 kg (2.13 lb), DC - 1.62 kg (3.58 lb)

Figure 126 - Cat. No. 199-DR1 DIN Mounting Rail, Series B



700-R Sealed Switch Relays

- Sealed contacts
- Extremely long mechanical and electrical life
- Hazardous locations Class 1, Div 2 Groups A, B, C, D
- Harsh environments
- Suitable for applications with shock and vibration
- High reliability circuit integrity



Open Type Relays with Electrically Held Contacts

No. of Poles	Contacts		Contact Arrangement and Markings†	Cat. No.		
	N.O.	N.C.		AC-Operated Relay	DC-Operated Relay	
0	0	0	Relay without Contact	700-R000⊗	700DC-R000⊗	
2	2	0		700-R200⊗	700DC-R200⊗	
	1	1		700-R110⊗	700DC-R110⊗	
	0	2		700-R020⊗	700DC-R020⊗	
4	4	0		700-R400⊗	700DC-R400⊗	
	3	1		700-R310⊗	700DC-R310⊗	
	2	2		700-R220⊗	700DC-R220⊗	
	1	3		700-R130⊗	700DC-R130⊗	
6	0	4		700-R040⊗	700DC-R040⊗	
	6	0			700-R600⊗	700DC-R600⊗
	5	1			700-R510⊗	700DC-R510⊗
	4	2	700-R420⊗		700DC-R420⊗	
	3	3	700-R330⊗		700DC-R330⊗	
	2	4	700-R240⊗		700DC-R240⊗	
	1	5	700-R150⊗		700DC-R150⊗	
0	6	700-R060⊗	700DC-R060⊗			
8	8	0			700-R800⊗	700DC-R800⊗
	7	1			700-R710⊗	700DC-R710⊗
	6	2			700-R620⊗	700DC-R620⊗
	5	3			700-R530⊗	700DC-R530⊗
	4	4			700-R440⊗	700DC-R440⊗
	3	5			700-R350⊗	700DC-R350⊗
	2	6			700-R260⊗	700DC-R260⊗
	1	7		700-R170⊗	700DC-R170⊗	
	0	8		700-R080⊗	700DC-R080⊗	

† Arrangement displays all N.O. contacts.
 ‡ Location of contacts in 6-pole relays.
 § Polarity must be observed for DC voltage (700 DC) relays.
 ¶ Location of contacts in 2-pole relays.


⊗ Coil Voltage Code

The Cat. No. as listed is incomplete. Select a coil voltage code from the table below to complete the cat. no. Example: Cat. No. 700-R000⊗ becomes Cat. No. 700-R000A24.




Current	Hz	24	48	110	120	208	220	230-250	240
AC	25	—	—	C11	C1	—	—	—	C2
	50	—	—	A1	—	—	A2	—	—
	60	A24	A48	—	A1	A20	—	—	A2
DC	—	Z24	Z48	—	—	Z1	—	Z2	—

Accessories


Operating Coils

	Coil Volts	700-R 2-...8-Pole AC		700-R 2-...8-Pole DC
		60 Hz	50 Hz	
	24	77AB27	77AB27	77D152
	48	77AB134	77AB134	77D166
	110	77AB86	77AB86	—
	115...125	—	—	77D155
	120	77AB86	77AB86	—
	208	—	—	—
	220	77AB83	77AB83	—
	240	77AB83	77AB83	—
	230...250	—	—	77D156



Mounting Accessories

	Description	Relays per Strip	Pkg. Qty.	Cat. No.
	Relay Rail <ul style="list-style-type: none"> • Simplifies panel layout • Indexed strips are easily cut to the required length and bolted, riveted, or spot-welded in place. • Relays are installed adjacent to one another on the mounting strip with the captive mounting screws provided • Rows of relays on Relay Rail form their own wiring trough • Can be used with the following relays: <ul style="list-style-type: none"> - 700P - 700DC-P - 700S-P - 700N - 700-R - 700-RTC 	4	5	700-MP4
		8	5	700-MP8
		12	5	700-MP12
		16	5	700-MP16
	DIN (#3) symmetrical hat rail <ul style="list-style-type: none"> • 35 x 7.5 x 1 m 		10	199-DR1
	DIN Rail Adapter <ul style="list-style-type: none"> • Can be used with the following relays: <ul style="list-style-type: none"> - 700P - 700DC-P - 700S-P - 700N - 700-R - 700-RTC 		1	700-DRA


Front Deck

	Description	Cat. No.	
	Front Deck <ul style="list-style-type: none"> • For Bulletin 700-R and 700DC-R 2-, 3-, and 4-pole relays 	1 N.O. contact (700-R relay)	700-RA10
		1 N.C. contact (700-R relay)	700-RA01
		1 N.O. contact (700-RM relay)	700-RB10
		1 N.C. contact (700-RM relay)	700-RB01

Contact Cartridges

	Description	Cartridge Type	Color	Cat. No.
	<p>Contact Cartridges</p> <ul style="list-style-type: none"> Used to increase no. of poles in a relay N.O., N.C., and Dummy cartridges are interchangeable Dummy cartridges should be placed in unused cartridge slots to guard against entrance of foreign material. 	N.O.	Green	700-CR5
		N.C.	Yellow	700-CR6
		Dummy	Black	700-CR9

Surge Suppressors

	Description	Pkg. Qty.	Cat. No.	
	<p>Surge Suppressor</p> <p>When the circuit to a DC operating coil is opened, the inductive energy stored in the coil can generate very high transient voltages. With the addition of the appropriate surge suppressor, the stored energy is absorbed and dissipated, limiting the voltage spikes.</p> <ul style="list-style-type: none"> not required with AC 700-R or -RM relays because the AC operating coil transients are suppressed by a full wave rectifier connected to the coil 	24...48V AC/DC	1	
		50...120V AC/DC	1	199-FSMA10
		130...250V AC/DC	1	199-FSMA11

Specifications

Application Data

Because of the inherent characteristics of this device, the normally open contacts may close before the normally closed contacts open on energization and the normally closed contacts may close before the normally open contacts open on de-energization.

Table 127 - Ratings

AC Voltage					DC Voltage				
NEMA Rating Designation	Voltage		Make	Break	Continuous Carrying Current [A]	NEMA Rating Designation	Volts DC	Make/Break	Continuous Carrying Current [A]
B300	Up to 300V AC	120V	30	3	5	NEMA P300	46...300	138 VA	5
		240V	15	1.5					
C600	Above 300V AC	480V	3.75	0.375	2.5		5...46	3 A	5
		600V	3.0	0.30					

Table 128 - Maximum Allowable Off-State Leakage Current

Voltage	Maximum Off-State Leakage Current [mA]
	Type R
24V DC	23
24V AC	23
120V AC	5

Table 129 - Relay Data

Type	700-R
Contact Arrangement	Up to 8 poles, available in any combination of N.O. or N.C. contacts
Contact Material	W (tungsten in a controlled gas atmosphere)
Coil Voltage Range	24...250V AC 24...250V DC
Coil Power	Sealed Voltage Range: -15... +10% 5.5 VA, 50/60 Hz 5.5 W DC
	Inrush 5.5 VA, 50/60 Hz 5.5 W DC
Pickup Time	30 ms
Dropout Time	30 ms
Operating Temperature	-40...+60 °C (-40...+140 °F)
Mounting	Panel mount
Haz. Loc. Ratings	Class I, Division 2, Groups A, B, C, and D
Standards Compliance	
Certifications	

Table 130 - Standards Compliance and Certifications

Type	700-R
Standards Compliance	ISA 12.12, CSA C22.2, No. 213, EN/IEC 60947-1, -5-1
Certifications	cULus Listed (File No. E10314, Guide NOIV/NOIV7), CE Marked

Approximate Dimensions

Approximate dimensions are shown in millimeters (inches).
Dimensions are not intended for manufacturing purposes.

700-R Relays													
Type of Relay	No. of Poles	Drawing Number	Open Type Without Enclosures				Approx. Ship Wt. [kg (lb)]	Type 1 General Purpose Enclosure					Approx. Ship Wt. [kg (lb)]
			A Wide	B High	C Deep	D		A Wide	B High	C Deep	D	E	
700-R, 700DC-R	2...4	1	55.56 (2-3/16)	88.90 (3-1/2)	92.25 (3-3/8)	79.38 (3-1/8)	0.91 (2)	104.78 (4-1/8)	185.74 (7-5/16)	103.19 (4-1/16)	146.05 (5-3/4)	85.73 (3-3/8)	1.81 (4)
	5...8	2	55.56 (2-3/16)	88.90 (3-1/2)	111.13 (4-3/8)	79.38 (3-1/8)	1.02 (2-1/4)	112.71 (4-7/16)	228.60 (9)	120.65 (4-3/4)	206.38 (8-1/8)	92.08 (3-5/8)	2.49 (5)

Figure 127 - 700-R400...

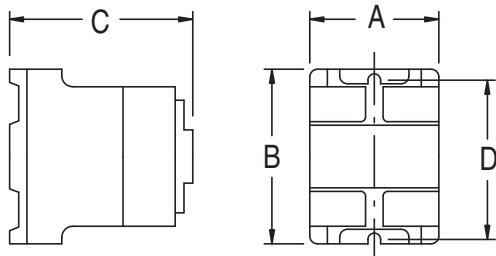


Figure 128 - 700-R800...

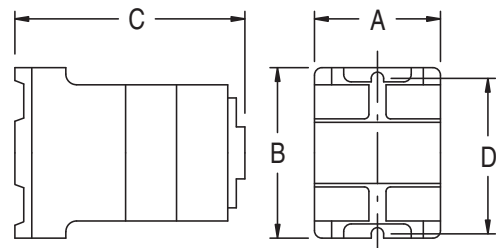


Figure 129 - Type 1 Enclosure

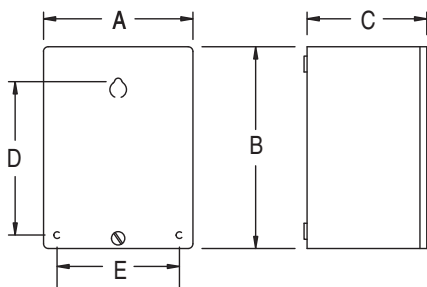


Figure 132 - Cat. No. 199-DR1 DIN Mounting Rail, Series B

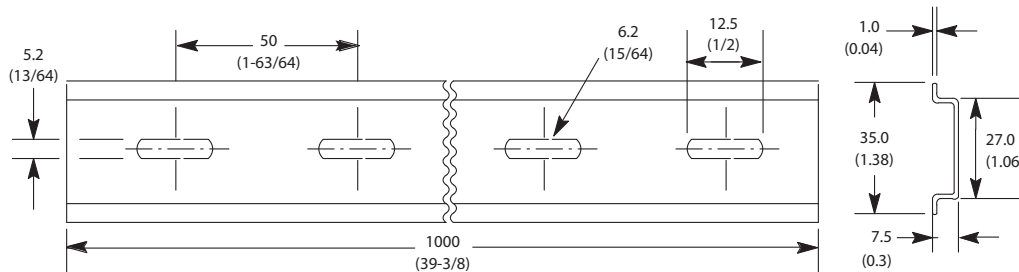
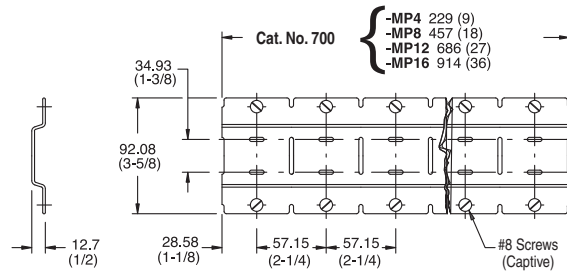
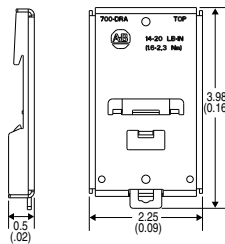


Figure 130 - Relay Rail for 700-P, -N, -NM, -R, -RM, -RT, -RTA Relays



Secure the mounting strip with two screws at each end relay position. Use a minimum of one screw at the 3rd, 5th, 7th, etc., relay positions. Alternate between upper and lower horizontal slots.

Figure 131 - Cat. No. 700-DRA DIN Rail Adapter



Approx Shipping Weight: AC - 0.97 kg (2.13 lb), DC - 1.62 kg (3.58 lb)

700-RTC – Solid-State Timing Relay

- Timing functions
- 8 ON-delay
- 8 OFF-delay
- Timing ranges
- Seconds: 0.05...2, 0.2...8, 0.4...30, 2...120
- Minutes: 0.015...1, 0.06...4, 0.25...16 and 1...64
- AC, 50/60 Hz or DC
- 600V AC maximum
- 300V DC maximum
- Relays with fixed time delay
- Sealed contacts
- Harsh environments
- Hazardous locations Class I, Div. 2, Groups A, B, C and D



Product Selection

Relays listed below have slots for two timed contacts and two instantaneous contacts. Unused slots are equipped with removable dummy cartridges.

700-RTC Relay with Adjustable Time Delay – Relays with Provision for Instantaneous Contacts

Total	Number of Contact Cartridges				Open Type Without Enclosure
	Instantaneous		Timed		
	N.O.	N.C.	N.O.	N.C.	
0	0	0	0	0	700-RTC00000⊗
1	0	0	1	0	700-RTC00100⊗
	0	0	0	1	700-RTC00010⊗
2	0	0	2	0	700-RTC00200⊗
	1	0	1	0	700-RTC10100⊗
	0	1	1	0	700-RTC01100⊗
	0	0	1	1	700-RTC00110⊗
	1	0	0	1	700-RTC10010⊗
	0	1	0	1	700-RTC01010⊗
	0	0	0	2	700-RTC00020⊗
	1	0	2	0	700-RTC10200⊗
3	2	0	1	0	700-RTC20100⊗
	0	1	2	0	700-RTC01200⊗
	1	1	1	0	700-RTC11000⊗
	1	0	1	1	700-RTC10110⊗
	2	0	0	1	700-RTC20010⊗
	0	2	1	0	700-RTC02100⊗
	0	1	1	1	700-RTC01110⊗
	1	1	0	1	700-RTC11010⊗
	1	0	0	2	700-RTC10020⊗
	0	2	0	1	700-RTC02010⊗
	0	1	0	2	700-RTC01020⊗

700-RTC Relay with Adjustable Time Delay - Relays with Provision for Instantaneous Contacts (Continued)

Total	Number of Contact Cartridges				Open Type Without Enclosure
	Instantaneous		Timed		Cat. No.
	N.O.	N.C.	N.O.	N.C.	
4	2	0	2	0	700-RTC20200⊗
	1	1	2	0	700-RTC11200⊗
	2	0	1	1	700-RTC20110⊗
	0	2	2	0	700-RTC02200⊗
	1	1	1	1	700-RTC11110⊗
	2	0	0	2	700-RTC20020⊗
	1	1	0	2	700-RTC11020⊗
	0	2	1	1	700-RTC02110⊗
	0	2	0	2	700-RTC02020⊗

⊗ Coil Voltage Code

The Cat. No. as listed is not complete. Select a voltage code from the table below to complete the Cat. No. Example: Cat. No. 700-RTC00100⊗ becomes Cat. No. 700-RTC00100U24. For other voltages consult your local Rockwell Automation sales office or Allen-Bradley distributor.

Hz	AC Voltage		DC Voltage	
	24	110/120	24	120
50/60	U24	U1	U24	U1

700-RTC Relays with Fixed Time Delay— Relays with Provision for Instantaneous Contacts

Total	Number of Contact Cartridges				Open Type Without Enclosure
	Timed		Instantaneous		Cat. No.
	N.O.	N.C.	N.O.	N.C.	
0	0	0	0	0	700-RTC00#0⊗
1	1	0	0	0	700-RTC10#0⊗
	0	1	0	0	700-RTC20#0⊗
2	2	0	0	0	700-RTC40#0⊗
	1	0	1	0	700-RTC11#0⊗
	1	0	0	1	700-RTC12#0⊗
	1	1	0	0	700-RTC30#0⊗
	0	1	1	0	700-RTC21#0⊗
	0	1	0	1	700-RTC22#0⊗
	0	2	0	0	700-RTC50#0⊗
3	2	0	1	0	700-RTC41#0⊗
	1	0	2	0	700-RTC14#0⊗
	2	0	0	1	700-RTC42#0⊗
	1	0	1	1	700-RTC13#0⊗
	1	1	1	0	700-RTC31#0⊗
	0	1	2	0	700-RTC24#0⊗
	1	0	0	2	700-RTC15#0⊗
	1	1	0	1	700-RTC32#0⊗
	0	1	1	1	700-RTC23#0⊗
	0	2	1	0	700-RTC51#0⊗
	0	1	0	2	700-RTC25#0⊗
	0	2	0	1	700-RTC52#0⊗

700-RTC Relays with Fixed Time Delay— Relays with Provision for Instantaneous Contacts (Continued)

Total	Number of Contact Cartridges				Open Type Without Enclosure
	Timed		Instantaneous		Cat. No.
	N.O.	N.C.	N.O.	N.C.	
4	2	0	2	0	700-RTC44#0⊗
	2	0	1	1	700-RTC43#0⊗
	1	1	2	0	700-RTC34#0⊗
	2	0	0	2	700-RTC45#0⊗
	1	1	1	1	700-RTC33#0⊗
	0	2	2	0	700-RTC54#0⊗
	1	1	0	2	700-RTC35#0⊗
	0	2	1	1	700-RTC53#0⊗
	0	2	0	2	700-RTC55#0⊗

Operating Mode

Replace the # in the cat. no. with the appropriate letter and numbers to indicate the operating mode and the fixed time delay value. Refer to operating mode table below.

Digit	Operating Mode	Fixed Time Delay
S	On-Delay - s	Seconds -Two digits indicating the fixed time delay in seconds.
Z	Off-Delay - s	Three digits indicating the fixed time delay (first digit indicates seconds, next two digits indicate 1/100 seconds).
Y	On-Delay - Min.	Minutes -Two digits indicating the fixed time delay in minutes.
I	Off-Delay - Min.	Three digits indicating the fixed time delay (first digit indicates minutes, next two digits indicate 1/100 minutes).

EXAMPLE Cat. No. **700-RTC00Y200U1** is for a relay without contact cartridges. "Y20" indicates an On-Delay timer with a 20 minute fixed time delay. This is a "standard relay." Order the contact cartridges separately.
 Cat. No. **700-RTC42S020U1** is for a relay with 2 N.O. cartridges in the timed position and 1 N.C. cartridge in the instantaneous position. "S02" indicates an On-Delay timer with a 2 second fixed time delay.




⊗ Coil Voltage Code

The Cat. No. as listed is not complete. Select a voltage code from the table below to complete the Cat. No. Example: Cat. No. 700-RTC00100⊗ becomes Cat. No. 700-RTC00100U24. For other voltages consult your local Rockwell Automation sales office or Allen-Bradley distributor.




Hz	AC Voltage		DC Voltage	
	24	110/120	24	120
50/60	U24	U1	U24	U1

Accessories

Cartridges and Enclosures

	Description	Cartridge Type	Color	Cat. No.
	Contact Cartridges <ul style="list-style-type: none"> Used to add contacts to timing relays with unused slots N.O., N.C., and Dummy cartridges are interchangeable <ul style="list-style-type: none"> can be used in timed or instantaneous contact slots Dummy cartridges should be placed in unused cartridge slots to guard against entrance of foreign material. 	N.O.	Grey	700-CRT5
		N.C.	Orange	700-CRT6
		Dummy	Black	700-CR9
				
	Type 1 Enclosure <ul style="list-style-type: none"> for all 700-P relays except: <ul style="list-style-type: none"> 10- and 12-pole DC relays 6-pole DC 700-PH relays. 			700-N31

Mounting Accessories

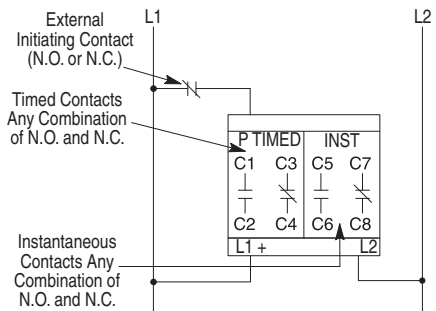
	Description	Relays per Strip	Pkg. Qty.	Cat. No.
	Relay Rail <ul style="list-style-type: none"> Simplifies panel layout Indexed strips are easily cut to the required length and bolted, riveted, or spot-welded in place. Relays are installed adjacent to one another on the mounting strip with the captive mounting screws provided Rows of relays on Relay Rail form their own wiring trough Can be used with the following relays: <ul style="list-style-type: none"> 700P 700DC-P 700S-P 700N 700-R 700-RTC 	4	5	700-MP4
		8	5	700-MP8
		12	5	700-MP12
		16	5	700-MP16
	DIN (#3) symmetrical hat rail <ul style="list-style-type: none"> 35 x 7.5 x 1 m 		10	199-DR1
	DIN Rail Adapter <ul style="list-style-type: none"> Can be used with the following relays: <ul style="list-style-type: none"> 700P 700DC-P 700S-P 700N 700-R 700-RTC 		1	700-DRA

Specifications

Table 131 - Voltage and Power Requirements

Voltage Type		Total Power Required	Initiate Terminal Power	Maximum Allowable Leakage Current	Coil Code
AC +10%/-15%, 50/60 Hz	24V AC	8 VA	4 VA	10 mA	U24
	110/120V AC	9 VA	4 VA	2.4 mA	U1
DC, +10%/-20%	24V DC	10 W	5 W	10 mA	U24
	120V DC	11 W	5 W	2.4 mA	U1

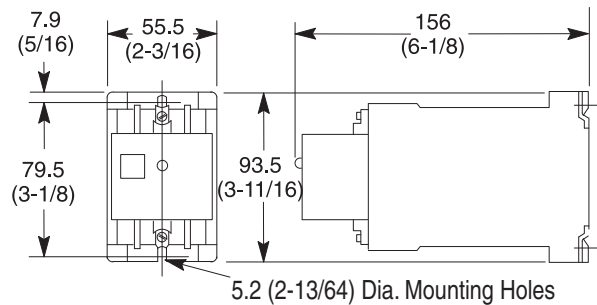
Figure 133 - Typical Wiring Diagram - 700-RTC Relays



Approximate Dimensions

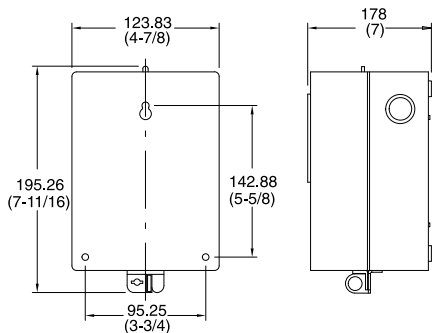
Approximate dimensions are shown in millimeters (inches). Dimensions are not intended for manufacturing purposes.

Figure 134 - 700-RTC Relays






Approximate Shipping Weight 0.92 kg (2.1 lb.)

Figure 135 - NEMA Type 1 Enclosure for RTC Relays



Approximate Shipping Weight 1.26 kg (2.8 lb.)

Product Overview

			
Bulletin No.	700-CF and 700S-CF	700-EF and 700S-EF	700-K
Type	Control Relay	Control Relay	Miniature Control Relay
Features	<ul style="list-style-type: none"> • Mechanically linked contacts • Timer and latch operations • Switch up to 690V AC and DC • 700S-CF for safety circuits 	<ul style="list-style-type: none"> • Mechanically linked contacts • Timer and latch operations • Switch up to 690V AC and DC • 700S-EF for safety circuits 	<ul style="list-style-type: none"> • Smallest size • Long life • Low power consumption • Switch up to 690V AC and DC
Contact Form	4...12 poles, double break	4...8 poles	4...8 Poles Double Break
Contact Type	Cross stamp or bifurcated	—	Bifurcated
Contact Material	Silver, gold	Silver	Silver
Max Current, AC resistive	20 A (relay) 10 A (adder deck)	16 A (relay) 16 A (adder deck)	10 A
Min Load	17V, 10 mA (Silver) 5V, 3 mA (Gold)	12V, 3 mA	15V, 2 mA
Coil Voltage	12...600V AC 9...250V DC	24...500V AC 12...500V DC	12...600V AC 9...250V DC
Coil Voltage Pickup	85...110% AC coils, 80...110% DC coils	85...110% AC coils, 80...110% DC coils	85...110% AC Coils, 80...110% DC Coils
Dielectric Withstand	2.5 kV	2.5 kV	2640V
Electric Service Life (cycles)	1.2 million at 10 A	1.2 million at 6 A	800k at 10 A 120V AC
Certifications	CE, cULus, CCC	CE, cULus, CCC	CE, cULus, CCC
Sockets	DIN Rail or panel mount	DIN Rail or panel mount	DIN Rail or panel mount
Page	189	189	219

700-CF Control Relay



- IEC industrial relays
- Mechanically linked contact performance per IEC 60947-5-1
- Gold plated, bifurcated version for low level switching applications
- Master control relay version rated 15 A (AC-15)
- Solid-state and pneumatic timing modules
- 4...10 Poles

Product Selection

4-Pole AC Coil Voltage⁽¹⁾

AC-12		AC-15							Connection Diagrams	Contacts		Cat. No.		
I_{th} [A]		I_e [A]										Standard Contacts ⁽²⁾	Gold-plated Bifurcated Contacts	Master Contacts
40 °C	60 °C	24/48V	120V	240V	400V	500V	600V	690V		N.O.	N.C.			
20	20	10	10	10	6	2.5	1	1		2	2	700-CF220⊗	700-CFB220⊗	700-CFM220⊗
										3	1	700-CF310⊗	700-CFB310⊗	700-CFM310⊗
										4	0	700-CF400⊗	700-CFB400⊗	700-CFM400⊗
										0	4	700-CF040⊗	700-CFB040⊗	—

(1) Ratings shown are for 700-CF relays only. See [Table 134](#) for ratings for 700-CFB and -CFM devices.

(2) For spring clamp terminals, insert R after 700-C. Example: Cat. No. 700-CRF220D.

⊗ Coil Voltage Code—see [page 191](#)

4-Pole DC Coil Voltage⁽¹⁾

AC-12		AC-15							Connection Diagrams	Contacts		Cat. No.		
I_{th} [A]		I_e [A]										Standard Contacts ⁽²⁾	Gold-plated Bifurcated Contacts	Master Contacts
40 °C	60 °C	24/48V	120V	240V	400V	500V	600V	690V		N.O.	N.C.			
20	20	10	10	10	6	2.5	1	1		2	2	700-CF220⊗	700-CFB220⊗	700-CFM220⊗
										3	1	700-CF310⊗	700-CFB310⊗	700-CFM310⊗
										4	0	700-CF400⊗	700-CFB400⊗	700-CFM400⊗

(1) Ratings shown are for 700-CF relays only. See [Table 134](#) for ratings for 700-CFB and -CFM devices.

(2) For spring clamp terminals, insert R after 700-C. Example: Cat. No. 700-CRF220D.

⊗ Coil Voltage Code—see [page 191](#)

6- and 8-Pole Control Relays with Overlapping Side-mounted Contacts

AC-12			AC-15							Left Aux.	Relay Arrangement	Right Aux.	Contacts		Overlapping Side-Mounted Contacts		Cat. No.
I_{th} [A]			I_e [A]										N.O.	N.C.	N.O.	N.C.	
40 °C	60 °C	24/48V	120V	240V	400V	500V	600V	690V									
Main Relay	20	20	10	10	10	6	2.5	1	1		4	0	1	1	700-CFZ1510⊗		
											3	1	1	1	700-CFZ1420⊗		
Side Contacts	10	10	6	6	5	3	1.6	1	1		2	2	1	1	700-CFZ1330⊗		
											4	0	2	2	700-CFZ2620⊗		
											3	1	2	2	700-CFZ2530⊗		
											2	2	2	2	700-CFZ2440⊗		

⊗ Coil Voltage Code—see [page 191](#)

Control Relays with Standard Side-mounted Contact

AC-12			AC-15							Left Aux.	Relay Arrangement	Right Aux.	Contacts		Standard Side-Mounted Contacts		Cat. No.
I_{th} [A]			I_e [A]										N.O.	N.C.	N.O.	N.C.	
40 °C	60 °C	24/48V	120V	240V	400V	500V	600V	690V									
Main Relay	20	20	10	10	10	6	2.5	1	1		4	0	1	1	700-CFZ0510⊗		
											3	1	1	1	700-CFZ0420⊗		
											2	2	1	1	700-CFZ0330⊗		
Side Contacts	10	10	6	6	5	3	1.6	1	1		4	0	2	2	700-CFZ0620⊗		
											3	1	2	2	700-CFZ0530⊗		
											2	2	2	2	700-CFZ0440⊗		

⊗ Coil Voltage Code—see [page 191](#)

⊗ AC Coil Voltage Code

The Cat. No. as listed is incomplete. Select a coil voltage code from the table below to complete the cat. no. Example: Cat. No. 700-CF220⊗ becomes Cat. No. 700-CF220D for 120V, 60 Hz.

Hz	12	24	32	35	42	48	100	100...110	110	120	127	200	200...220	208	208...240	220...230	230	230...240	240
50	R	K	V	W	X	Y	KP	—	D	P	S	KG	L	—	—	F	—	VA	T
60	Q	J	—	V	—	X	—	KP	—	D	—	—	KG	H	L	—	—	—	A
50/60	—	KJ	—	—	—	KY	KP	—	KD	—	—	KG	KL	—	—	KL	KF	—	KA

Hz	277	347	380	380...400	400	400...415	440	480	500	550	600
50	—	—	—	N	—	G	B	—	M	C	—
60	T	I	E	—	—	—	N	B	—	—	C
50/60	—	—	—	—	KN	—	KB	—	—	—	—

⊗ DC Coil Voltage Code

The Cat. No. as listed is incomplete. Select a coil voltage code from the table below to complete the cat. no. Example: Cat. No. 700-CF220⊗ becomes Cat. No. 700-CF220EJ for 24V DC, electronic with diode.

[V]	12	24	36	48...72	110...125	220...250
Electronic with diode	EQ	EJ	EW	EY	ED	EA
Electronic with diode/Quick Pick-up	—	QJ	—	—	—	—

Assignment of Contacts

Device Combinations in Accordance with IEC 60947-1 / -4-1

Auxiliary Contact Blocks		Control Relays 700-CF (AC and DC Control)		
Circuit Diagram	Control	700-CF⊗220	700-CF⊗310	700-CF⊗400


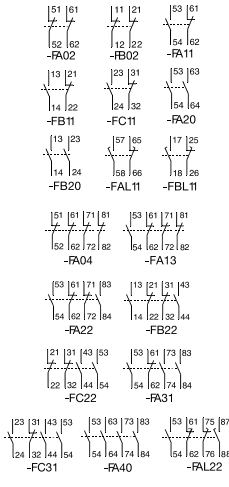

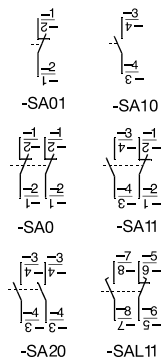
Front Mounting ⁽¹⁾

100-FA02		AC/DC	22E + 02E = 24Y	31E + 02E = 33Y	40E + 02E = 42Y
100-FA11		AC/DC	22E + 11E = 33Y	31E + 11E = 42Y	40E + 11E = 51Y
100-FA20		AC/DC	22E + 20E = 42Y	31E + 20E = 51Y	40E + 20E = 60Y
100-FA22		AC/DC	22E + 22E = 44Y	31E + 22E = 53Y	40E + 22E = 62Y
100-FA31		AC/DC	22E + 31E = 53Y	31E + 31E = 62Y	40E + 31E = 71Y
100-FA40		AC/DC	22E + 40E = 62Y	31E + 40E = 71Y	40E + 40E = 80Y
100-FAL22		AC/DC	22E + L22E = L44Y	31E + L22E = L53Y	40E + L22E = L62Y

(1) Control relay and auxiliary contact block AC/DC max. 4 N. C.

Accessories

Auxiliary Contact Blocks

	Description ⁽¹⁾	Connection Diagrams			For Use With	Cat. No.	
			N.O.	N.C.		Standard Auxiliary Contact ⁽²⁾	Bifurcated Auxiliary Contact
 <p>Auxiliary Contact Blocks for Front Mounting</p> <ul style="list-style-type: none"> • 2- and 4-pole • Quick and easy mounting without tools • Electronic-compatible contacts down to 17V, 5mA • Mechanically linked performance between N.O. and N.C. poles and to the main contactor poles (except for L types) • Models with equal function with several terminal numbering choices • 1L = Late break N.C. / early make N.O. • Bifurcated version for switching down to 5V, 3 mA also available 		0	2	700-CF	100-FA02	100-FAB02	
		1	1		100-FA11	100-FAB11	
		2	0		100-FA20	100-FAB20	
		1L	1L		100-FAL11	—	
		0	4		100-FA04	100-FAB04	
		1	3		100-FA13	100-FAB13	
		2	2		100-FA22	100-FAB22	
		3	1		100-FA31	100-FAB31	
		4	0		100-FA40	100-FAB40	
		1 + 1L	1 + 1L		100-FAL22	—	
		 <p>Auxiliary Contact Blocks for Side Mounting without Sequence Terminal Designations</p> <ul style="list-style-type: none"> • 1- and 2-pole • Two-way numbering for right or left mounting on the contactor • Quick and easy mounting without tools • Electronic-compatible contacts down to 17V, 10 mA • Mirror contact performance to the main contactor poles • 1L = Late break N.C. / early make N.O. 			0	1	700-CF
1	0			100-SA10	—		
0	2			100-SA02	—		
1	1			100-SA11	—		
2	0			100-SA20	—		
1L	1L			100-SAL11	—		

(1) Max. number of auxiliary contacts that may be mounted:
 AC and 24V DC electronic coil contactors—max. 4 N.O. contacts on the front of the contactor, 2 N.O. contacts on the side, 4 N.C. front or side, 6 total. DC Coil contactors—max. 4 N.O. contacts on the front of the contactor or max. 2 N.O. contacts on the side, 4 N.C. front or side, 4 total.
 (2) For screwless terminals (front mount only), insert "CR" after the "100-" in the catalog number. Example: Cat. No. 100-FA02 becomes Cat. No. 100-CRFA02.


 For maximum number of contacts, see [Table 132](#) and .

Table 132 - Max Contacts for 700-CF Relays with AC Electronic Coils, Vertical Mounting, 60 °C (140 °F)⁽¹⁾

Cat. No.	Max. N.O. Side Aux.	Max. N.C. Side Aux.	Max. N.O. Front Aux.	Max. N.C. Front Aux.	Max. N.O. Front + Side Aux.	Max. N.C. Front + Side Aux.	Max. N.O. + N.C. Front + Side Aux.
700-CF400	2	4	4	4	6	7	8
700-CF310	2	4 ⁽²⁾	4	4 ⁽³⁾	6	5	8
700-CF220	4	4 ⁽²⁾	4	2	8	5	8
700-CF040	2	2	4	0	6	2	6

(1) For other operating conditions, please contact your local Rockwell Automation sales office or Allen-Bradley distributor.
 (2) With no front auxiliary contacts installed. Otherwise 3 N.C. Maximum.
 (3) With no side auxiliary contacts installed. Otherwise 3 N.C. Maximum.





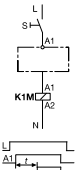
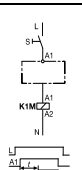

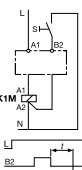
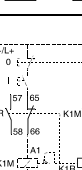

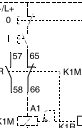
Table 133 - Max Contacts for 700-CF Relays with DC Conventional Coils, Vertical Mounting, 60 °C (140 °F)⁽¹⁾

Cat. No. 700-/700S-	Max. N.O. Side Aux.	Max. N.C. Side Aux.	Max. N.O. Front Aux.	Max. N.C. Front Aux.	Max. N.O. Front + Side Aux.	Max. N.C. Front + Side Aux.	Max. N.O. + N.C. Front + Side Aux.
CF400	2	2	4	4 ⁽²⁾	6	5	8
CF310	2	2	4	4 ⁽²⁾	6	5	8
CF220	2	2	4	2	8	4	8

(1) For other operating conditions, please contact your local Rockwell Automation sales office or Allen-Bradley distributor.
 (2) With no side auxiliary contacts installed. Otherwise 3 N.C. Maximum.

Control Modules

Timers

	Description		Connection Diagrams	For Use With	Cat. No.	
	Pneumatic Timing Modules • Pneumatic timing element contacts switch after the delay time. The contacts on the main control relay continue to operate without delay	On-Delay	0.3...30 s		700-CF with AC coils ⁽¹⁾	100-FPTA30
			2...180 s			100-FPTA180
		Off-Delay	0.3...30 s		700-CF all	100-FPTB30
			2...180 s			100-FPTB180
	Electronic Timing Modules – On-delay • Delay of the contactor or control relay solenoid. The contactor or control relay is energized at the end of the delay time.	On-Delay	0.1...3 s		700-CF with 110...240V, 50/60Hz coils	100-ETA3
			1...30 s			100-ETA30
			10...180 s			100-ETA180
		Off-Delay	0.1...3 s		700-CF with 24V DC coils	100-ETAZJ3
			1...30 s			100-ETAZJ30
			10...180 s			100-ETAZJ180
	Electronic Timing Modules – Off-delay • Delay of the contactor or control relay solenoid. After interruption of the control signal, the contactor or control relay is de-energized at the end of the delay time.	On-Delay	0.3...3 s		700-CF with 24V, 50/60Hz	100-ETBKJ3
			1...30 s			100-ETBKJ30
			10...180 s			100-ETBKJ180
		Off-Delay	0.3...3 s		700-CF with 110...240V 50/60Hz coils	100-ETB3
			1...30 s			100-ETB30
			10...180 s			100-ETB180
	Mechanical Latch • Following contactor latching, the contactor coil is immediately de-energized (off) by the N.C. auxiliary contact (65-66). • Electrical or manual release • 1 N.O. + 1 N.C. auxiliary contacts • Suitable for all Bul. 100-C contactor sizes, 9...97 A	Maximum command duration 0.03...10 s		700-CF with AC coils	100-FL11⊗	


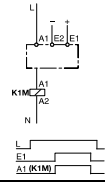

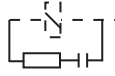
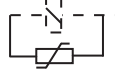
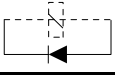
(1) Cannot be used with side-mounted auxiliary contacts on 700-CF DC relays.

⊗ **Coil Voltage Code:** The Cat. No. as listed is incomplete. Select a coil voltage code from the table below to complete the Cat. No. Example: 120V, 60 Hz: Cat. No. 100-FL11⊗ becomes Cat. No.100-FL11D

AC Voltages [V] ⁽¹⁾	24	48	100	110	120	230...240	240	277	380...400	400...415	440	480
50 Hz	K	Y	KP	D	—	VA	KA	—	N	G	B	—
60 Hz	J	—	—	—	D	—	KA	T	—	—	N	B

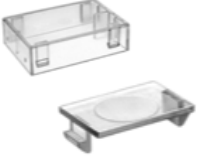
(1) For special voltages, consult your local Rockwell Automation sales office or Allen-Bradley distributor.

Additional Control Modules

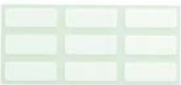


	Description		Voltage Range	Connection Diagrams	For Use With	Cat. No.	
	DC Interface (Electronic) <ul style="list-style-type: none"> Interface between the DC control signal (PLC) and the AC operating mechanism of the contactor. Requires no additional surge suppression on the relay coils. 		Input: 12V DC Output: 110...240V AC		700-CF with AC coils 110...240V AC	100-JE12	
			Input: 18...30V DC Output: 110...240V AC			100-JE	
			Input: 48V DC Output: 110...240V AC			100-JE48	
	Surge Suppressors <ul style="list-style-type: none"> For limitation of coil switching transients. Plug-in, coil mounted. Suitable for 100-C contactor sizes, 9...97 A. RC, varistor, and diode versions. 	RC Module AC operating mechanism	24...48V AC, 50/60 Hz		700-CF with AC coils	100-FSC48 ⁽¹⁾	
			110...280V AC, 50/60 Hz			100-FSC280 ⁽¹⁾	
			380...480V AC, 50/60 Hz			100-FSC480 ⁽¹⁾	
			Varistor Module AC/DC operating mechanism	12...55V AC, 12...77V DC		700-CF all	100-FSV55 ⁽¹⁾
				56...136V AC/78...180V DC			100-FSV136 ⁽¹⁾
				137...277V AC/ 181...350V DC			100-FSV277 ⁽¹⁾
				278...575V AC			100-FSV575 ⁽¹⁾
			Diode Module DC operating mechanism	1...30 s 10...180 s		700-CF with DC coils	100-FSD250 ⁽¹⁾

(1) For screwless terminals, insert "CR" after the "100-" in the catalog number. Example: Cat No. 100-FSC48 becomes Cat. No.-CRFSC48.

Assembly Components

	Description	For Use With	Pkg. Qty.	Cat. No.
	Protective Covers <ul style="list-style-type: none"> Provides protection against unintended manual operation For contactors and front-mounted auxiliary contacts, pneumatic timers, and latches 	700-CF all	1	100-SCCA
		100-FA, -FB, -FC, -FP, -FL	10	100-SCFA

Marking Systems (For 100-C09...C97 contactors)

	Description	Pkg. Qty. ⁽¹⁾	Cat. No.
	Label Sheet <ul style="list-style-type: none"> 105 self-adhesive paper labels each, 6 x 17 mm 	10	100-FMS
	Marking Tag Sheet <ul style="list-style-type: none"> 106 perforated paper labels each, 6 x 17 mm, to be used with a transparent cover 	10	100-FMP
	Transparent Cover <ul style="list-style-type: none"> To be used with marking tag sheets 	100	100-FMC
	Marking Tag Adapters <ul style="list-style-type: none"> To be used with 1492W marking tag system 	100	100-FMA2

(1) Must be ordered in multiples of package quantities

Renewal Parts

Replacement Coils for AC Contactors



AC Standard Control Voltages [V]			AC Coil Code	Cat. No.
50 Hz	60 Hz	50/60 Hz		
—	12	—	Q	TA006
12	—	—	R	TA404
—	24	—	J	TA013
24	—	—	K	TA407
—	—	24	KJ	TA855
32	36	—	V	TA481
36	42	—	W	TA410
42	48	—	X	TA482
48	—	—	Y	TA414
—	—	48	KY	TA860
100	100...110	100	KP	TA861
110	120	—	D	TA473
—	—	110	KD	TA856
120	—	—	P	TA425
127	—	—	S	TA428
200	200...220	200	KG	TA862
—	208	—	H	TA049
200...220	208...240	—	L	TA296
—	—	200...230	KL	TA864
220	240	—	A	TA474
220...230	260	—	F	TA441
—	—	230	KF	TA851
230...240	—	—	VA	TA440
240	277	—	T	TA480
—	—	240	KA	TA858
—	347	—	I	TA065
—	380	—	E	TA067
380...400	440	—	N	TA071
—	—	400	KN	TA863
400...415	—	—	G	TA457
440	480	—	B	TA475
—	—	440	KB	TA859
500	—	—	M	TA479
550	600	—	C	TA476

Replacement Coils for DC Contactors



DC Control Voltage [V]	DC Coil Code	Cat. No.
12V Electronic ⁽¹⁾	EQ	TC708E
24V Electronic ⁽¹⁾	EJ	TC714E
24V Electronic ⁽²⁾	QJ	TC714Q
36...48V Electronic ⁽¹⁾	EW	TC719E
48...72V Electronic	EY	TC724E
110...125V Electronic ⁽³⁾	ED	TC733E
220...250V Electronic	EA	TC747E

(1) Voltage operating range: 0.7...1.25 U_s

(2) Faster drop-out time (16...21 ms)


(3) Voltage operating range: 0.7...1.25 U_s at 110V DC

Specifications

Table 134 - Main Circuits

		Main Relay Cat. Nos. 700-CF, 700S- CF	Front Mounted Standard Auxiliary Contacts	Main Relay Cat. No. 700-CFB, 700S- CFB	Master Relay Cat. No. 700-CFM	Front Mounted Bifurcated Auxiliary Contacts	Side-mounted Auxiliary Contacts
Contact Ratings – NEMA		A600, P600	A600, Q600	A600, Q600	2 x A600, P600	A600, Q600	A600, Q600
Min. Contact Rating		17V, 10 mA	17V, 5 mA	8V, 5 mA	–	5V, 3 mA	17V, 10 mA
Contact Ratings – IEC AC-15 (solenoids, contactors) at rated voltage IEC 60947-5-1	24V	10 A	6 A	3 A	15 A	3 A	6 A
	48V	10 A	6 A	3 A	15 A	3 A	6 A
	120V	10 A	6 A	3 A	15 A	3 A	6 A
	240V	10 A	5 A	3 A	15 A	3 A	5 A
	400V	6 A	3 A	2 A	7.5 A	2 A	3 A
	480V/500V	2.5 A	1.6 A	1.2 A	5 A	1.2 A	1.6 A
	600V	1 A	1 A	0.7 A	2 A	0.7 A	1 A
	690V	1 A	1 A	0.7 A	2 A	0.7 A	1 A
AC-12 (Control of resistive loads) IEC 60947-5-1	40 °C	I_{th}	20 A	10 A	10 A	20 A	10 A
		230V	8 kW				
		400V	14 kW				
		690V	24 kW				
	60 °C	I_{th}	20 A	6 A	6 A	20 A	6 A
		230V	8 kW				
		400V	14 kW				
		690V	24 kW				
DC-12 Switching DC Loads L/R < 1ms, Resistive Loads IEC 60947-5-1	24V	15 A	10 A	6 A	20 A	6 A	6 A
	48V	10 A	9 A	3.2 A	20 A	3.2 A	3.2 A
	110V	6 A	3.5 A	1 A	8 A	1 A	1 A
	220V	1 A	0.7 A	0.5 A	1.5 A	0.5 A	0.5 A
	440V	0.4 A	0.2 A	0.2 A	0.4 A	0.2 A	0.2 A
DC-13 IEC 60947-5-1, Solenoids and contactors	24V	5 A	5 A	2.5 A	5 A	2.5 A	5 A
	48V	3 A	3 A	1.5 A	3 A	1.5 A	2.5 A
	110V	1.2 A	1.2 A	0.6 A	1.2 A	0.6 A	0.68 A
	220V	0.6 A	0.6 A	0.3 A	0.6 A	0.3 A	0.32 A
	440V	0.3 A	0.15 A	0.15 A	0.3 A	0.15 A	0.15 A




Table 135 - Mechanically Linked Contacts

	Location of welded N.O. contacts	State of N.C. Contacts if N.O. contact welds		
		Main	Front aux.	Side aux.
Mechanically Linked Contacts ⁽²⁾	Main	Open	Open	Open ⁽¹⁾
	Front aux.	Open	Open	–

(1) Defined in IEC 60947-5-1 annex L. Mechanically linked is a relationship between contacts of opposite types (i.e., N.O. and N.C.).

(2) Side mounted auxiliary contacts provide "mirror contact" performance with main poles only.

Table 136 - Terminals

Attribute			Cat. No. 700-CF	Aux./Pneumatic Timer Contact (Front mounted)
Mechanical Life		[Mil]	15	5
Electrical Life	AC-15 (240V, 3 A)	[Mil]	1.5	1.5
Weight	AC Coil	[g]	390	—
Terminal Cross-Sections				
Terminal Type				
Terminal Size per IEC60 947-1			2 x A4	2 x A4
	Solid/Stranded	1 Conductor	[mm ²]	1.5...6
	(1)	2 Conductor	[mm ²]	1.5...6
Max. Wire Size per UL/CSA			[AWG]	18...14
Tightening Torque			[lb•in]	13.3...17.7
			[N•m]	1.5...2.0

(1) For 16 or more strands, end ferrule is required.

Table 137 - DC Switching Ratings for 700-CF Main Poles in Series (Resistive Load at 60 °C)

Attribute	1 pole	2 poles	3 poles
24/48V	15/10 A	25 A	25 A
125V	6 A	25 A	25 A
220V	1 A	6 A	25 A
440V	0.4 A	1 A	3 A

Table 138 - Control Circuit

Attribute		Cat. No. 700-CF			
Operating Voltage	AC 50/60 Hz	Pickup	[x U _s]	0.85...1.1	
		Dropout	[x U _s]	0.3...0.6	
	DC (conventional) ⁽¹⁾	Pickup	[x U _s]	0.8...1.1	
		Dropout	[x U _s]	0.1...0.6	
	DC (electronic E0, EW)	Pickup	[x U _s]	0.7...1.25	
		Dropout	[x U _s]	0.3...0.4	
	DC (electronic EY)	Pickup	[x U _s]	0.8...1.25	
		Dropout	[x U _s]	0.3...0.4	
	DC (electronic ED)	Pickup	[x U _s]	0.7...1.12 ⁽²⁾	
		Dropout	[x U _s]	0.3...0.4	
	DC (electronic EA)	Pickup	[x U _s]	0.8...1.1	
		Dropout	[x U _s]	0.3...0.4	
	Coil Consumption	AC 50/60 Hz	Inrush	[VA]	75
			Sealed	[VA/W]	9.5/2.7
DC (conventional)		Inrush	[W]	7.7	
		Sealed	[W]	6.3	
DC (electronic E0, EJ)		Inrush (avg./ peak)	[W]	10/17	
		Sealed	[W]	1.7	
DC (electronic EY)		Inrush (avg./ peak)	[W]	10/17	
		Sealed	[W]	1.9	
DC (electronic ED)		Inrush (avg./ peak)	[W]	12/19	
		Sealed	[W]	2.1	
DC (electronic EA)		Inrush (avg./ peak)	[W]	14/22	
		Sealed	[W]	3.0	

Table 138 - Control Circuit (Continued)

Attribute			Cat. No. 700-CF	
Operating Times	AC 50/60 Hz	Pickup Time	[ms]	15...30
		Dropout Time	[ms]	10...60
	DC (conventional)	Pickup Time	[ms]	40...70
		Dropout Time	[ms]	7...15
	With integrated diode	Opening Delay	[ms]	14...20
	With external diode	Opening Delay	[ms]	70...125
	DC (electronic- EQ, EJ)	Closing Delay	[ms]	25...50
		Opening Delay	[ms]	27...45
	DC (electronic - EWEY, ED, EA)	Closing Delay	[ms]	25...50
		Opening Delay	[ms]	23...33
	DC (electronic- QJ)	Closing Delay	[ms]	20...50
		Opening Delay	[ms]	15...22
	Min OFF time			[ms]
Max. ripple				± 15%
Latch Attachment Release, 100-FL	Coil Consumption	AC	[VA/W]	45/40
		DC	[W]	25
	Contact Signal Duration		[min./max]	0.03...15 s
Timing Attachment	Reset Time, 100- ETA, 100-ETB	at min. time setting	[ms]	10
		at max. time setting	[ms]	70
	Repeat Accuracy			

(1) For 9V DC, code ZR, use operating voltage $0.65...1.3 \times U_s$. For 24V DC, code ZJ, DJ, or EJ use operating voltage $0.7...1.25 \times U_s$.

(2) At 110V DC, coil code ED has an operating voltage range of $0.7...1.25 \times U_s$.

Table 139 - General Specifications

Attribute		Cat. No. 700-CF	
Rated Insulation Voltage U_i	IEC	690V	
	UL; CSA	600V	
Rated Impulse Strength U_{imp}		6 kV	
High Test Voltage 1 minute (per IEC 60947-4)		2500V	
Rated Voltage U_e	AC	115, 230, 400, 500, 690V	
	DC	24, 48, 110, 220, 440V	
Short-Circuit Protection gG Fuse		20 A	
Rated Frequency		50/60 Hz, DC	
Ambient Temperature	Storage	-55...+80 °C (-67...+176 °F)	
	Operation at nominal current	-25...+60 °C (-13...+140 °F)	
15% current reduction for AC-12 at > 60 °C		-25...+70 °C (-13...+158 °F)	
Corrosion Resistance		humid-alternating climate, cyclic, per IEC 60068-2-30 and DIN 50 016, 56 cycles	
Altitude		2000 m above mean sea level, per IEC 60 947-4	
Type of Protection	IP2X (IEC 60529 and DIN 40050)	in connected state	
Shock Resistance		IEC 60068-2: Half sinusoidal shock 11 ms, 30 G (in 3 directions)	
Vibration Resistance		IEC 60068-2: Static >2 G, in normal position no malfunction <5 G	
Standards Compliance		UL 508, CSA C22.2 No. 14, EN/IEC 60947-1, -5-1, Meets the material restrictions for European Directive 2002/95/EC - EU-RoHS	
Certifications		cULus Listed (File No. E14840, Guide NKCR/NKCR7), CE Marked, CCC Certified	

Table 140 - Utilization Category Table from EN 60947-5-1: Verification of Making and Breaking Capacities of Switching Elements Under Normal Conditions Corresponding to the Utilization Categories ⁽¹⁾

Utilization Category	Normal Condition of Use								
	Make ⁽²⁾			Break ⁽²⁾			Number and Rate of Making and Breaking operations		
	I/I_e	U/U_e	$\cos \varphi$	I/I_e	U/U_e	$\cos \varphi$	No. operating cycles ⁽³⁾	Operating cycles per minute	ON time [s] ⁽⁴⁾
AC-12 ⁽⁵⁾	1	1	0.9	1	1	0.9	6050	6	0.05
AC-13 ⁽⁵⁾	2	1	0.65	1	1	0.65	6050	6	0.05
AC-14 ⁽⁵⁾	6	1	0.3	1	1	0.3	6050	6	0.05
AC-15 ⁽⁵⁾	10	1	0.3	1	1	0.3	6050	6	0.05
DC	—	—	$T_{0.95}$	—	—	$T_{0.95}$	—	—	—
DC-12	1	1	1 ms	1	1	1 ms	6050	6	0.05
DC-13	1	1	$6 \times P$ ⁽⁶⁾	1	1	$6 \times P$ ⁽⁶⁾	6050	6	0.05
DC-14 ⁽⁵⁾	10	1	15 ms	1	1	15 ms	6050	—	0.05

(1) See sub-clause 8.3.3.5.2.

(2) For tolerances on test quantities, see sub-clause 8.3.2.2.

(3) The first 50 operating cycles shall be run at $U/U_e = 1.1$ with the loads set at U_e .(4) The ON time shall be at least equal to $T_{0.95}$. I_e : Rated operational current, I Current to be made or broken U_e : Rated operational voltage, U Voltage before make $T_{0.95}$: Time to reach 95% of the steady-state current (ms)

(5) Where the break current differs from the make current value, the ON time refers to the make current value after which the current is reduced to the break current value for a suitable period example: 0.05 s.

(6) The value " $6 \times P$ " results from an empirical relationship which is found to represent most DC magnetic loads to an upper limit of $P = 50$ W, e.g., $6 \times P = 300$ W.**Table 141 - Contact Rating Table from EN 60947-5-1: Examples of Contact Rating Designation Based on Utilization Categories**

NEMA Designation ⁽¹⁾	IEC Utilization Category	Conventional Thermal Current I_{the} [A]	Rated Operational Current I_e (A) at Rated Operational Voltage U_e						VA Rating	
			120V	240V	380V	480V	500V	600V	Make	Break
AC			120V	240V	380V	480V	500V	600V	Make	Break
A150	AC-15	10	6	—	—	—	—	—	7200	720
A300	AC-15	10	6	3	—	—	—	—	7200	720
A600	AC-15	10	6	3	1.9	1.5	1.4	1.2	7200	720
B150	AC-15	5	3	—	—	—	—	—	3600	360
B300	AC-15	5	3	1.5	—	—	—	—	3600	360
B600	AC-15	5	3	1.5	0.95	0.75	0.72	0.6	3600	360
C150	AC-15	2.5	1.5	—	—	—	—	—	1800	180
C300	AC-15	2.5	1.5	0.75	—	—	—	—	1800	180
C600	AC-15	2.5	1.5	0.75	0.47	0.375	0.35	0.3	1800	180
D150	AC-15	1.0	0.6	—	—	—	—	—	432	72
D300	AC-14	1.0	0.6	0.3	—	—	—	—	432	72
E150	AC-14	0.5	0.3	—	—	—	—	—	216	36
DC			125V	250V	440V	500V	600V	—	Make	Break
N150	DC-13	10	2.2	—	—	—	—	—	275	275
N300	DC-13	10	2.2	1.1	—	—	—	—	275	275
N600	DC-13	10	2.2	1.1	0.63	0.55	0.4	—	275	275
P150	DC-13	5	1.1	—	—	—	—	—	138	138
P300	DC-13	5	1.1	0.55	—	—	—	—	138	138
P600	DC-13	5	1.1	0.55	0.31	0.27	0.2	—	138	138
Q150	DC-13	2.5	0.55	—	—	—	—	—	69	69
Q300	DC-13	2.5	0.55	0.27	—	—	—	—	69	69
Q600	DC-13	2.5	0.55	0.27	0.15	0.13	0.1	—	69	69
R150	DC-13	1.0	0.22	—	—	—	—	—	28	28
R300	DC-13	1.0	0.22	0.1	—	—	—	—	28	28

(1) This letter stands for the conventional thermal current and identifies AC or DC: for example, B=5 A AC. The number that follows is the rated insulation voltage.

Table 142 - Specifications 100-J... DC Interfaces

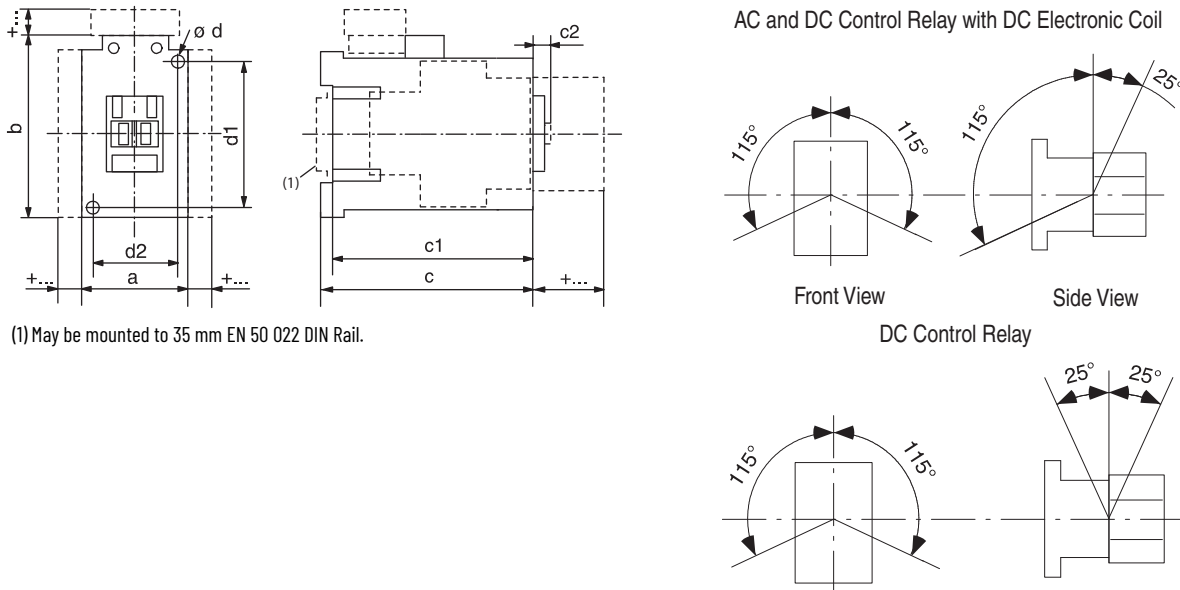
			Cat. No. 100-JE	Cat. No. 100-JE12	Cat. No. 100-JE48	
Electrical	Input Voltage		24V DC	12V DC	48V DC	
	Input Voltage Range		18...30V DC	6...12V DC	35...48V DC	
	Output Voltage		110...240V AC	110...240V AC	110...240V AC	
	Power Consumption		0.1...0.4 W	0.02...0.12 W	0.2...0.5 W	
	Minimum Actuation		5V DC, 2 mA DC	5V DC, 2 mA DC	5V DC, 2 mA DC	
Mechanical	Finger Protection		IP20	IP20	IP20	
	Pickup Time		0...10 ms + pickup time of the contactor	0...10 ms + pickup time of the contactor	0...10 ms + pickup time of the contactor	
	Dropout Time		0...10 ms + dropout time of the contactor	0...10 ms + dropout time of the contactor	0...10 ms + dropout time of the contactor	
	Max. Cycles Per Second		2 ⁽¹⁾	2 ⁽¹⁾	2 ⁽¹⁾	
	Isolation/Breakdown Voltage		In: 50V, Out: 250V	In: 50V, Out: 250V	In: 50V, Out: 250V	
	Rated Impulse Withstand Voltage		4 kV	4 kV	4 kV	
Environmental	Ambient Temperature Range		-25...+60 °C	-25...+60 °C	-25...+60 °C	
	Storage Temperature Range		-50...+80 °C	-50...+80 °C	-50...+80 °C	
	Operating Life		100 + million ops	100 + million ops	100 + million ops	
Construction	Wire Size Range	Flexible wire	1 Wire	0.5...2.5 mm ²	0.5...2.5 mm ²	0.5...2.5 mm ²
			2 Wire	0.75...2.5 mm ²	0.75...2.5 mm ²	0.75...2.5 mm ²
		Solid wire	1 Wire	1.0...2.5 mm ²	1.0...2.5 mm ²	1.0...2.5 mm ²
			2 Wire	1.0...2.5 mm ²	1.0...2.5 mm ²	1.0...2.5 mm ²
	Solid and Stranded		18...14 AWG	18...14 AWG	18...14 AWG	
	Tightening Torque		1...1.5 N•m / 7...15 lb•in	1...1.5 N•m / 7...15 lb•in	1...1.5 N•m / 7...15 lb•in	
Type of Light		LED	LED	LED		

(1) To consider the maximum operations/hour of the relays.

Approximate Dimensions

Approximate dimensions are shown in millimeters (inches). Dimensions are not intended for manufacturing purposes.

Figure 136 - Mounting Position



All AC Control Relays and DC Control Relays with 12V or 24V DC Electronic Coil

Type	a	b	c	c1	c2	Ød	d1	d2
700-CF, -CFB, -CFM	45 (1-25/32)	81 (3-3/16)	80.5 (3-11/64)	75.5 (3-3/32)	6 (1/4)	2 screws 4.5 (3/16)	60 (2-23/64)	35 (1-25/64)

DC Control Relays with 48...72V, 110...125V or 220...250V DC Electronic Coil

Type	a	b	c	c1	c2	Ød	d1	d2
700-CF, -CFB, -CFM	45 (1-25/32)	105 (4-1/8)	80.5 (3-11/64)	75.5 (3-3/32)	6 (1/4)	2 screws 4.5 (3/16)	60 (2-23/64)	35 (1-25/64)

DC Control Relays with Conventional Coil

Type	a	b	c	c1	c2	Ød	d1	d2
700-CF, -CFB, -CFM	45 (1-25/32)	81 (3-3/16)	106.5 (4-3/16)	101.5 (4)	6 (1/4)	2 screws 4.5 (3/16)	60 (2-23/64)	35 (1-25/64)

Table 143 - Accessories - 700-CF Relays

Relay with		AC Control Relay		DC Control Relay	
		mm	(inches)	mm	(inches)
Auxiliary Contact for Front Mounting	2- or 4-pole	c/c1 + 39	(c/c1 + 1 - 37/64)	c/c1 + 39	c/c1 + 1 - 37/64)
Auxiliary Contact for Side Mounting	1- or 2-pole	a + 9	(a + 23/64)	a + 9	(a + 23/64)
Pneumatic Timing Module	—	c/c1 + 58	(c/c1 + 2 - 23/64)	—	—
Solid-state Timing Module	on coil terminal side	b + 24	(b + 15/16)	b + 24	(b + 15/16)
Mechanical Latching	—	c/c1 + 63	(c/c1 + 2 - 31/64)	—	—
DC Interface	on coil terminal side	b + 9	(b + 23/64)	—	—
Surge Suppressor	on coil terminal side	b + 3	(b + 1/8)	b + 3	(b + 1/8)
Labeling with:	label sheet	+0	(+0)	+0	(+0)
	marking tag with cover	+0	(+0)	+0	(+0)
	marking tag carrier for System V4/V5	+5.5	(+7/32)	+5.5	(+7/32)
	marking tag carrier for System Bull. 1492W	+5.5	(+7/32)	+5.5	(+7/32)

700S-CF Control Relays

The 700S-CF Safety Control Relay provides mechanically or mirror contact performance, which are required in feedback circuits for safety applications. Bifurcated contacts are ideal for low energy feedback safety circuits where high contact reliability is required.

- IEC industrial safety relay
- Mechanically linked contacts as per IEC 60947-5-1
- Third party certification SUVA
- Red cover and mechanically linked contact symbol on front face
- Gold plated, bifurcated version for low level switching applications
- Permanently fixed front mounted auxiliary contact block



Product Selection

Type CF and CFB Safety Control Relays – 8-Pole AC Coil Voltage⁽¹⁾

AC-12			AC-15							Connection Diagrams		Contacts		Standard Contacts (Main) Gold-Plated Bifurcated (Front) Cat. No.	Gold-Plated Bifurcated, All Contacts Cat. No.
I_{th} [A]			I_e [A]							Main Contacts	Auxiliary Contacts				
	40 °C	60 °C	24/48V	120V	240V	400V	500V	600V	690V			N.O.	N.C.		
Main Contacts	20	20	10	10	10	6	2.5	1	1			4	4	700S-CF440⊗BC	700S-CFB440⊗C
												5	3	700S-CF530⊗BC	700S-CFB530⊗C
Adder Deck Contacts	10	6	6	6	5	3	1.6	1	1			6	2	700S-CF620⊗BC	700S-CFB620⊗C

(1) Ratings shown are for 700S-CF relays only. See Table 134 for ratings for 700S-CFB devices.

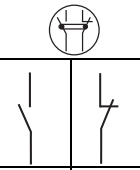
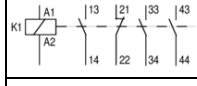

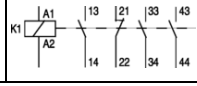
⊗ AC Coil Voltage Code

The Cat. No. as listed is incomplete. Select a coil voltage code from the table below to complete the cat. no. Example: Cat. No. 700S-CF440⊗ becomes Cat. No. 700S-CF440D for 120V, 60 Hz.

Hz	12	24	32	35	42	48	100	100...110	110	120	127	200	200...220	208	208...240	220...230	230	230...240	240
50	R	K	V	W	X	Y	KP	—	D	P	S	KG	L	—	—	F	—	VA	T
60	Q	J	—	V	—	X	—	KP	—	D	—	—	KG	H	L	—	—	—	A
50/60	—	KJ	—	—	—	KY	KP	—	KD	—	—	KG	KL	—	—	KL	KF	—	KA

Hz	277	347	380	380...400	400	400...415	440	480	500	550	600
50	—	—	—	N	—	G	B	—	M	C	—
60	T	I	E	—	—	—	N	B	—	—	C
50/60	—	—	—	—	KN	—	KB	—	—	—	—

Type CF and CFB Safety Control Relays – 8-Pole DC Coil Voltage⁽¹⁾

AC-12			AC-15							Connection Diagrams		Contacts		Standard Contacts (Main) Gold-Plated Bifurcated (Front) Cat. No.	Gold-Plated Bifurcated, All Contacts Cat. No.
I_{th} [A]			I_e [A]							Main Contacts	Auxiliary Contacts				
	40 °C	60 °C	24/48V	120V	240V	400V	500V	600V	690V			N.O.	N.C.		
Main Contacts	20	20	10	10	10	6	2.5	1	1		4	4	700S-CF440⊗BC	700S-CFB440⊗C	
												5	3	700S-CF530⊗BC	700S-CFB530⊗C
Adder Deck Contacts	10	6	6	6	5	3	1.6	1	1		6	2	700S-CF620⊗BC	700S-CFB620⊗C	

(1) Ratings shown are for 700S-CF relays only. See Table 134 for ratings for 700S-CFB devices.

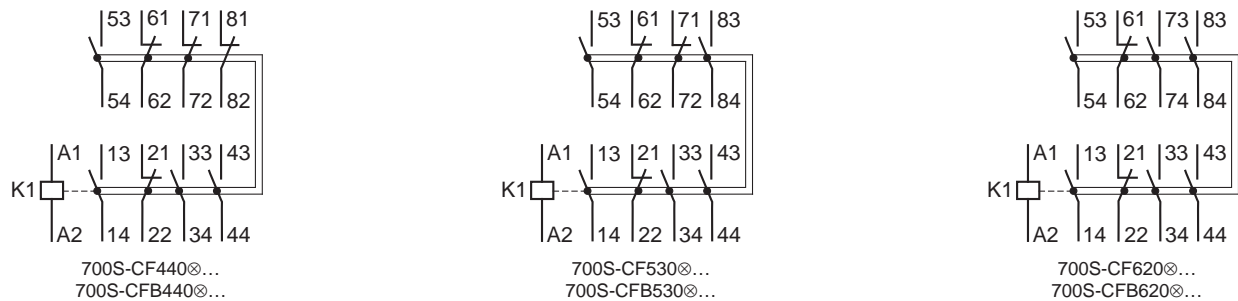
⊗ DC Coil Voltage Code

The Cat. No. as listed is incomplete. Select a coil voltage code from the table below to complete the cat. no. Example: Cat. No. 700-CF220⊗ becomes Cat. No. 700-CF220EJ for 24V DC, electronic with diode.

[V]	12	24	36	48...72	110...125	220...250
Electronic with diode	EQ	EJ	EW	EY	ED	EA




Assignment of Contacts

Figure 137 - Safety Control Relays with Front-mount Auxiliary Contacts, 8-Pole AC or DC Coil Voltage



Specifications

For more 700S-CF Specifications, see [Table 134 on page 196](#).

			Cat. No. 700S-CF	Aux. Contact (Front-mounted)	
Mechanical Life		[Mil]	15	15	
Electrical Life	AC-15 (240V, 3 A)	[Mil]	1.5	1.5	
Weight	AC Coil	[g]	390	—	
Terminal Cross-Sections					
Terminal Type					
Terminal Size per IEC 947-1			2 x A4	2 x A4	
	Solid/ Stranded ⁽¹⁾	1 Conductor	[mm ²]	1.5...6	0.5...2.5
		2 Conductor	[mm ²]	1.5...6	0.75...2.5
Max. Wire Size per UL/CSA		[AWG]	16...10	18...14	
Tightening Torque		[lb•in]	13.3...22	8.9...13.3	
Tightening Torque		[N•m]	1.5...2.5	1...1.5	
Standards Compliance			UL 508, CSA C22.2 No. 14, EN/IEC 60947-1, -5-1, Meets the material restrictions for European Directive 2002/95/EC - EU-RoHS		
Certifications			cULus Listed (File No. E14840, Guide NKCR/NKCR7), CE Marked, CCC Certified		

(1) For 16 or more strands, end ferrule is required

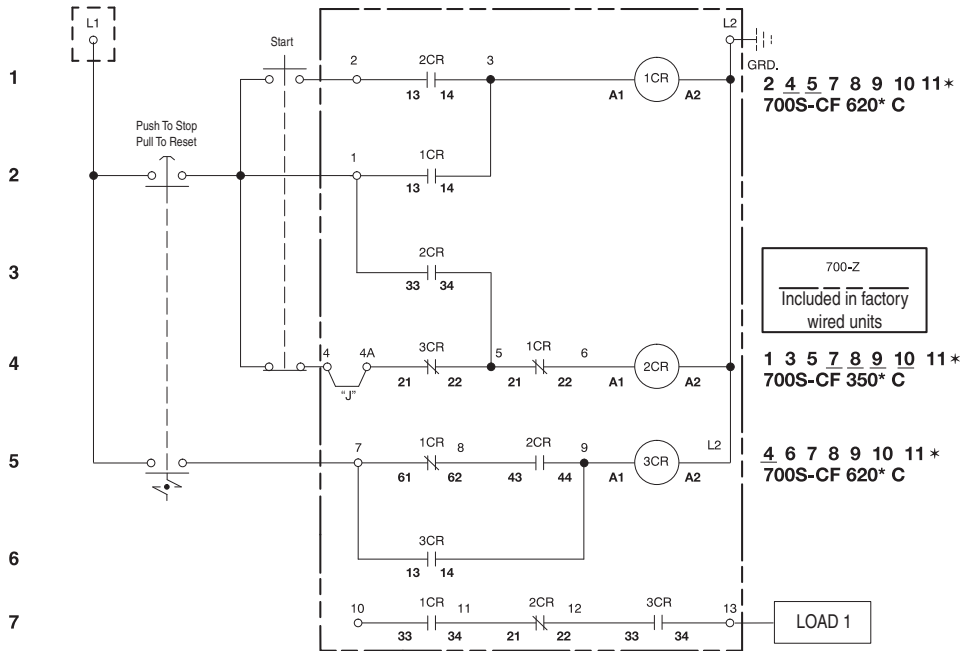
Safety Relay Circuit With 5 Safety Outputs

- Use for E-stop control. E-stop will work properly if any one fault occurs (a fault could be one welded contact or one undesired open connection such as a loose wire).
- High output switching capability and long contact life.
- Circuit complies with EN 954 categories 1, 2, 3, 4.
- Helps prevent restart of the 5 safety outputs if there is a single fault anywhere in the system.
- Use three 700S-CF relays and [Figure 138](#) to construct the circuit.

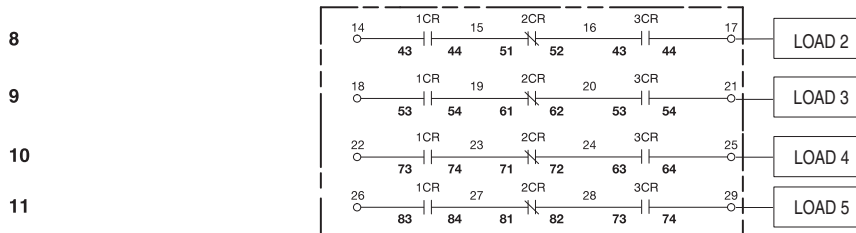
Figure 138 - 700S-CF Circuit

Basic Circuit

(1) Output Circuit (3 Relays, 9 Terminal Blocks)



(5) Output Circuit (3 Relays, 17 Terminal Blocks)



* Numbers shown are the line numbers where the contacts for this relay appear. Contact your local Rockwell Automation sales office or Allen-Bradley distributor for availability.

Approximate Dimensions

Approximate dimensions are shown in millimeters (inches). Dimensions are not intended for manufacturing purposes.

Figure 139 - Mounting Position

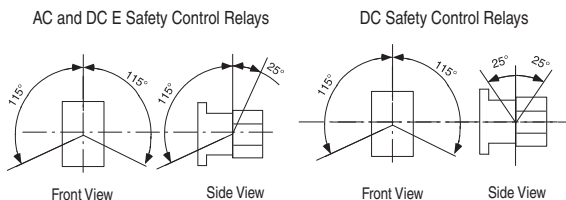
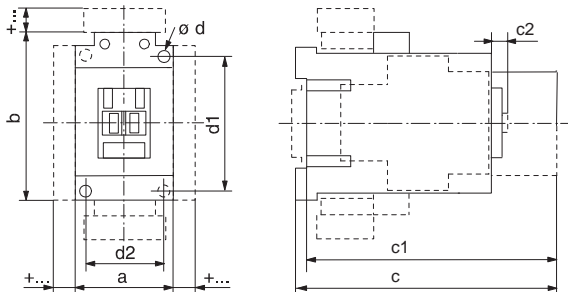


Figure 140 - Relay Dimensions



AC and DC Safety Control Relays with 12V or 24V DC Electronic Coil

Cat. No.	a	b	c	c1	c2	Ød	d1	d2
700S-CF	45	81	119.5	114.5	6	2 - 4.5	60	35
	(1-25/32)	(3-3/16)	(4-3/4)	(4-43/64)	(1/4)	(2 - 3/16)	(2-23/64)	(1-25/64)

DC Safety Control Relays with 48...72V, 110...125V or 220...250V DC Electronic Coil

Cat. No.	a	b	c	c1	c2	Ød	d1	d2
700S-CF	45	105	119.5	114.5	6	2 - 4.5	60	35
	(1-25/32)	(4-1/8)	(4-3/4)	(4-43/64)	(1/4)	(2 - 3/16)	(2-23/64)	(1-25/64)

DC Safety Control Relays with Conventional Coil

Cat. No.	a	b	c	c1	c2	Ød	d1	d2
700S-CF	45	81	145.5	140.5	6	2 - 4.5	60	35
	(1-25/32)	(3-3/16)	(5-49/64)	(5-37/64)	(1/4)	(2 - 3/16)	(2-23/64)	(1-25/64)

Accessories - 700S-CF Relays

Safety Control Relays with	mm	[in.]
Auxiliary contact block for side mounting 1- or 2-pole	a + 9	(a + 23/64)
Electronic Timing Module on coil terminal side	b + 24	(b + 15/16)
Interface Module on coil terminal side	b + 9	(b + 23/64)
Surge Suppressor on coil terminal side	b + 3	(b + 1/8)
Labeling with label sheet	+ 0	(+ 0)
Marking tag sheet with clear cover	+ 0	(+ 0)
Marking tag adapter for System Bul. 1492W	+ 5.5	(+ 7/32)

700-EF Control Relay

- IEC industrial relays
- Electronic coils
- Mechanically linked contact performance per IEC 60947-5-1
- Wide control voltage range
- Built-in surge protection
- Add-on auxiliary contact blocks - front or side mount



Product Selection

4-Pole AC Coil Voltage

AC-12	AC-15						Connection Diagrams	Contacts		Cat. No.
	I_e [A]							N.O.	N.C.	
I_{th} [A]										
≤ 40 °C	24/48V	120V	240V	400V	500V	690V				
16	6	6	4	3	2	2		2	2	700-EF220⊗
								3	1	700-EF310⊗
								4	0	700-EF400⊗

⊗ Coil Voltage Codes




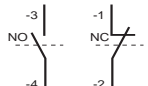
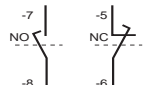

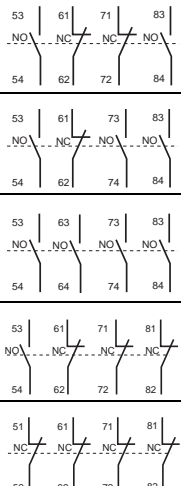

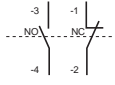
The Cat. No. as listed is incomplete. Select a coil voltage code from the table below to complete the cat. no. Example: Cat. No. 700-EF220⊗ becomes Cat. No. 700-EF220KJ.

[v] ⁽¹⁾	12...20V DC	24V DC	24...60V AC 20...60V DC	48...130V AC/DC	100...250V AC/DC	250...500V AC/DC
Standard AC/DC	—	—	KJ	KY	KD	KN
Low Consumption AC/DC	EQ	—	EJ	—	—	—
Low Consumption/Faster Drop-out DC	—	QJ	—	—	—	—




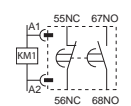
(1) AC Voltages are a 50/60 Hz.

Accessories


Auxiliary Contact Blocks with Standard Auxiliary Contacts

	Description			Connection Diagrams	For Use With	Cat. No.
		N.O.	N.C.			
 <p>Auxiliary Contact Blocks for Front Mounting</p> <ul style="list-style-type: none"> • 1-pole • Quick and easy mounting without tools • Screw connection terminals • Switching down to 12V, 3mA • Mirror contact performance to the main relay poles • L= Late break N.C./early make N.O. 		1	0		700-EF220⊗ 700-EF310⊗	100-EFA10
		0	1			100-EFA01
		1L	0		700-EF220⊗ 700-EF310⊗	100-EFAL10
		0	1L			100-EFAL01
 <p>Auxiliary Contact Blocks for Front Mounting</p> <ul style="list-style-type: none"> • 4-pole • Quick and easy mounting without tools • Screw connection terminals • Switching down to 12V 3mA • Mirror contact performance to the main relay poles 		2	2		700-EF220⊗	100-EFA22
		3	1			100-EFA31
		4	0			100-EFA40
		1	3			100-EFA13
		0	4			100-EFA04
 <p>Auxiliary Contact Blocks for Side Mounting</p> <ul style="list-style-type: none"> • 2-pole • Two-way numbering for right or left mounting on the relay • With or without sequence terminal designations • Quick and easy mounting without tools • Screw connecting terminals • Switching down to 12V, 3mA • Mirror contact performance to the main relay poles 		1	1		700-EF220⊗ 700-EF310⊗	100-ESA11


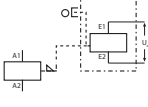
Electronic Timers

	Description				Connection Diagrams	For Use With	Cat. No.
			N.O.	N.C.			
 <p>Electronic Timing Module—ON-Delay</p> <ul style="list-style-type: none"> • Delay of the relay solenoid • The relay is energized at the end of the delay time 	ON-Delay	0.1...1 s 1...10 s 10...100 s	1	1		700-EF220⊗ 700-EF310⊗	100-ETA
	Electronic Timing Module—OFF-Delay <ul style="list-style-type: none"> • Delay of the relay solenoid • After interruption of the control signal, the relay is de-energized a the end of the delay time 	OFF-Delay	0.1...1 s 1...10 s 10...100 s	1			1


DC Interface Module

	Description	For Use With	Pkg. Qty.	Cat. No.
	DC Interface <ul style="list-style-type: none"> Receives 24V DC signals from PLCs or other low output power sources and switches AC control power to operate the coils of the relay. Coil voltage: 24...250V AC 50/60 Hz Rated control circuit voltage U_c: 24VDC 	700-EF	1	100-EJE
			10	100-EJEM


Mechanical Latch

	Description	Rated Voltage [V]		Connection Diagram	For Use With	Cat. No.
		V AC, 50/60 Hz	V DC			
	Mechanical Latch <ul style="list-style-type: none"> Ensures contactor or relay is switched on even if there is a voltage failure Opening controlled either electrically by AC or DC impulse or manually by button Front mounting 	24...60	24...60		700-EF	100-EFL11KJ
		48...130	48...130			100-EFL11KY
		100...250	100...250			100-EFL11KD
		250...500	250...500			100-EFL11KN

Additional Coil Terminal Block

	Description	For Use With	Pkg. Qty.	Cat. No.
	Additional Coil Terminal Block <ul style="list-style-type: none"> Allows bottom access to the coil terminals in addition to top access 	700-EF	10	100-ECT


Functional Markers

	Description	For Use With	Pkg. Qty.	Cat. No.
	Functional Markers <ul style="list-style-type: none"> 256 markers (16 per card) printable on HTP500 thermal transfer printer and AMS 500 marking table 7 x 20 mm (0.276 x 0.787 in.) 	700-EF	16	100-EFMS

Specifications

Table 144 - Auxiliary Contacts

Cat. No. 700-/700S-	Max 2 Pole Side Aux.	Max 1 Pole Front Aux.	Max 4 Pole Front Aux.	Timer	Mechanical Latch
EF310	1(L)	2	—	1	1
EF220	1(L)1(R)	4	1	1	1
EF400	—	—	—	—	—

	Location of welded N.O. contacts	State of N.C. Contacts if N.O. contact welds		
		Main	Front aux.	Side aux.
Mechanically Linked Contacts ⁽¹⁾	Main	Open	Open	Open ⁽²⁾
	Front aux.	Open	Open	—

(1) Side mounted auxiliary contacts provide "mirror contact" performance with main poles only.

(2) Defined in IEC 60947-5-1 annex L. Mechanically linked is a relationship between contacts of opposite types (i.e., N.O. and N.C.).


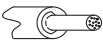
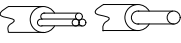


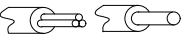
Table 145 - Contacts

			700-EF	100-EF	100-ESA
Switching of AC Loads					
Rated Insulation voltage U_i			690V	690V	690V
Rated operational voltage U_e			690V	690V	690V
Rated impulse withstand voltage U_{imp}			6kV	6kV	6kV
AC-12 I_{th}	at 40 °C	[A]	16	16	16
	at 60 °C	[A]	—	—	—
AC-15 at rated voltage of	24V	[A]	6	6	6
	42/48V	[A]	6	6	6
	120V	[A]	6	6	6
	230V	[A]	4	4	4
	240V	[A]	4	4	4
	400V	[A]	3	3	3
	415V	[A]	3	3	3
	500V	[A]	2	2	2
690V	[A]	2	2	2	
Switching of DC Loads					
DC-13 switching electromagnets at	24V DC	[A]	6	6	6
	48V DC	[A]	2.8	2.8	2.8
	110V DC	[A]	0.55	0.55	0.55
	220V DC	[A]	0.27	0.27	0.27
	440V DC	[A]	0.13	0.13	0.13
Fuse gG					
Load Carrying Capacity per UL/CSA					
Rated voltage	AC	[V]	600	600	600
Continuous rating	40 °C	[A]	10	10	10
Switching capacity	AC		A 600	A 600	A 600
Rated voltage	DC	[V]	600	600	600
Continuous rating	40 °C	[A]	2.5	2.5	2.5
Switching capacity	DC		Q 600	Q 600	Q 600

General Specifications - 700-EF Relays

		Cat. No. 700-EF
Rated Insulation Voltage U_i	IEC	690V
	UL; CSA	600V
Rated Impulse Strength U_{imp}		6 kV
Rated Voltage U_e	AC	24, 48, 120, 230, 400, 500, 690V
	DC	24, 48, 110, 220, 440V
Short-Circuit Protection gG Fuse		10 A
Rated Frequency		50/60 Hz, DC
Ambient Temperature	Storage	-60...+80 °C (-76...+176 °F)
	Operation at nominal current	-40...+70 °C (-40...+158 °F)
Altitude		3000 m
Mechanical Life		20 Mil
Electrical Life		1.5 Mil (AC-15 240V, 3A)
Type of Protection	IP2X (IEC 60529 and DIN 40050)	in connected state
Shock Resistance		IEC 60068-2: Half sinusoidal shock 11 ms, 25G (in 3 directions)
Vibration Resistance		IEC 60068-2: Static >2 G, in normal position no malfunction <5 G
Standards Compliance		UL 508, CSA C22.2 No. 14, EN/IEC 60947-1, -5-1, RoHS
Certifications		cULus Listed, CE Marked, CCC Certified

Table 146 - Conductor Cross Sections, Screw Type Terminals

700-EF/ 700S-EF			
Conductor Cross Sections—Main Contacts Terminal Type			 (1)
	1 conductor	[mm ²]	0.75...6
	2 conductors	[mm ²]	0.75...6
	1 conductor	[mm ²]	1...6
	2 conductors	[mm ²]	1...6
Recommended torque		[N•m]	1.5
Cross Section per UL/CSA		[AWG]	16...10
Recommended torque		[lb•in]	13
Conductor Cross Sections- Coil and Auxiliary Contact Terminal Type			 (1)
	1 conductor	[mm ²]	0.75...2.5
	2 conductors	[mm ²]	0.75...2.5
	1 conductor	[mm ²]	1...2.5
	2 conductors	[mm ²]	1...2.5
Recommended torque		[N•m]	1.2
Cross Section per UL/CSA		[AWG]	18...14
Recommended torque		[lb•in]	11

(1) Pozidriv No. 2 / Blade No. 3 screw.

Table 147 - Coil Data

700-EF/ 700S-EF			
Operating Limits			
50/60Hz	pick-up	[x Us]	0.85...1.1
	dropout	[x Us]	≤ 0.60
DC Control	pick-up	[x Us]	0.80...1.1
	dropout	[x Us]	≤ 0.60
Standard Coil			
24-60V AC, 20-60V DC (KJ)	pick-up	[VA]/[W]	50/50
	hold-in	[VA]/[W]	2.2/2
48...130V AC/DC (KY)	pick-up	[VA]/[W]	50/50
	hold-in	[VA]/[W]	2.2/2
100...250V AC/DC (KD)	pick-up	[VA]/[W]	50/50
	hold-in	[VA]/[W]	2.2/2
250...500V AC/DC (KN)	pick-up	[VA]/[W]	50/50
	hold-in	[VA]/[W]	2.2/2
Operating Times	closing delay	[ms]	40...95
	opening delay	[ms]	11...95
Energy-efficient Coil			
12-20V DC (EQ)	pick-up	[W]	12...16
	hold-in	[W]	1.7
24-60V AC, 20-60V DC (EJ)	pick-up	[VA]/[W]	16/12...16
	hold-in	[VA]/[W]	1.7/1.7
Operating Times	closing delay	[ms]	40...95
	opening delay	[ms]	11...95
High Energy Efficient Coil			
24V DC (QJ)	pick-up	[W]	6
	hold-in	[W]	1.7
Operating Times	closing delay	[ms]	27...53
	opening delay	[ms]	17...29

Table 148 - Contact Rating Table from EN 60947-5-1: Examples of Contact Rating Designation Based on Utilization Categories

NEMA Designation ⁽¹⁾	IEC Utilization Category	Conventional Thermal Current I_{the} [A]	Rated Operational Current I_e (A) at Rated Operational Voltage U_e						VA Rating	
			120V	240V	380V	480V	500V	600V	Make	Break
AC										
A150	AC-15	10	6	—	—	—	—	—	7200	720
A300	AC-15	10	6	3	—	—	—	—	7200	720
A600	AC-15	10	6	3	1.9	1.5	1.4	1.2	7200	720
B150	AC-15	5	3	—	—	—	—	—	3600	360
B300	AC-15	5	3	1.5	—	—	—	—	3600	360
B600	AC-15	5	3	1.5	0.95	0.75	0.72	0.6	3600	360
C150	AC-15	2.5	1.5	—	—	—	—	—	1800	180
C300	AC-15	2.5	1.5	0.75	—	—	—	—	1800	180
C600	AC-15	2.5	1.5	0.75	0.47	0.375	.035	0.3	1800	180
D150	AC-15	1.0	0.6	—	—	—	—	—	432	72
D300	AC-14	1.0	0.6	0.3	—	—	—	—	432	72
E150	AC-14	0.5	0.3	—	—	—	—	—	216	36

Table 148 - Contact Rating Table from EN 60947-5-1: Examples of Contact Rating Designation Based on Utilization Categories

NEMA Designation ⁽¹⁾	IEC Utilization Category	Conventional Thermal Current I_{the} [A]	Rated Operational Current I_e (A) at Rated Operational Voltage U_e						VA Rating	
			125V	250V	440V	500V	600V	—	Make	Break
DC										
N150	DC-13	10	2.2	—	—	—	—	—	275	275
N300	DC-13	10	2.2	1.1	—	—	—	—	275	275
N600	DC-13	10	2.2	1.1	0.63	0.55	0.4	—	275	275
P150	DC-13	5	1.1	—	—	—	—	—	138	138
P300	DC-13	5	1.1	0.55	—	—	—	—	138	138
P600	DC-13	5	1.1	0.55	0.31	0.27	0.2	—	138	138
Q150	DC-13	2.5	0.55	—	—	—	—	—	69	69
Q300	DC-13	2.5	0.55	0.27	—	—	—	—	69	69
Q600	DC-13	2.5	0.55	0.27	0.15	0.13	0.1	—	69	69
R150	DC-13	1.0	0.22	—	—	—	—	—	28	28
R300	DC-13	1.0	0.22	0.1	—	—	—	—	28	28

(1) This letter stands for the conventional thermal current and identifies AC or DC: for example, B=5 A AC. The number that follows is the rated insulation voltage.

Approximate Dimensions

Dimensions are shown in millimeters (inches). Dimensions are not intended for manufacturing purposes.

Figure 141 - Mounting Position 700-EF Relays

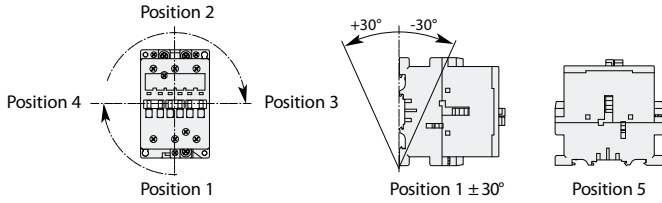


Figure 142 - 700-EF Relays with Standard Coils

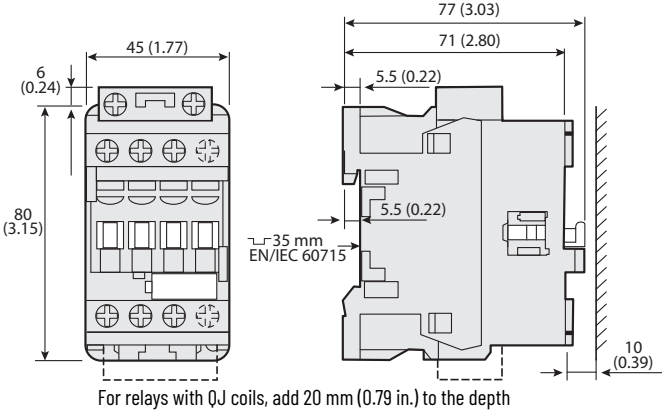


Figure 143 - 700-EF Relays with Low-consumption Coils

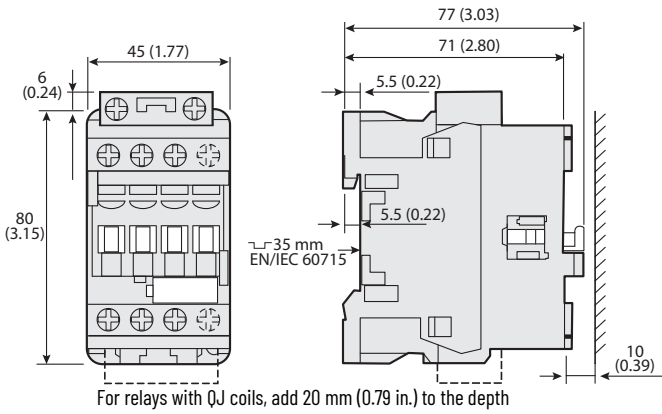


Figure 144 - 700-EF Relays with Standard Coils and Front-mounted Auxiliary Contact

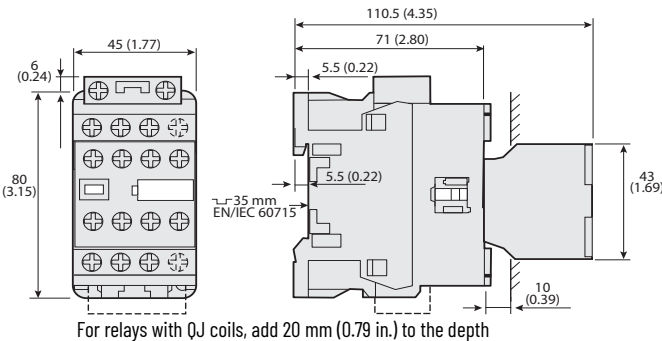


Figure 145 - 700-EF Relays with Standard Coils and Side-mounted Auxiliary Contact

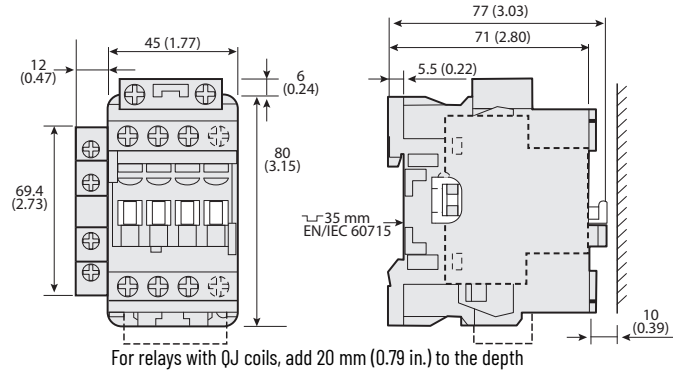


Figure 146 - 700-EF Relays with Low-consumption Coils and Front-mounted Auxiliary Contact

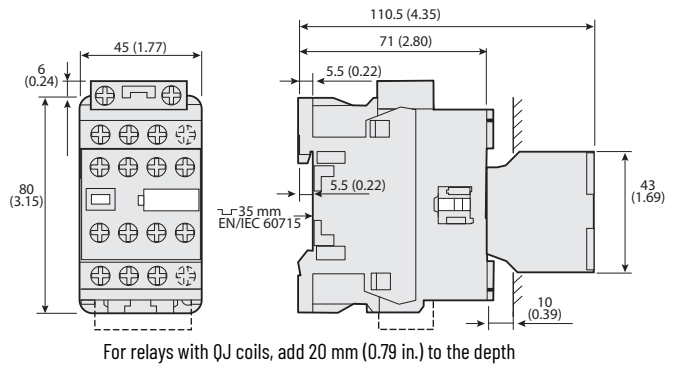
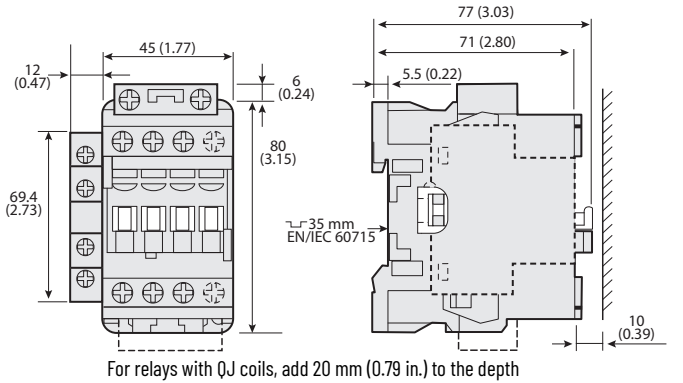


Figure 147 - 700-EF Relays with Low-consumption Coils and Side-mounted Auxiliary Contact




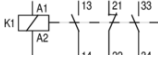
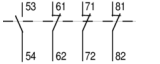
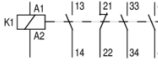
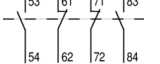
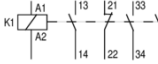

700S-EF Control Relays

The 700S-EF Safety Control Relay provides mechanically or mirror contact performance, which are required in feedback circuits for safety applications.



- IEC industrial safety relay
- Electronic coils
- Mechanically linked contacts as per IEC 60947-5-1
- Red cover and mechanically linked contact symbol on front face
- Permanently fixed front mounted auxiliary contact block

Product Selection

AC-12		AC-15						Connection Diagrams		Contacts		Cat. No.
I_{th} [A]		I_e [A]						Main Contacts	Auxiliary Contacts			
40 °C		24/48V	120V	240V	400V	500V	690V			N.O.	N.C.	
Main Contacts	16	6	6	4	3	2	2			4	4	
										5	3	700S-EF530⊗C
Adder Deck Contacts	16	6	6	4	3	2	2			6	2	700S-EF620⊗C

⊗ Coil Voltage Codes

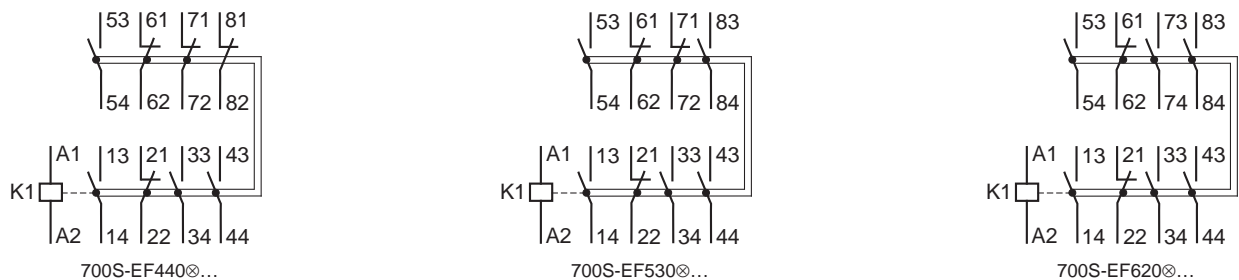
The Cat. No. as listed is incomplete. Select a coil voltage code from the table below to complete the cat. no. Example: Cat. No. 700-EF220⊗ becomes Cat. No. 700-EF220KJ.

[v] ⁽¹⁾	12...20V DC	24V DC	24...60V AC 20...60V DC	48...130V AC/DC	100...250V AC/DC	250...500V AC/DC
Standard AC/DC	—	—	KJ	KY	KD	KN
Low Consumption AC/DC	EQ	—	EJ	—	—	—
Low Consumption/Faster Drop-out DC	—	QJ	—	—	—	—

(1) AC Voltages are a 50/60 Hz.


Assignment of Contacts

Figure 148 - Safety Control Relays with Front-mount Auxiliary Contacts, 8-Pole AC or DC Coil Voltage




Accessories

Additional Coil Terminal Block

	Description	For Use With	Pkg. Qty.	Cat. No.
	Additional Coil Terminal Block <ul style="list-style-type: none"> Allows bottom access to the coil terminals in addition to top access 	700-EF	10	100-ECT

Marking Systems


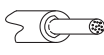
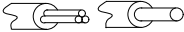

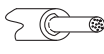
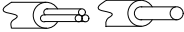
	Description	For Use With	Pkg. Qty.	Cat. No.
	Functional Markers <ul style="list-style-type: none"> 256 markers (16 per card) printable on HTP500 thermal transfer printer and AMS 500 marking table 7 x 20 mm (0.276 x 0.787 in) 	700-EF	16	100-EFMS

Specifications

See [Specifications on page 210](#) for additional 700S-EF specifications.

		Cat. No. 700S-EF	Aux. Contact (Front-mounted)
Mechanical Life	[Mil]	20	20
Electrical Life	AC-15 (240V, 3 A) [Mil]	1.5	1.5
Standards Compliance	UL 508, CSA C22.2 No. 14, EN/IEC 60947-1, -5-1, Meets the material restrictions for European Directive 2002/95/EC - EU-RoHS		
Certifications	cULus Listed , CE Marked, CCC Certified		

Table 149 - Conductor Cross Sections, Screw Type Terminals

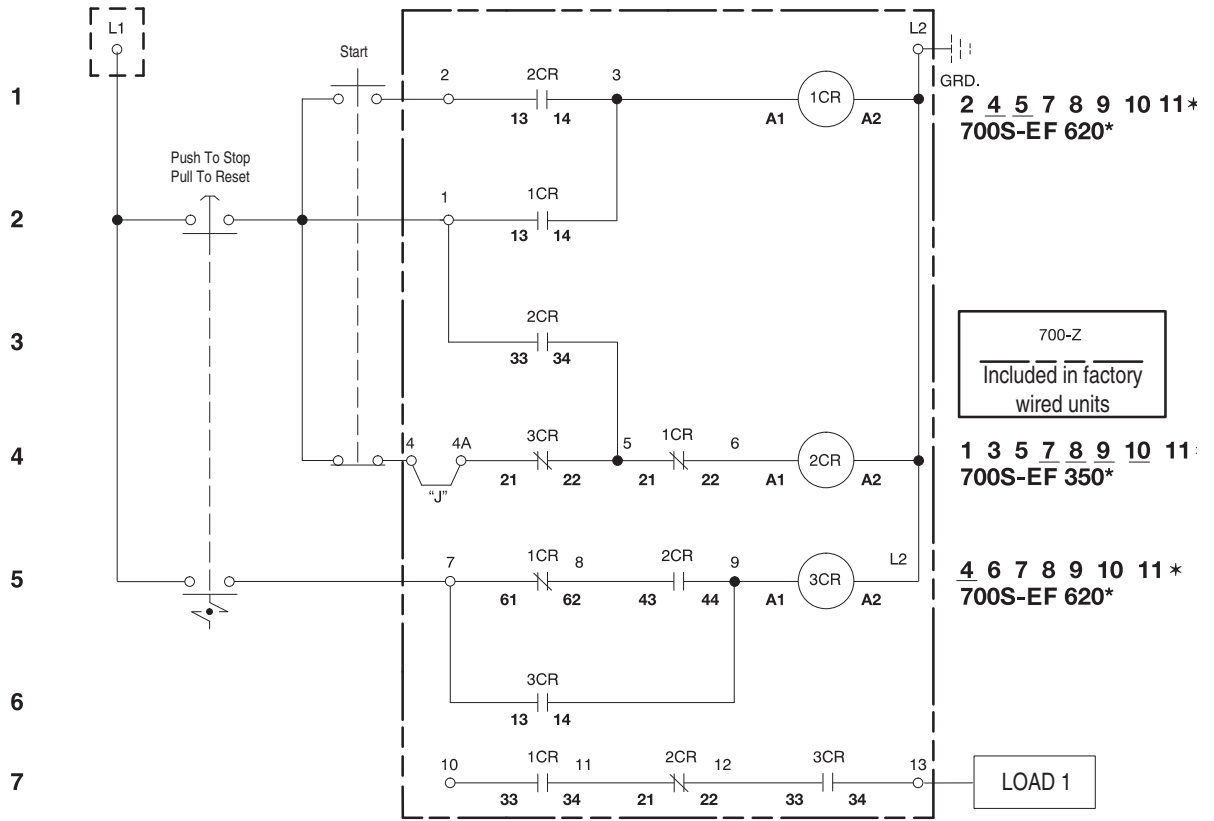
700-EF/ 700S-EF			
Conductor Cross Sections—Main Contacts Terminal Type			 (1)
	1 conductor	[mm ²]	0.75...6
	2 conductors	[mm ²]	0.75...6
	1 conductor	[mm ²]	1...6
	2 conductors	[mm ²]	1...6
Recommended torque		[N•m]	1.5
Cross Section per UL/CSA		[AWG]	16...10
Recommended torque		[lb-in]	13
Conductor Cross Sections- Coil and Auxiliary Contact Terminal Type			 (1)
	1 conductor	[mm ²]	0.75...2.5
	2 conductors	[mm ²]	0.75...2.5
	1 conductor	[mm ²]	1...2.5
	2 conductors	[mm ²]	1...2.5
Recommended torque		[N•m]	1.2
Cross Section per UL/CSA		[AWG]	18...14
Recommended torque		[lb-in]	11

(1) Pozidriv No. 2 / Blade No. 3 screw.

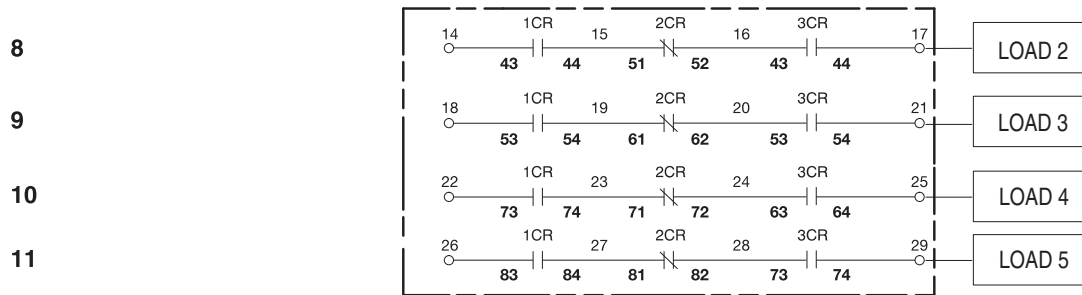
Safety Relay Circuit With 5 Safety Outputs

- Use for E-stop control. E-stop will work properly if any one fault occurs (a fault could be one welded contact or one undesired open connection such as a loose wire).
- High output switching capability and long contact life.
- Circuit complies with EN 954 categories 1, 2, 3, 4.
- Helps prevent restart of the 5 safety outputs if there is a single fault anywhere in the system.
- Use three 700S-EF relays and [Figure 149](#) to construct the circuit.

Figure 149 - 700S-EF Circuit



(5) Output Circuit (3 Relays, 17 Terminal Blocks)



Approximate Dimensions

Dimensions are shown in millimeters (inches). Dimensions are not intended for manufacturing purposes.

Figure 150 - Mounting Position for 700S-EF Relays

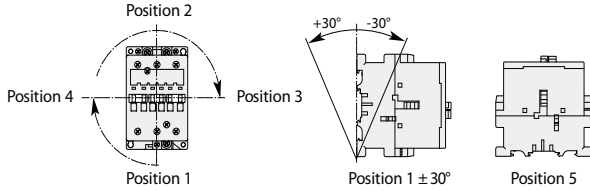


Figure 151 - 700S-EF Relays with Standard Coils and Front-mounted Auxiliary Contact

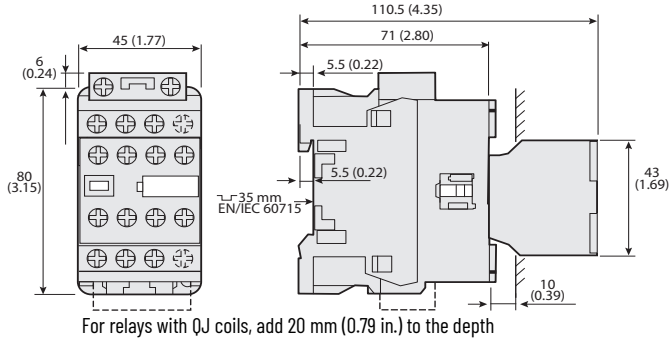
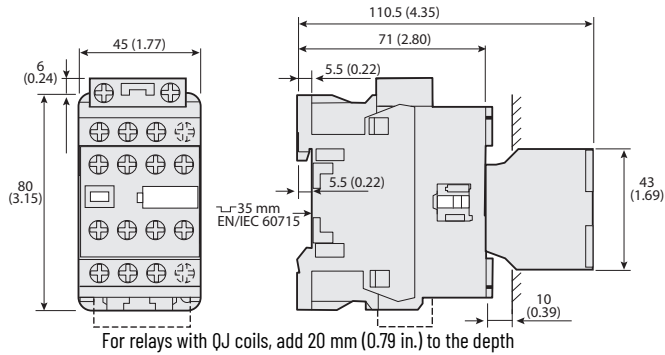


Figure 152 - 700S-EF Relays with Low-consumption Coils and Front-mounted Auxiliary Contact



700-K Miniature Control Relays

- IEC compact industrial relay
- IP2X Finger Protection
- Bifurcated contacts for low-level signals
- Optional integrated coil protection diode



Product Selection

4-Pole AC or DC Coil Voltage

AC-12		AC-15 (B600)							Diagrams	Contacts		Pkg. Qty. (1)	Cat. No.
I_{th} [A]		I_e [A]								N.O.	N.C.		
40 °C	60 °C	24/48V	120V	240V	400V	500V	600V	690V					
10	6	3	3	2	1	1	0.6	0.6		4	0	1	700-K40E-⊗
										3	1	1	700-K31Z-⊗
										2	2	1	700-K22Z-⊗
										1+1L (2)	1+1L	1	700-KL22Z-⊗

(1) May be ordered in package quantities of 20. Add letter M to the end of the cat. no. Example: 700-K40E-ZJM.

(2) 1L = Late Break N.C. / Early Make N.O.

⊗ Coil Voltage Codes

The Cat. No. as listed is incomplete. Select a coil voltage code from the table below to complete the cat. no. Example: Cat. No. 700-K40E-⊗ becomes Cat. No. 700-K40E-KF. For other voltages, consult your local Rockwell Automation sales office or Allen-Bradley distributor.

Screw type terminal versions

AC Voltages [V]	24	110	120	230	240	400	480	600	DC Voltages [V]	12	24	110	125	220	250
50 Hz	—	D	—	—	—	—	—	—	Standard	ZQ	ZJ	ZD	ZS	ZA	ZT
60 Hz	—	—	D	—	—	—	B	VC	with Integrated Diode	—	DJ	—	—	—	—
50/60 Hz	KJ	—	—	KF	KA	KN	—	—							

Spring clamp type terminal versions

AC Voltages [V]	24	110	120	230	DC Voltages [V]	24	110
50 Hz	—	D	—	—	Standard	ZJ	ZD
60 Hz	—	—	D	—	with Integrated Diode	DJ	—
50/60 Hz	KJ	—	—	KF			

Assignment of Contacts

Table valid for: AC / DC = 0.85...1.1 x U_s, T_{amb.} = -25 °C...+60 °C (-13...140 °F), normal position (horizontal rail mounting) Also valid for 700-KR relays and 100-KR auxiliary contacts. ⁽³⁾

Device Combinations in Accordance with IEC 60947-1 / -4-1












Auxiliary Contact Blocks		Control Relays 700-K (AC and DC Control)				
Cat. No.	Circuit Diagram	Control	700-K22Z-	700-K31Z-	700-K40E-	700-KL22Z-
Front Mounting						
100-KFA02E		AC/DC	—	31Z + 02E = 33Y ⁽¹⁾	40E + 02E = 42Y	—
100-KFA11E		AC/DC	22Z + 11E = 33Y	31Z + 11E = 42Y	40E + 11E = 51Y	L22Z + 11E = L33Y
100-KFA20E		AC/DC	22Z + 20E = 42Y	31Z + 20E = 51Y	40E + 20E = 60Y	L22Z + 20E = L42Y
100-KFA04E		AC/DC	—	—	40E + 04E = 44Y ⁽¹⁾	—
100-KFA13E		AC/DC	—	31Z + 13E = 44Y ⁽¹⁾	40E + 13E = 53Y	—
100-KFA22Z		AC/DC	—	31Z + 22Z = 53Y ⁽¹⁾	40E + 22Z = 62Y	—
100-KFA31Z		AC/DC	—	—	40E + 31Z = 71Y ⁽²⁾	—
100-KFA40E		AC/DC	22Z + 40E = 62Y	31Z + 40E = 71Y	40E + 40E = 80Y	L22Z + 40E = L62Y

(1) T_{amb.} max. +40 °C (104 °F)

(2) T_{amb.} max. +40 °C (104 °F) and only allowed for coil voltage 24V DC or 230V AC




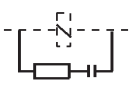
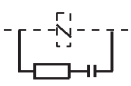
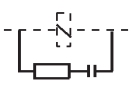
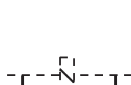
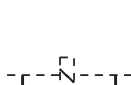
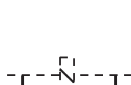
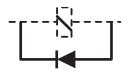
Accessories

Auxiliary Contact Blocks

	Description	Connection Diagrams			For Use With	Pkg. Qty. (1)	Screw Type Terminals	Spring Clamp Terminals
			N.O.	N.C.			Cat. No.	Cat. No.
	Front-mounted auxiliary contacts <ul style="list-style-type: none"> • Auxiliary Contact Blocks • 2- and 4-pole versions • Choice of contact configurations • Snap on, no tools required • Electronic-compatible bifurcated contacts for signals down to 15V / 2 mA 		0	2	100/104-K, 700-K	1	100-KFA02E	100-KRFA02E
			1	1	100/104-K, 700-K	1	100-KFA11E	100-KRFA11E
			2	0	100/104-K, 700-K	1	100-KFA20E	100-KRFA20E
		0	4	100/104-K, 700-K	1	100-KFA04E	100-KRFA04E	
		1	3	100/104-K, 700-K	1	100-KFA13E	100-KRFA13E	
		2	2	100/104-K, 700-K	1	100-KFA22Z	100-KRFA22Z	
		3	1	100/104-K, 700-K	1	100-KFA31Z	100-KRFA31Z	
	4	0	100/104-K, 700-K	1	100-KFA40E	100-KRFA40E		




(1) May be ordered in package quantities of 10. Add letter **M** to the end of the cat. no. Example: **100-KFA02EM**.

Control Modules

Photo	Description	Connection Diagrams	For Use With	Pkg. Qty.	Cat. No.
	Mechanical Interlock <ul style="list-style-type: none"> • For interlocking of two adjacent contactors • No added width to contactor assembly • Front mount plug-in type • Optional auxiliary contact blocks and suppressor modules mount onto the interlock 		100/104-K/- KR, 700-K/- KR	1	100-KMCH
	RC Suppressor		100/104-K/- KR, 700-K/- KR	1 ⁽¹⁾	100-KFSC50
				1 ⁽¹⁾	100-KFSC280
				1 ⁽¹⁾	100-KFSC480
	MOV Suppressor		100/104-K/- KR, 700-K/- KR	1 ⁽¹⁾	100-KFSV55
				1 ⁽¹⁾	100-KFSV136
				1 ⁽¹⁾	100-KFSV277
Diode Suppressor		100/104-K/- KR, 700-K/- KR	1 ⁽¹⁾	100-KFSD250	

(1) May be ordered in package quantities of 10. Add letter **M** to the end of the cat. no. Example: **100-KFSC50M**.

Marking Systems

	Description	Pkg. Qty.	Cat. No.
	Label Sheet • 105 self-adhesive paper labels each, 6 x 17 mm (0.236 x 0.67 in)	10	100-FMS
	Adhesive labels • Each label 6 x 17 mm (0.236 x 0.67 in) • White, halogen-free polyester, with acrylate adhesive • Ambient temperature range -40...+120 °C (-40...+248 °F) • Qty: 3000/roll	Ribbon: Cat. No. 1492-PRILAB Roller: Cat. No. 1492-PROLLLAB 1	1492-MDM6X17-W
	Marking Tag • Each tag 6 x 12 mm (0.236 x 0.472 in) • White, PC-ABS, TPU, halogen-free, clip-in foot • Ambient temperature range -50...+90 °C (-58...+194 °F) • Qty: 600/roll	Ribbon: Cat. No. 1492-PRIBTB Roller: Cat. No. 1492-PROLLTB 1	1492-MT6X12

Specifications



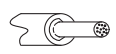
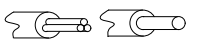
Table 150 - Main Circuits

			700-K	700-KR
AC-12 Rated Thermal Current Ambient temperature 40°C	I_{th}	24...240V	[A]	10
		230...500V	[A]	10
		230...690V	[A]	10
Ambient temperature 60°C	I_{th}	24...240V	[A]	6
		230...500V	[A]	6
		230...690V	[A]	6
AC-15/B600 Switching of Solenoids and contactors	I_e	24V	[A]	3
		48V	[A]	3
		120V	[A]	3
		230V	[A]	2
		240V	[A]	2
		400V	[A]	1.2
		480V	[A]	1
		500V	[A]	1
		600V	[A]	0.6
690V	[A]	0.6		
Short-circuit Protection		Fuse gG	[A]	10
Min. Switching Capacity 15V			[mA]	2
Resistance and Power Dissipation				
Main current circuit resistance, 1 pole			[mΩ]	6.5
Power dissipation, 4 poles			[W]	2.6
Total power dissipation	AC control, warm		[W]	4.4
	DC control, warm		[W]	5.2
Lifespan	Mechanical		[Mil. op.]	15
	Electrical AC-15 (240V / 2 A)		[Ml. op.]	0.7
Weight	AC control		[kg (lbs.)]	0.16 (0.35)
	DC control		[kg (lbs.)]	0.2 (0.44)
Load Carrying Capacity per UL/CSA	Rated voltage	AC	[V]	max. 600
	Continuous rating	40 °C	[A]	10 6
	Switching capacity	AC	[A]	B 600
	Rated voltage	DC	[V]	max. 600
	Switching capacity	DC	[A]	0 600

Table 151 - DC-13/Q600

			700-K
1 pole	24V	[A]	2.3
	48V	[A]	1
	110V	[A]	0.55
	125V	[A]	0.55
	220V	[A]	0.27
	250V	[A]	0.27
	400V	[A]	0.15
	440V	[A]	0.15
	600V	[A]	0.1

Table 152 - Conductor Cross Sections - Main Contacts, Auxiliary Contacts, and Coil Terminals

				700-K	700-KR
Terminal type				(1) 	
	Fine stranded with ferrule	(1) Conductor (2) Conductors	[mm ²]	0.75...2.5 0.75...2.5	0.50...2.5 0.50...2.5
	Solid or coarse stranded	(1) Conductor (2) Conductors	[mm ²]	1...4 1...2.5 + 1...4	0.75...2.5 ⁽²⁾ 0.75...2.5 ⁽²⁾
Recommended torque			[N•m]	1.2	—
Cross section per UL/CSA			[AWG]	18...12 ⁽³⁾	18...14 ⁽²⁾
Recommended torque			[lb•in]	10.6	—

(1) Pozidriv No. 2 / Blade No. 3 screw.

(2) Stranded wire only.

(3) Use same cross sections.

Table 153 - Coil Data

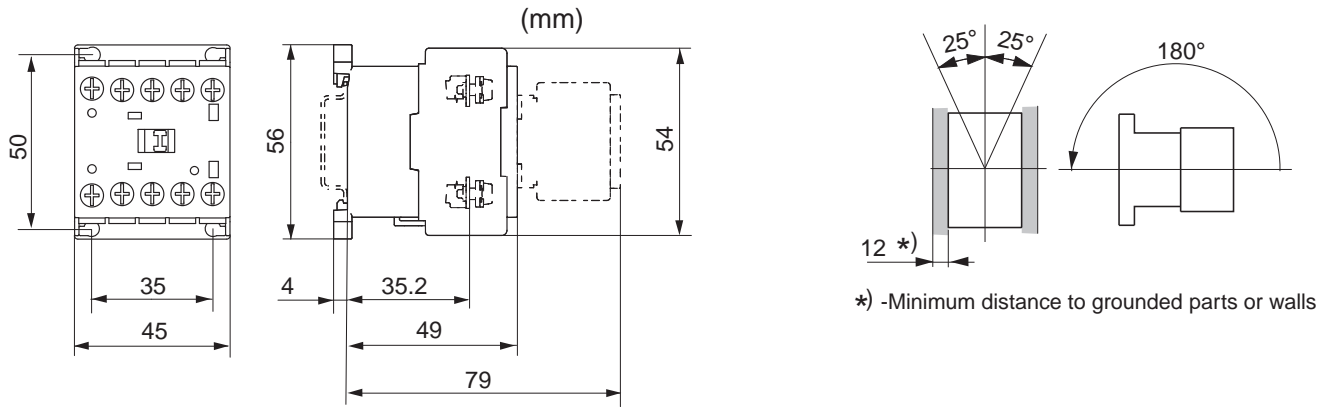
			700-K
Operating Limits			
50 Hz, 60 Hz, 50/60 Hz	pick-up	[x U _s]	0.85...1.1
	dropout	[x U _s]	0.2...0.75
DC (conventional)	pick-up	[x U _s]	0.8...1.1 0.7...1.25 ⁽¹⁾
	dropout	[x U _s]	0.1...0.75
Coil Consumption			
50 Hz, 60 Hz, 50/60 Hz	pick-up	[VA]	35
	hold-in	[VA/W]	5/1.8
DC (conventional)	pick-up	[W]	cold 3.0, warm 2.6
	hold-in	[W]	cold 3.0, warm 2.6
Operating Times			
AC	closing delay	[ms]	15...40
	opening delay	[ms]	15...33
With RC module	closing delay	[ms]	15...28
DC (conventional)	opening delay	[ms]	18...40
	closing delay	[ms]	6...12
With integrated diode	opening delay	[ms]	8...12
With external diode	opening delay	[ms]	35...50

(1) For 9, 12, 24, and 110V DC coils

Approximate Dimensions

Approximate dimensions are shown in millimeters. To convert millimeters to inches multiply by 0.0394. Dimensions are not intended to be used for manufacturing purposes.

Figure 153 - 700-K Control Relay and Mounting Position



Product Overview

				
Bulletin No.	700-SA		700-SC	
Type	Tube Base, Socketed		Miniature, Ice Cube Socketed	
Features	Compatible with 700-HN100, 125,108, and 204 socket, LED status, zero-cross switching		Compatible with 700-HN103 or 128 socket, LED Status, and Zero-cross AC Switching Options	
Load Type	AC (47...63 Hz)	DC	AC (47...63 Hz)	DC
Load Voltage Range	75...264V AC	3...125V DC	75...264V AC	3...52.8V DC or 3...125V DC
Load Current Max. (Continuous)	5 A	3 A	3 A	3 A @ 48V DC or 2 A @ 110V DC
Max. Leakage Current to Load	5 mA @ 100V, 10 mA @ 200V	5 mA @ 125V	5 mA @ 100V AC	10 mA @ 200V AC, 5 mA @ 50V DC or 0.1 mA @ 100V DC
Zero Cross Load Switching	Yes	Not Applicable	Yes (optional)	Not Applicable
Equivalent Electromechanical Relay Contact Arrangement	Form A		Form A	
Rated Control (Input) Voltage	5...24V DC		5...24V DC, 100...110V AC, 200/220V AC	5...24V DC
LED Indicator	Yes		Yes (optional)	Yes (optional for 48V DC)
Mounting Method	Panel or DIN with socket		Panel or DIN with socket	
Dielectric Strength	1500V AC, 50/60 Hz, 1 min.		1500V AC, 50/60 Hz, 1 min.	
Certification	cURus, CE, VDE		cURus, CE, VDE	
Max. Ambient Operating Temperature	-30...+80 °C (no condensation)		-30...+80 °C (no condensation)	
Page	229		233	

							
Bulletin No.	700-SF		700-SH	700-SK			
Type	Square Base, Socketed		Hockey Puck	Slim Line, Socketed			
Features ⁽¹⁾	Compatible with 700-HN116 socket, LED status, zero-cross AC switching		Panel/DIN Mount, High Current, Protective Cover, LED Status	Compatible with 700-HN121 socket. Supports Input (sensor) module or Output (SSR) module			
Load Type	AC (47...63 Hz)	DC	AC (47...63 Hz) 3...60V DC	Output Module		Input Module	
				AC (47...63 Hz)	DC	AC (47...63 Hz)	DC
Load Voltage Range	75...264V AC	3 ... 52.8V DC	3...50V DC, 24...265V AC 42...530V AC, 42...265V AC, 42...660V AC	75 ... 264V AC	4 ... 60V DC, 40 ... 200V DC	Field Input: 60... 264V AC	Field Input: 6.6... 32V DC
Load Current Max. (Continuous)	3 A		10 A/100 A†	2 A	2 A @ 60V, 1.5 A @ 200V	Supply Current: 0.1...100 mA	Supply Current: 0.1...100 mA
Max. Leakage Current to Load	5 mA @ 100V AC, 10 mA @ 200V AC	5 mA @ 50V DC	<3 mA	1.5 mA	1 mA	5 µA	5 µA
Zero Cross Load Switching	Yes	Not Applicable	Yes	Yes (optional)	N/A	No	N/A
Equivalent Electromechanical Relay Contact Arrangement	Form A		Form A	Form A			
Rated Control (Input) Voltage	4V DC or 24V DC		3...32V DC, 4...32V DC, 80...130V AC, 20...260V AC 20...280V AC/22...48V DC	5... 24 V DC			
LED Indicator	Yes		Yes	Yes			
Mounting Method	Panel or DIN with socket		Panel without heat sink, Panel, or DIN with heat sink	Panel or DIN with socket			
Dielectric Strength	1500V AC, 50/60 Hz, 1 min.		>4000V AC RMS	4000V AC, 50/60 Hz, 1 min.			
Certification	cURus, CE, VDE		cURus, CE, CSA	cURus, CE, TÜV			
Max. Ambient Operating Temperature	-30...+80 °C (no condensation)		-20...+70 °C (no condensation)	-30...+80 °C (no condensation)			
Page	238		242	253			

(1) See [Table 154](#) for term definitions.

Table 154 - Solid-state Relay Glossary

Terms		Meaning
Insulation	Basic insulation	Insulation for basic protection from electric shock (IEC950 1.2.9.2)
	Supplemental insulation	Independent insulation that is provided outside of basic insulation to protect from electric shock when the basic insulation breaks down (IEC950 1.2.9.3)
	Reinforced insulation	A single-layer of insulation (IEC950 1.2.9.5) that provides the same protection from electric shock as double insulation, including both basic and supplemental insulation) according to conditions stipulated in IEC950 standards
Circuit functions	Zero cross circuit	A circuit that starts operation with the AC load voltage at close to zero-phase.
	Trigger circuit	A circuit for controlling the triac or thyristor trigger signal, which turns the load current ON and OFF.
Input	Isolated input circuit	If the external circuit is prone to generating noise, or if wires from external sources are prone to the influence of inductive noise, in order to prevent malfunctions due to noise, it is necessary to electrically isolate internal circuits and external circuits (output circuits). An isolated input circuit is a circuit that isolates inputs and outputs by using components that are not connected electrically but that can transmit signals, such as contact relays or photocouplers.
	Photocoupler	A component that runs the electric signal into a light emitter (for example, LED), changes it to a light signal, and then returns it to an electric signal using a photoelectric conversion element, such as a photo transistor. The space that is used for transferring the light signal is isolated thus providing good insulation and a high propagation speed.
	Rated voltage	The voltage that serves as the standard value of an input signal voltage
	Pickup (must-operate) voltage	Minimum input voltage when the output status changes from OFF to ON.
	Input impedance	The impedance of the input circuit and the resistance of current-limiting resistors used. Impedance varies with the input signal voltage in case of the constant current input method.
	Operating voltage	The permissible voltage range within which the voltage of an input signal voltage may fluctuate.
	Dropout (Reset) voltage	Maximum input voltage when the output status changes from ON to OFF.
	Input current	The current value when the rated voltage is applied.
Output	Load voltage	This is the effective value for the power supply voltage that can be used for load switching or in the continuous-OFF state.
	Maximum load current (continuous)	The effective value of the maximum current that can continuously flow into the output terminals under specified cooling conditions (i.e., the size, materials, thickness of the heat sink, and an ambient temperature radiating condition).
	Leakage current	The effective value of the current that can flow into the output terminals when a specified load voltage is applied to the SSR with the output turned OFF.
	Output ON voltage drop	The effective value of the AC voltage that appears across the output terminals when the maximum load current flows through the SSR under specified cooling conditions (such as the size, material, and thickness of heat sink, ambient temperature radiation conditions, etc.).
	Minimum load current (continuous)	The minimum load current at which the SSR can operate normally.
	Snubber circuit	A circuit consisting of a resistor R and capacitor C, which prevents faulty ignition from occurring in the SSR triac by suppressing a sudden rise in the voltage that is applied to the triac.
	Semiconductor output element (switching element)	This is a generic name for semiconductors such as the thyristor, triac, power transistor, and power MOS FET. In particular, triacs are often used in SSRs because they allow switching to be performed with one element.
	Repetitive peak OFF-state voltage (VDRM)	This is a rating for an output semiconductor that used in an SSR for AC loads.
	Collector-emitter voltage (VCEO)	This is a rating for an output semiconductor that used in an SSR for DC loads.
Characteristics	Operating (pick-up) time	A time lag between the moment a specified signal voltage is imposed to the input terminals and the output is turned ON.
	Release (drop-out) time	A time lag between the moment the imposed signal input is turned OFF and the output is turned OFF.
	Insulation resistance	The resistance between the input and output terminals or I/O terminals and metal housing (heat sink) when DC voltage is imposed.
	Dielectric strength	The effective AC voltage that the SSR can withstand when it is applied between the input terminals and output terminals or I/O terminals and metal housing (heat sink) for more than 1 minute.
	Ambient temperature and humidity (operating)	The ranges of temperature and humidity in which the SSR can operate normally under specified cooling, input/output voltage, and current conditions.
	Storage temperature	The temperature range in which the SSR can be stored without voltage imposition.
Others	Inrush current resistance	A current, which can be applied for short periods of time to the electrical element.
	Counter-electromotive force	Extremely steep voltage rise which occurs when the load switched or turned OFF.
	Recommended applicable load	The recommended load capacity which takes into account the safety factors of ambient temperature and inrush current.
	Bleeder resistance	The resistance connected in parallel to the load in order to increase apparently small load currents, so that the ON/OFF of minute currents functions normally. (It is also used to shunt leakage currents.)

Figure 154 - Solid-state Relay Switching Capacity

Relay Type	Equivalent EM Relay Contact Configuration	Load Voltage	Zero-Cross	Load Switching Device	Maximum AC and DC Switching Capability														
					1 mA	10 mA	50 mA	100 mA	1 A	3 A	5 A	10 A	20 A	25 A	30 A	35 A	100 A		
Solid-State	700-SA	Form A	AC	Yes	Triac					100 mA	1 A	3 A	5 A						
			DC	N/A	Transistor					100 mA	1 A	3 A							
	700-SC	Form A	AC	Yes	Triac					100 mA	1 A	3 A							
			DC	N/A	Transistor					100 mA	1 A	2 A							
	700-SF	Form A	AC	Yes	Triac					100 mA	1 A	3 A							
			DC	N/A	Transistor					100 mA	1 A	3 A							
	700-SH *	Form A	AC	Yes	Thyristor or Triac					100 mA	1 A	3 A	5 A	10 A	20 A	25 A	30 A	35 A	100 A
			DC	N/A	Transistor					100 mA	1 A	3 A							
	700-S KO	Form A	AC	Yes	Triac					100 mA	1 A	3 A							
			DC	N/A	Transistor					100 mA	1 A	2 A							

IMPORTANT * Requires a heat sink to reach maximum current value.

700-SA Tube Base Relays

- 5 A (resistive) max. continuous load (output) current
- 264V AC or 125V DC max. load voltage options
- Photocoupler isolation between control and load voltage
- LED indicator (standard) for input/logic ON/OFF status monitoring
- 700-HN100, -HN125, -HN 202, or -HN108 specialty socket compatible
- 700-HT2 timing module









Product Selection

Input-to-Output Isolation Method	Zero Cross Function	Status Indicator	Output (Load) Max. Continuous Current and Rated Voltage Range	Rated Input (Control) Voltage	Cat. No.
Photocoupler	Yes	Yes	5 A @ 100...240V AC (47...63 Hz)	5...24V DC	700-SAZY5Z25
	Not Applicable		3 A @ 5...110V DC		700-SANY3Z25

Accessories

Sockets and DIN Rail

	Description		For Use With	Pkg. Qty.	Cat. No.
	Screw Terminal Tube Base Socket <ul style="list-style-type: none"> • Panel or DIN Rail Mounting • 8-Pin 	<ul style="list-style-type: none"> • Guarded Terminal Construction 	DPDT 700-HA Relays -HX Timing Relays -HT (On-delay) Timing Relays -HRM, -HRC and -HV (Repeat Cycle) Timing Relays	10	700-HN100
					
	Specialty Socket <ul style="list-style-type: none"> • Backwired socket with solder terminals • Order 10 or multiples of 10. 	8-pin	700-SA Relays	10	700-HN108
	Socket <ul style="list-style-type: none"> • Can Be Used With or Without Timing Attachment or Surge Suppressor • Screw Terminal Tube Base Sockets • Panel or DIN Rail mounting • Guarded terminal construction 	8-Pin	DPDT Relays	10	700-HN204
	DIN (#3) symmetrical hat rail <ul style="list-style-type: none"> • 35 x 7.5 x 1 m 			10	199-DR1
	Retainer Clip <ul style="list-style-type: none"> • Secures relay in socket • Order must be for 10 clips or multiples of 10. 			10	700-HN158

Specifications

Table 155 - Control/Input Ratings

Cat. No.	Rated Control Voltage	Max. Operating Control Voltage Range	Max. Reverse Control Voltage	Impedance	Control Voltage Levels	
					Pick-up Voltage	Drop-out Voltage
700-SAZY5Z25	5...24V DC	4...32V DC	-32V DC	15 mA max. ⁽¹⁾	4V DC max.	1V DC min.
700-SANY3Z25		4...30V DC	-30V DC	1.5 kΩ (+20% -10%)		

(1) With constant current input circuit system, SSR impedance varies with a change in input voltage.

Table 156 - Load/Output Ratings

Cat. No.	Rated Load Voltage	Maximum Load Voltage Range	Continuous Load Current (Resistive) [A]		Max. Inrush Current ⁽¹⁾
			Min.	Max. ⁽²⁾	
700-SAZY5Z25	100...240V AC	75...264V AC	0.1	5.0	80 A, @ 50/60 Hz for 1 cycle
700-SANY3Z25	5...110V DC	3...125V DC	0.1	3.0	12 A (10 ms)

(1) If the SSR operation is continuous ON/OFF, this value should be reduced by 50%. See [Figure 156](#) for more details.

(2) Input impedance reaches its maximum at the operating voltage.

Table 157 - Characteristics

Description	Cat. No. 700-SAZY5Z25	Cat. No. 700-SANY3Z25
Load Switching Method/Device	Triac	Transistor
Pick-up Time	1/2 cycle of load power source cycle time ⁽¹⁾ + 1 ms max.	0.5 ms max.
Drop-out Time	1/2 cycle of load power source cycle time ⁽¹⁾ + 1 ms max.	2.5 ms max.
Output ON Voltage Drop	1.6V (RMS) max.	1.5V max.
Output Leakage Current	5 mA max. (at 100V AC); 10 mA max. (at 200V AC)	5 mA max. (at 125V DC)
Output V_{DRM} V_{CEO} (V)	600	150
Output di/dt (V/uS)	50	—
Output dv/dt (V/uS)	500	—
Output I^2t (A ² S)	41.6	—
Output Tj (°C) Max.	125	150
Insulation Resistance	100 MΩ min. (at 500V DC)	
Dielectric Strength	1500V AC, 50/60 Hz for 1 min	
Vibration Resistance (Max.)	10...55 Hz, 1.5 mm double amplitude (10 G)	
Shock Resistance (max.)	1000 m/s ² (100 G)	
Ambient Temperature	Operating	-30...+80 °C (-22...+176 °F) with no icing or condensation
	Storage	-30...+100 °C (-22...+212 °F) with no icing or condensation
Ambient Humidity	45...85% (no condensation)	
Standards Compliance	UL 508, CSA C22.2 No. 14, EN 60947-1, -4-3	
Certifications	cURus Recognized (File No. E96956, Guide NMFT2/NMFT8), CE Marked, VDE Certified	
Weight	Approx. 70 g	

(1) 60 Hz full cycle time = 16.6 ms, 50 Hz full cycle time 20 ms.

Figure 155 - Cat. No. 700-SA Load Current vs. Ambient Temperature Characteristics

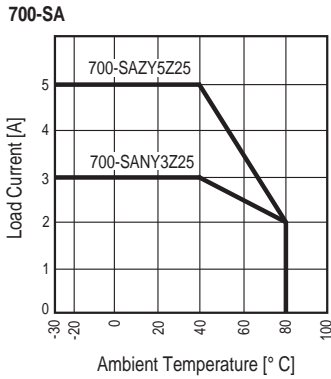
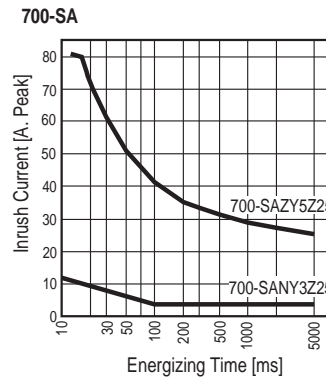


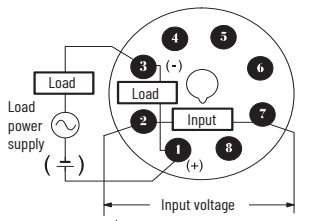
Figure 156 - Cat. No. 700-SA Inrush Current Resistivity



Inrush current resistivity is defined as the ability of an SSR to withstand a large surge current for a short period. Surges are considered non-repetitive (max. repeatability once every 2...5 seconds).

Keep the inrush current to half the rated value if it occurs repetitively. Exceeding the non-repetitive inrush current will damage the SSR.

Figure 157 - Terminal Arrangement (Bottom View)



Note: The plus and minus symbols shown in parentheses are for DC loads.

Basic Application Considerations

High Density Mounting of Multiple Solid-state Relays (SSRs)

If multiple SSRs are installed side by side, the outer case wall of the SSR serves to dissipate heat. Install the relays so that they are adequately ventilated. If poor ventilation is unavoidable, reduce the load current to half.

Protective Component

When controlling AC inductive loads, connect an inrush/surge absorbing device (varistor) across the SSR load terminals. If the SSR has built-in surge suppression (700-SE and 700-SH) and additional surge suppression is required, connect the varistor across the terminals of the load device. Select a varistor that meets the conditions of the load voltage that is outlined in [Table 158](#).

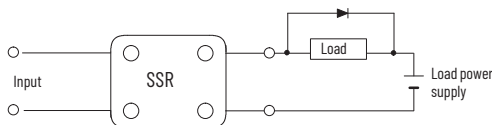
Table 158 - Relay Load and Varistor Voltage

Load Voltage	Varistor Voltage [V]	Varistor Surge Resistance
100...120V AC	240...270	1000 A min.
200...240V AC	440...470	
380...480V AC	820...1000	



For additional details on solid-state relays, see the Solid-State Relay Application Guide, publication [700-AT001](#).

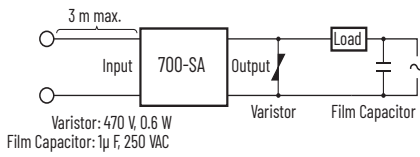
Figure 158 - DC Inductive Load Wiring



For a DC inductive load, a diode should be connected parallel to the load to absorb the counter electromotive force (OFF) of the load.

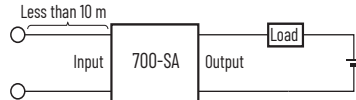
Figure 159 - EMC Directive Compliance

1. AC-switching models comply with EMC Directives under the following conditions:



- Connect a varistor between the output terminals.
- Connect a film capacitor to the load power supply.
- The input cable must be less than 3 m.

2. DC-switching models comply with EMC Directives under the following conditions:

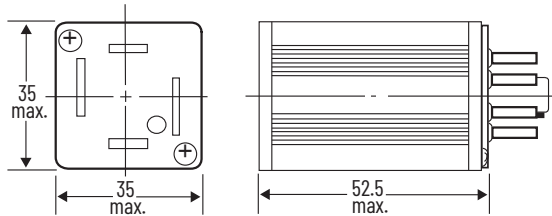


- The input cable must be less than 10 m.

Approximate Dimensions

All units in millimeters unless otherwise indicated. To convert millimeters to inches multiply by 0.0394. Dimensions are not intended to be used for manufacturing purposes.

Figure 160 - Cat. No. 700-SA Relays



700-SC Ice Cube Relays

- 3 A (resistive) max. continuous load (output) current
- 264V AC, 48V DC or 125V DC max. load voltage options
- 5...24V DC or 110/220V AC control (input) voltage options
- LED indicator (optional) for input/logic On/Off status monitoring
- 700-HN103, 700-HN104, or 700-HN128 socket compatible
- Compatible with 700-AT1 or 700-AT2 timer modules








Product Selection

Input-to-Output Isolation Method	Zero Cross Function	Status Indicator	Output (Load) Max. Continuous Current and Rated Voltage Range	Rated Input (Control) Voltage	Cat. No.
Photocoupler	Yes	Yes	3 A @ 100...240V AC ⁽¹⁾	5...24V DC	700-SCZY3Z25
			2 A @ 100...240V AC ⁽¹⁾	100/110V AC	700-SCZY2A1
Phototriac	No	3 A @ 100...240V AC ⁽¹⁾		200/220V AC	700-SCZY2A2
			24V DC	700-SCTY3Z24	
Photocoupler	Not Applicable	No	3 A @ 4...48V DC	5...24V DC	700-SCNY3Z25
				4...24V DC	700-SCZN3Z26
Phototriac	No	No	3 A @ 100...240V AC ⁽¹⁾	24V DC	700-SCTN3Z24
				4...24V DC	700-SCNN3Z26
Photocoupler	Not Applicable	No	3 A @ 4...48V DC	4...24V DC	700-SCNN3Z26
				5...24V DC	700-SCNN2Z25

(1) 47...63 Hz.


Accessories

Sockets and DIN Rail

	Description	For Use With	Pkg. Qty.	Cat. No.	
	<ul style="list-style-type: none"> • Guarded Terminal Construction 	700-HC Relays	10	700-HN103	
	Screw Terminal Socket <ul style="list-style-type: none"> • Panel or DIN Rail Mounting • $I_{th} = 10$ A per pole • 14-blade miniature socket 	<ul style="list-style-type: none"> • Guarded Terminal Construction • Coil and contact separation • Can be used with optional plug-in modules (700-A__ accessories, LED, surge suppression, timing modules) 	700-HC Relays	10	700-HN104
	<ul style="list-style-type: none"> • Open-Style Construction 	700-HC Relay	10	700-HN128	
	DIN (#3) symmetrical hat rail <ul style="list-style-type: none"> • 35 x 7.5 x 1 m 		10	199-DR1	
	Retainer Clip <ul style="list-style-type: none"> • Secures relay in socket⁽¹⁾ • Order must be for 10 clips or multiples of 10. 	Cat. Nos. 700-HN103, -HN104 and -HN128 Sockets with 700-SC Relays	10	700-HN114	

(1) See 700-HC Miniature Square Base Relay, Socket, and Retainer Clip Reference Chart.

Marking Systems

Photo	Description	Pkg. Qty.	Cat. No.
	Pre-printed Identification Tags <ul style="list-style-type: none"> • Contains 10 sheets of pre-printed and blank tags • Each sheet contains 13 sets of the markings CR...9CR, TR...9TR, M...9M, F, R, 1S, and 117 blank tags • Tags are peel-off with sticky backing for easy placement on relays 	10	700-N40
	Blank Identification Tags <ul style="list-style-type: none"> • contains 10 sheets of blank identification tags for customer specialized printing • Each sheet contains 546 blank tags • Tags are peel-off with sticky backing for easy placement on relays. 	10	700-N41

Specifications

Table 159 - Control/Input Ratings

Cat. No.	Rated Control Voltage	Max. Operating Control Voltage Range	Max. Reverse Control Voltage [V]	Impedance	Control Voltage Levels	
					Pick-up Voltage	Drop-out Voltage
700-SCZY3Z25	5...24V DC	4...28V DC	-28.8	15 mA max. ⁽¹⁾	4V DC max.	1V DC min.
700-SCZY2A1	100/110V AC	75...125V AC	NA	41 kΩ ±20%	75V AC max.	20V AC min.
700-SCZY2A2	200/220V AC	150...250V AC	NA	72 kΩ ±20%	150V AC max.	40V AC min.
700-SCTY3Z24	24V DC	19.2...28.8V DC	-28.8	2 kΩ ±20%	19.2V DC max.	1V DC min.
700-SCNY3Z25	5...24V DC	4...28V DC	-28	1.5 kΩ +20%/ -10% ⁽²⁾	4V DC max.	
700-SCZN3Z26	4...24V DC	3...28V DC	-28.8	15 mA max. ⁽¹⁾	3V DC max.	
700-SCTN3Z24	24V DC	19.2...28.8V DC	-28.8	2 kΩ ±20%	19.2V DC max.	
700-SCNN3Z26	4...24V DC	3...28V DC	-28	1.5 kΩ +20%/ -10% ⁽²⁾	3V DC max.	
700-SCNN2Z25	5...24V DC		-28.8			

(1) With constant current input circuit system. SSR impedance varies with a change in input (control) voltage.
 (2) Input impedance attains its maximum at the operating voltage.

Table 160 - Load/Output Ratings

Cat. No.	Rated Control Voltage	Max. Load Voltage Range	Continuous Load Current (Resistive) [A]		Max. Inrush Current ⁽¹⁾
			Min.	Max. ⁽²⁾	
700-SCZY3Z25	100...240V AC	75...264V AC	0.1	3	45 A (@50/60 Hz, 1 cycle)
700-SCTY3Z24					
700-SCZN3Z26					
700-SCTN3Z24					
700-SCZY2A1					
700-SCZY2A2					
700-SCNN3Z26	4...48V DC	3...52.8V DC	0.1	3	18 A (10 ms)
700-SCNY3Z25	5...110V DC	3...125V DC	0.1	2	10 A (10 ms)
700-SCNN2Z25					

(1) See [Figure 161](#) for additional load current details.
 (2) If the SSR operation is continuous ON/OFF, this value should be reduced by 50%. See [Figure 162](#) for details.

Table 161 - Characteristics

Description	Cat. No. 700-SCZ...	Cat. No. 700-SCT	Cat. Nos. 700-SCNY, 700- SCNN3...	Cat. Nos. 700-SCNN2...
Load Switching Method/Device	Triac		Transistor	
Pick-up time	1/2 of load power source cycle time ⁽¹⁾ + 1 ms max. (DC input)	1/2 of load power source cycle time ⁽¹⁾ + 1 ms max.	2 ms max.	2.5 ms max.
	3/2 of load power source cycle time ⁽¹⁾ + 1 ms max. (AC input)			
Drop-out time	1/2 of load power source cycle time ⁽¹⁾ + 1 ms max. (DC input)	1/2 of load power source cycle time ⁽¹⁾ + 1 ms max.	2 ms max.	2.5 ms max.
	3/2 of load power source cycle time ⁽¹⁾ + 1 ms max. (AC input)			
Output On Voltage Drop	1.6V (RMS) max.	1.6V (RMS)	1.5V max.	1.5V max.
Output Leakage Current	5 mA max (@ 100V AC) 10 mA max (@ 200V AC)	2.5 mA max (@ 100V AC) 5 mA max (at 200V AC)	5 mA max (@ 50V DC)	0.1 mA max (@ 100V DC)
Output V _{DRM} , V _{CEO} (V)	600	600	80	80
Output di/dt (A/uS)	50	50	—	—
Output dv/dt (V/uS)	250	250	—	—
Output I ² t (A ² S)	18	18	—	—
Output Tj (°C) Max.	125	125	150	150
Insulation Resistance	100 MΩ min (@500V DC)			
Dielectric Strength	1500V AC, 50/60 Hz for 1 minute			
Vibration Resistance (max.)	10...55 Hz, 1.5 mm double amplitude (10 G)			
Shock Resistance (max.)	1000 m/s ² (100 G)			
Ambient Temperature	Operating: -30...+80 °C (-22...+176 °F) with no icing or condensation Storage: -30...+100 °C (-22...+212 °F) with no icing or condensation			
Standards Compliance	UL 508, CSA C22.2 No. 14, EN/IEC 60950, EN 50011, EN 61000-6-2, EN/IEC 60947-1, -4-3			
Certifications	cURus Recognized (File No. E96956, Guide NMFT2/NMFT8), CE Marked, VDE Certified			
Ambient Humidity	Operating: 45...85% (no condensation)			
Weight	Approx. 50 g			

(1) 60 Hz full cycle time = 16.6 ms, 50 Hz full cycle time = 20 ms

Figure 161 - Load Current Versus Ambient Temperature Characteristics

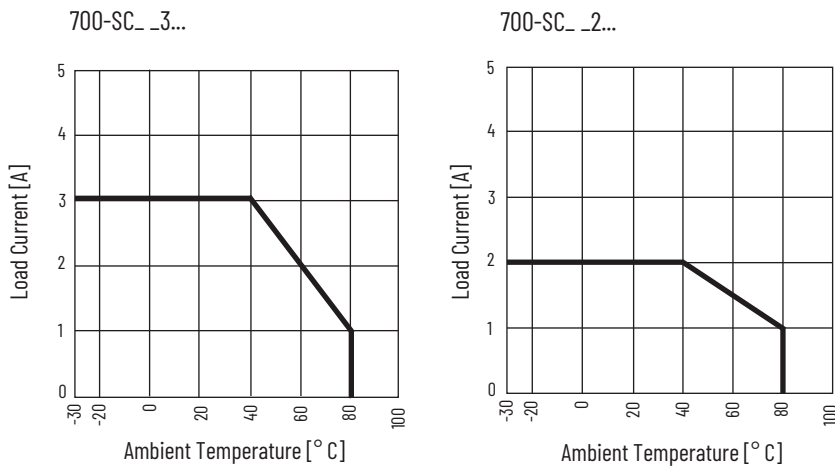
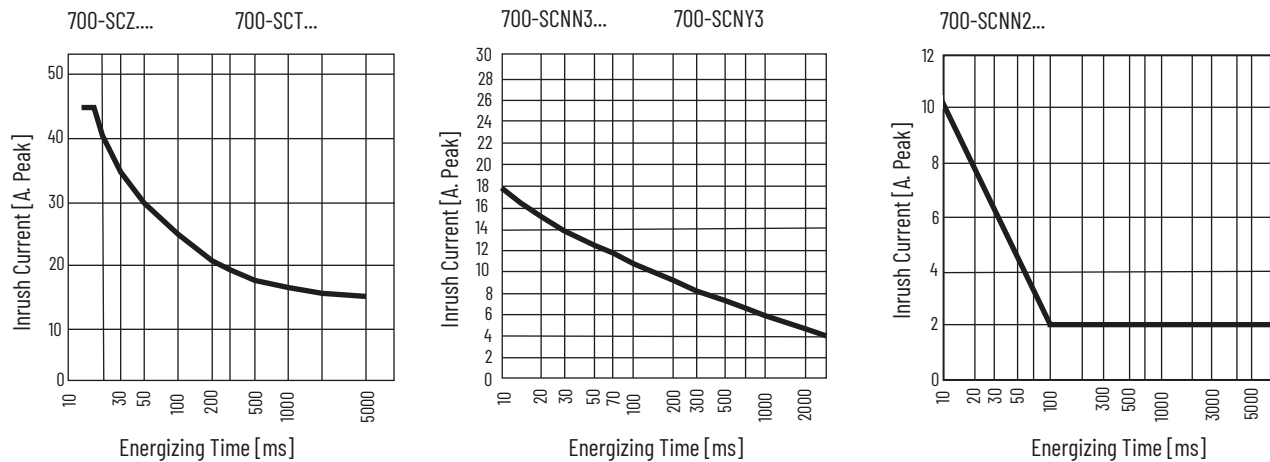


Figure 162 - Cat. No. 700-SC Inrush Current Resistivity

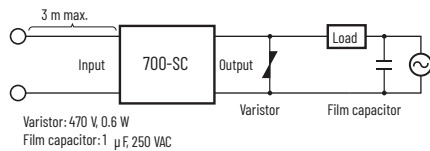


Inrush current resistivity is defined as the ability of an SSR to withstand a large surge current for a short period. Surges are considered non-repetitive (max. repeatability once every 2...5 seconds).

Keep the inrush current to half the rated value if it occurs repetitively. Exceeding the non-repetitive inrush current will damage the SSR.

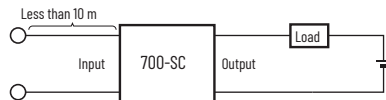
Figure 163 - EMC Directive Compliance

- AC-switching models comply with EMC Directives under the following conditions



- Connect a varistor between the output terminals.
- Connect a film capacitor to the load power supply.
- The input cable must be less than 3 m.

- DC-switching models comply with EMC Directives under the following conditions



- The input cable must be less than 10 m.

Basic Application Considerations for 700-SC Relays

High-density Mounting of Multiple Solid-state Relays (SSRs)

If multiple relays are mounted side by side, the outer wall of each SSR works as a radiator. The SSR casing serves to dissipate heat. Install the relays so that they are adequately ventilated. If poor ventilation is unavoidable, reduce the load current by half.

Connection

For DC Load Switching, 700-SC will operate properly if the load is connected to either the positive or negative SSR load terminal.

Protective Component

When controlling AC inductive loads, connect an inrush/surge absorbing device (varistor) across the SSR load terminals. If the SSR has built-in surge suppression (s 700-SE and 700-SH) and additional surge suppression is required, connect the varistor across the terminals of the load device. Select a varistor that meets the conditions of the load voltage that is outlined in [Table 162](#).

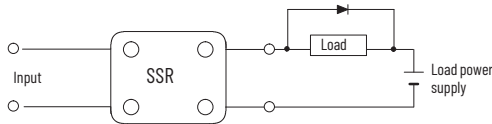
Table 162 - 700-SC Relay Load and Varistor Voltage

Load Voltage	Varistor Voltage [V]	Varistor Surge Resistance
100...120V AC	240...270	1000 A min.
200...240V AC	440...470	
380...480V AC	820...1000	



For additional details on solid-state relays, see the Solid-State Relay Application Guide, publication [700-AT001](#).

Figure 164 - DC Inductive Load Wiring

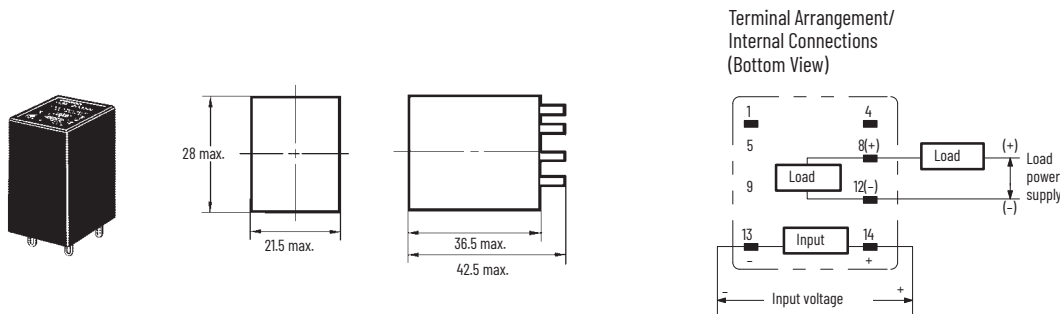


For a DC inductive load, a diode should be connected parallel to the load to absorb the counter electromotive force (OFF) of the load.

Approximate Dimensions

All units in millimeters unless otherwise indicated. To convert millimeters to inches multiply by 0.0394. Dimensions are not intended to be used for manufacturing purposes.

Figure 165 - Cat. No. 700-SC Relay Dimensions and Terminal Arrangement



Note : The plus and minus symbols shown in parentheses are for DC loads.

700-SF Square Base Relays






- 3 A (resistive) max. continuous load (output) current
- 264V AC or 52.8V DC max. load voltage options
- 4...24V DC control/input voltage
- Photocoupler or phototriac isolation option between control and output voltage
- LED Indicator for input/logic ON/OFF status monitoring
- Cat. No. 700-HN116 socket compatible

Product Selection


Input-to-Output Isolation Method	Zero Cross Function	Status Indicator	Output (Load) Max. Continuous Current and Rated Voltage Range	Rated Input Control Voltage	Cat. No.
Photocoupler	Yes	Yes	3 A @ 100...240V AC (47...63 Hz)	5...24V DC	700-SFZY3Z25
Phototriac	No			24V DC	700-SFTY3Z24
Photocoupler	Not Applicable		3 A @ 4...48V DC	4...24V DC	700-SFNY3Z25

Accessories

Sockets and DIN Rail

	Description	For Use With	Pkg. Qty.	Cat. No.
	Screw Terminal Socket <ul style="list-style-type: none"> • Panel or DIN Rail Mounting • 8-blade miniature socket 	700-HF DPDT relays	10	700-HN116
	DIN (#3) symmetrical hat rail <ul style="list-style-type: none"> • 35 x 7.5 x 1 m 		10	199-DR1
	Retainer Clip <ul style="list-style-type: none"> • Secures relay in socket • Order must be for 10 clips or multiples of 10. 	Cat. Nos. 700-HN116, 700-HN262 Sockets with 700-HF DPDT Relays	10	700-HN114

Marking Systems

Photo	Description	Pkg. Qty.	Cat. No.
	Pre-printed Identification Tags <ul style="list-style-type: none"> • Contains 10 sheets of pre-printed and blank tags • Each sheet contains 13 sets of the markings CR...9CR, TR...9TR, M...9M, F, R, 1S, and 117 blank tags • Tags are peel-off with sticky backing for easy placement on relays 	10	700-N40
	Blank Identification Tags <ul style="list-style-type: none"> • contains 10 sheets of blank identification tags for customer specialized printing • Each sheet contains 546 blank tags • Tags are peel-off with sticky backing for easy placement on relays. 	10	700-N41

Specifications

Table 163 - Control/Input Ratings

Cat. No.	Rated Control Voltage	Max. Operating Control Voltage Range [V DC]	Max. Reverse Control Voltage [V]	Impedance	Control Voltage Levels	
					Pick-up Voltage	Drop-out Voltage
700-SFZY3Z25	5...24V DC	4...28V DC	-32	15 mA max. ⁽¹⁾	4V DC max.	1V DC min.
700-SFTY3Z24	24V DC	19.2...28.8V DC	-28.8	2 k Ω \pm 20%	19.2V DC max.	1V DC min.
700-SFNY3Z25	5...24V DC	4...28V DC	-28.8	1.5 k Ω + 20%/-10% ⁽²⁾	4V DC max.	1V DC min.

(1) With constant current input circuit system, SSR impedance varies with a change in input voltage.

(2) Input impedance reaches its maximum at the operating voltage.

Table 164 - Load/Output Ratings

Cat. No.	Rated Control Voltage	Max. Load Voltage Range	Continuous Load Current (Resistive) [A]		Max. Inrush Current ⁽¹⁾
			Min.	Max. ⁽²⁾	
700-SFZY3Z25	100...240V AC	75...264V AC	0.1	3	45 A @ 50/60 Hz, 1 cycle
700-SFTY3Z24			0.1	3	
700-SFNY3Z25	4...48V DC	3...52.8V DC	0.1	3	18 A (10 ms)

(1) See [Figure 166](#) for additional load current details.

(2) If the SSR operation is continuous ON/OFF, this value should be reduced by 50%. See [Figure 167](#) and [Figure 168](#) for more details.

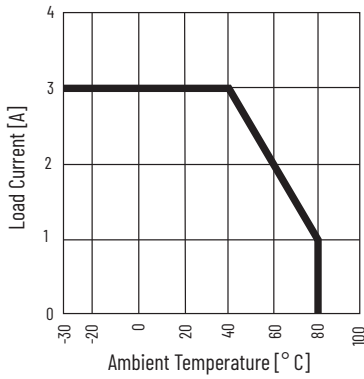
Table 165 - Characteristics

Description	Cat. No. 700-SFZY3Z25	Cat. No. 700-SFTY3Z24	Cat. No. 700-SFNY3Z25
Load Switching Method/Device	Triac	Transistor	
Pick-up Time	1/2 cycle of load power source cycle time ⁽¹⁾ (5) + 1 ms max.	1 ms max.	0.5 ms max.
Drop-out Time	1/2 cycle of load power source cycle time ⁽¹⁾ + 1 ms max.		2 ms max.
Output ON Voltage Drop	1.6V (RMS) max.		1.5V max.
Output Leakage Current	5 mA max. (@ 100V AC); 10 mA max. (@ 200V AC)	2.5 mA max. (@ 100V AC); 5 mA max. (@ 200V AC)	5 mA max. (@ 50V DC)
Output V_{DRM} , V_{CEO} (V)	600	600	80
Output di/dt (A/uS)	50	50	—
Output dv/dt (V/uS)	250	250	—
Output I^2t (A ² S)	18	18	—
Output Tj (°C) Max.	125	125	150
Insulation Resistance	100 M Ω min. (at 500V DC)		
Dielectric Strength	1,500V AC, 50/60 Hz for 1 min		
Vibration Resistance (Max.)	10...55 Hz, 1.5 mm double amplitude (10 G)		
Shock Resistance (Max.)	1000 m/s ² (100 G)		
Ambient Temperature	Operating: -30...+80 °C (-22...+176 °F) with no icing or condensation Storage: -30...+100 °C (-22...+212 °F) with no icing or condensation		
Ambient Humidity	45...85% (no condensation)		
Standards Compliance	UL 508, CSA C22.2 No. 14, EN/IEC 60947-1, -4-3, EN/IEC 60950		
Certifications	cURus Recognized (File No. E96956, Guide NMFT2/NMFT8), CE Marked, VDE Certified		
Weight	Approx. 50 g		

(1) 60 Hz full cycle time = 16.6 ms, 50 Hz full cycle time 20 ms.

IMPORTANT This data is non-repetitive. Keep the inrush current to half the rated value if it occurs repetitively. Inrush current resistivity is the ability of an SSR to withstand a large surge current for a short period.

Figure 166 - Cat. No. 700-SF Load Current vs. Ambient Temperature Characteristics



Inrush current resistivity is defined as the ability of an SSR to withstand a large surge current for a short period. Surges are considered non-repetitive (max. repeatability once every 2...5 seconds).

Keep the inrush current to half the rated value if it occurs repetitively. Exceeding the non-repetitive inrush current will damage the SSR.

Figure 167 - Cat. No. 700-SFZ, -SFT Inrush Current Resistivity

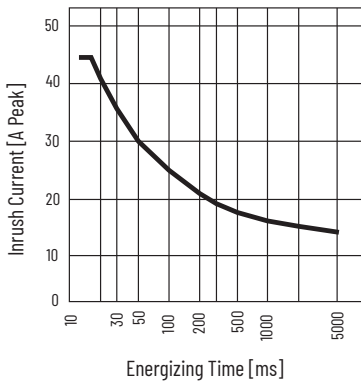


Figure 168 - Cat. No. 700-SFN Inrush Current Resistivity

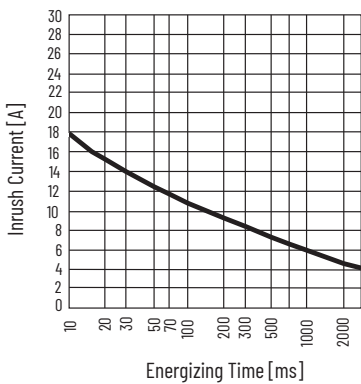
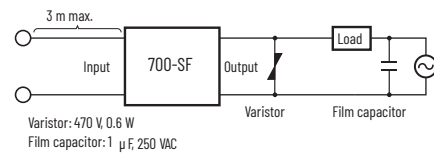


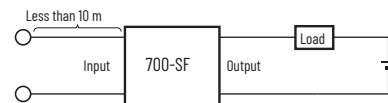
Figure 169 - EMC Directive Compliance

1. AC-switching models comply with EMC Directives under the following conditions



- Connect a varistor between the output terminals.
- Connect a film capacitor to the load power supply.
- The input cable must be less than 3 m.

2. DC-switching models comply with EMC Directives under the following conditions



- The input cable must be less than 10 m.

Basic Application Considerations of 700-SF

High-density Mounting of Multiple Solid-state Relays (SSRs)

If multiple SSRs are mounted side by side, the outer case wall of the SSR acts as a radiator. The SSR case serves to dissipate heat. Install the relays so that they are adequately ventilated. If poor ventilation is unavoidable, reduce the load current by half.

Connection

For DC load switching, the Bul. 700-SF SSR will operate properly if the load is connected to either the positive or negative load terminals.

Protective Component to Extend SSR Life

When controlling AC inductive loads, connect an inrush/surge absorbing device (varistor) across the SSR load terminals. If the SSR

has built-in surge suppression (700-SE and 700-SH) and additional surge suppression is required, connect the varistor across the terminals of the load device. Select a varistor that meets the conditions of the load voltage that is outlined in [Table 162](#).

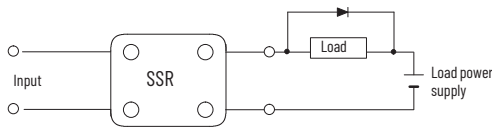
Table 166 - 700-SF Relay Load and Varistor Voltage

Load Voltage	Varistor Voltage [V]	Varistor Surge Resistance
100...120V AC	240...270	1000 A min.
200...240V AC	440...470	
380...480V AC	820...1000	



For additional details on solid-state relays, see the Solid-State Relay Application Guide, publication [700-AT001](#).

Figure 170 - DC Inductive Load Wiring

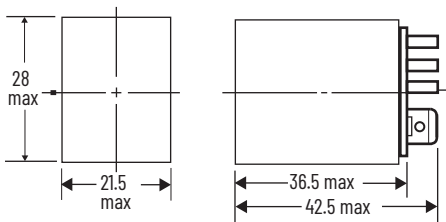


For a DC inductive load, a diode should be connected parallel to the load to absorb the counter electromotive force (OFF) of the load.

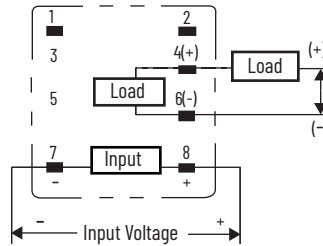
Approximate Dimensions

All units in millimeters unless otherwise indicated. To convert millimeters to inches multiply by 0.0394. Dimensions are not intended to be used for manufacturing purposes.

Cat. No. 700-SF Relay Dimensions and Terminal Arrangement



Terminal Arrangement/Input Connections (Bottom View)



- Notes: 1. The plus and minus symbols shown in parentheses are for DC loads.
- 2. The coil has no polarity.

700-SH Hockey Puck Relays

- 100 A max. continuous load (output) current with appropriate heat sink
- 264V AC, 530V AC, or 660V AC max. load voltage options
- 3...32V DC, 4...32V DC, 80...130V AC, 200...260V AC, 20...280V AC/22...48V DC control (input) voltage options
- LED indicator for input/logic ON/OFF status monitoring
- Protective cover for added safety



Product Selection

Input-to-Output Isolation Method	Zero Cross Function	Status Indicator	Output (Load) Max. Continuous Current and Rated Voltage Range ⁽¹⁾	Rated Input Control Voltage	Cat. No. ⁽²⁾
Optocoupler	Yes	Yes	10 A @ 42...265V AC	3...32V DC	700-SH10JZ24
			10 A @ 42...265V AC	80...130V AC	700-SH10JA12
			10 A @ 42...265V AC	200...260V AC	700-SH10JA22
			10 A @ 42...530V AC	4...32V DC	700-SH10HZ25 (Series B)
			25 A @ 42...530V AC	4...32V DC	700-SH25HZ25 (Series B)
			25 A @ 24...265V AC	3...32V DC	700-SH25GZ24
			25 A @ 24...265V AC	20...280V AC/22...48V DC	700-SH25GA24
			50 A @ 24...265V AC	3...32V DC	700-SH50GZ24
			50 A @ 24...265V AC	20...280V AC/22...48V DC	700-SH50GA24
			50 A @ 42...530V AC	4...32V DC	700-SH50HZ25
			25 A @ 42...660V AC	4...32V DC	700-SH25VZ25
			25 A @ 42...660V AC	20...280V AC/22...48V DC	700-SH25VA24
			50 A @ 42...660V AC	4...32V DC	700-SH50VZ25
			50 A @ 42...660V AC	20...280V AC/22...48V DC	700-SH50VA24
			75 A @ 42...530V AC	4...32V DC	700-SH75HZ25
			75 A @ 42...660V AC	4...32V DC	700-SH75VZ25
			75 A @ 42...530V AC	20...280V AC/22...48V DC	700-SH75HA24
			75 A @ 42...660V AC	20...280V AC/22...48V DC	700-SH75VA24
			100 A @ 42...530V AC	4...32V DC	700-SH100HZ25
			100 A @ 42...530V AC	20...280V AC/22...48V DC	700-SH100HA24
100 A @ 42...660V AC	4...32V DC	700-SH100VZ25			
100 A @ 42...660V AC	20...280V AC/22...48V DC	700-SH100VA24			
Yes	No	5 A @ 3...60V DC	3...32V DC	700-SH5FZ24	
Yes	Yes	25 A @ 90...280V AC	4...20 mA DC	700-SH25WA25	
		50 A @ 90...280V AC	4...20 mA DC	700-SH50WA25	

(1) When used with heat sink.

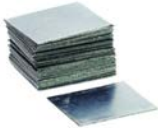


(2) All catalog numbers are Series A unless noted.

Accessories

Heat Sinks and Accessories

	Description	Pkg. Quantity	Cat. No.	
	Heat Sink • Panel or DIN Rail Mount	10 A	1	700-SN10
		25 A	1	700-SN25
		50 A	1	700-SN50
		75 A	1	700-SN50HC
		100 A	1	700-SN50VHC
	DIN (#3) symmetrical hat rail • 35 x 7.5 x 1 m	10		199-DR1

Heat Sinks and Accessories (Continued)

	Description		Pkg. Quantity	Cat. No.
	Thermal Conductive Pads • Thermal pad (35x42 mm) intended to be affixed to SSR for thermal transfer between SSR and heatsink (50 pieces/pack)		50	700-SHCPAD
	Plastic Covers	for DC output version	25	700-SHCOV
	Thermal Adapters	for 100 A Wire	10	700-SHTRMA

Specifications

Table 167 - Control/Input Ratings

Cat. No.	Operating Voltage	Input Current @ Max. Voltage	Voltage Level Pickup Voltage	Drop-out Voltage
700-SH10J...	3...32V DC	12 mA	2.75V DC max.	1.2V DC min.
	80...130V AC	13 mA	70V AC max.	30V AC min. ⁽¹⁾
	200...280V AC	13 mA	190V AC max.	90V AC min.
700-SH_ _ H...	4...32V DC	12 mA	4V DC max.	1V DC min.
	20...280V AC/22...48V DC	20 mA	18V AC/DC	6V AC/DC
700-SH_ _ G...	3...32V DC	12 mA	2.5V DC	1.2V DC
	20...280V AC/22...48V DC	20 mA	-32V DC	6V AC/DC
700-SH_ _ V...	4...32V DC	12 mA	3.5V DC	1.2V DC
	20...280V AC/22...48V DC	20 mA	18V AC/DC	6V AC/DC
700-SH_ _ W...	Current Control	4...20 mA	—	—
700-SH_ _ F...	3...32V DC	12 mA	3V DC max.	1.0V DC

(1) When specified heatsink is used.

Table 168 - Output Ratings

Cat. No.	Load Voltage Range	Applicable Load Current with Heat Sink [A] ⁽¹⁾
700-SH5FZ24	3...60V DC	0.001...5 A DC
700-SH10J...	42...265V AC	0.15...10
700-SH10H...	42...530V AC	0.15...10
700-SH25G...	24...265V AC	0.15...25
700-SH25H...	42...530V AC	0.15...25
700-SH25V...	42...660V AC	0.15...25
700-SH25W...	90...280V AC	0.15...25
700-SH50G...	24...265V AC	0.15...50
700-SH50H...	42...530V AC	0.15...50
700-SH50V...	42...660V AC	0.15...50
700-SH50W...	90...280V AC	0.15...50
700-SH75H...	42...530V AC	0.15...75
700-SH75V...	42...660V AC	0.15...75
700-SH100H...	42...530V AC	0.15...100
700-SH100V...	42...660V AC	0.15...100

(1) AC unless indicated.

Table 169 - Characteristics

Description	Cat. Nos. 700-SH10, 25, 50 (not including 700-SH_ _W)	Cat. Nos. 700-SH75, 100
Pick-up Time	1/2 of load power source cycle time (DC input) / 1 of load power source cycle time (AC input)	
Drop-out Time	1/2 of load power source cycle time (DC input) / 2 of load power source cycle time (AC input)	
Output ON Voltage Drop	1.6V (RMS) max.	
Output Leakage Current	<3 mA _{RMS} , 100 MΩ min (@ 500V DC)	
Insulation Resistance	100 MΩ min. (at 500V DC)	
Dielectric Strength	>4000V AC _{RMS}	
Vibration Resistance	Malfunction: 10...55 Hz, 1.5 mm double amplitude	
Shock Resistance	Malfunction: 1000 m/s ²	
Ambient Temperature	Operating: -20...+70 °C (-4...+158 °F) with no icing or condensation	
	Storage: -40...+100 °C (-40...+212 °F) with no icing or condensation	
Ambient Humidity	0...95% no condensing	
Standards Compliance	UL 508, CSA C22.2 No. 14, EN/IEC 60947-1, -4-2, -4-3, EN 61000-6-2, EN 61000-6-4	
Certifications	cURus Recognized (File No. E14843, Guide NPNT2), CSA Certified (File No. 240924)	
Weight	Approx. 60 g	Approx. 100 g

Table 170 - 700-SH_ _W Characteristics

Description	Cat. No. 700-SH_ _W
Pick-up Current	4.2 mA
Drop-out Current	4.1 mA
Voltage Drop	<10V DC @ 20 mA
Leakage Current	<3 mA
Insulation Voltage	<4000 V _{RMS}
Vibration Resistance	Malfunction: 10...55 Hz, 1.5 mm double amplitude
Shock Resistance	Malfunction: 1000 m/s ²
Ambient Temperature	Operating: -20...+70 °C (-4...+158 °F) with no icing or condensation
Ambient Humidity	0...95% no condensing
Standards Compliance	UL 508, CSA C22.2 No. 14, EN/IEC 60947-1, -4-2, -4-3, EN 61000-6-2, EN 61000-6-4
Certifications	cURus Recognized (File No. E14843, Guide NPNT2), CSA Certified (File No. 24024)
Weight	Approx. 60 g

Table 171 - Cat. No. 700-SH5FZ24 Characteristics

Description	Cat. No. 700-SH5FZ24
Pick-up Voltage	<3V DC
Drop-out Voltage	>1V DC
Activating Frequency	<100 Hz
Input Impedance	1 kΩ
Response Time Pick-up @ Vin > 5V	<4000 μS
Response Time Drop-out	<1 mS
On-state Voltage Drop @ Rated Current	<1.5V
Off-state Current Drop @ Rated Voltage	<1 mA
Insulation Voltage	<1 mA
Vibration Resistance	Malfunction: 10...55 Hz, 1.5 mm double amplitude
Shock Resistance	Malfunction: 1,000 m/s ²
Ambient Temperature	Operating: -20...+70 °C with no icing or condensation
Ambient Humidity	0...95% no condensing
Standards Compliance	UL 508, CSA C22.2 No. 14, EN/IEC 60947-1, -4-2, -4-3, EN 61000-6-2, EN61000-6-4
Certifications	cURus Recognized (File No. E14843, Guide NPNT2), CSA Certified (File No. 240924)
Weight	Approx. 60 g

Surge Current vs. Ambient Temperature Characteristics

Figure 171 - Surge Current Resistivity Curves, 10...25 A Devices

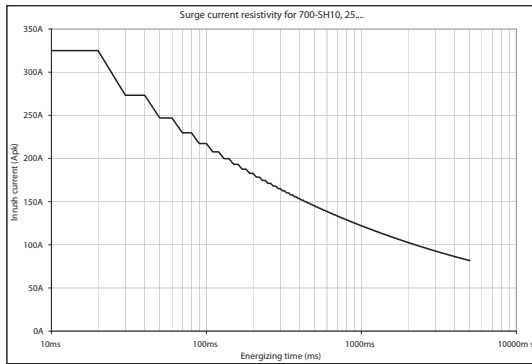


Figure 173 - Surge Current Resistivity Curves, 75 A Devices

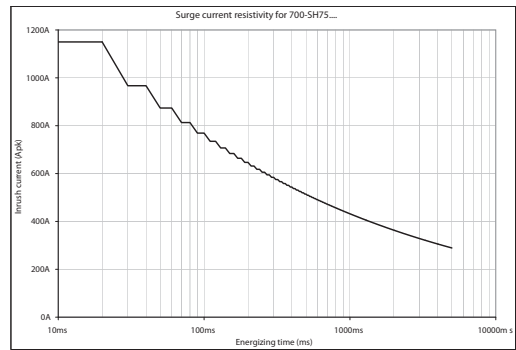


Figure 172 - Surge Current Resistivity Curves, 50 A Devices

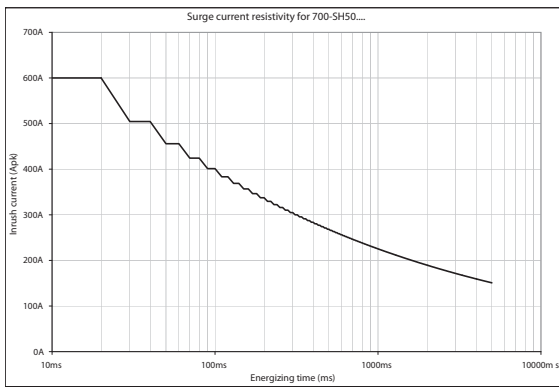
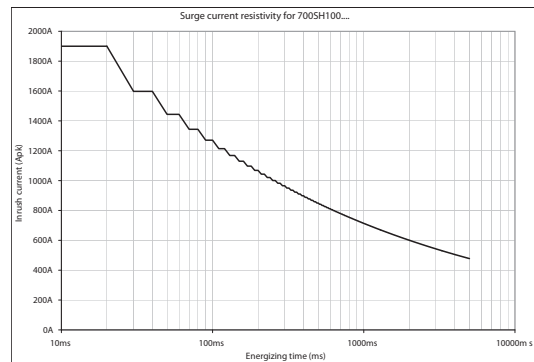


Figure 174 - Surge Current Resistivity Curves, 100 A Devices



Load Current vs. Ambient Temperature Characteristics

Figure 175 - Load Current vs. Ambient Temperature Curves, 10 A Devices

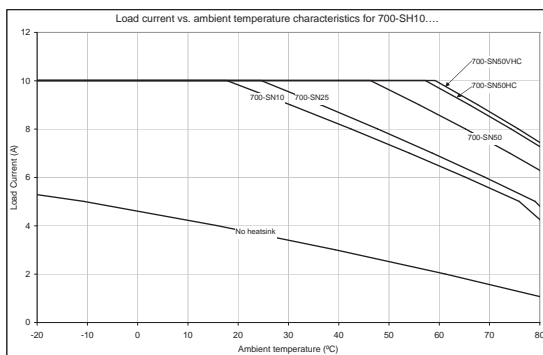


Figure 176 - Load Current vs. Ambient Temperature Curves, 25 A Devices

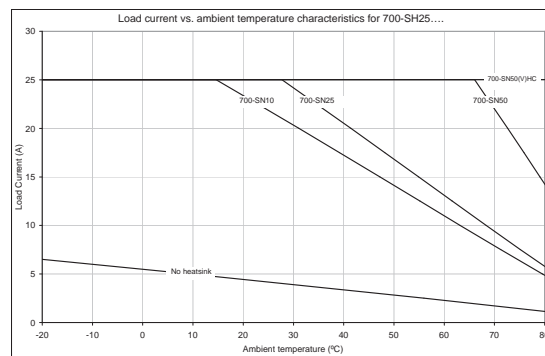


Figure 177 - Load Current vs. Ambient Temperature Curves, 50 A Devices

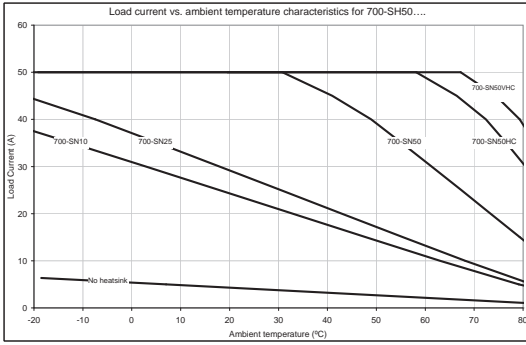


Figure 180 - Load Current vs. Ambient Temperature Curves, DC Devices

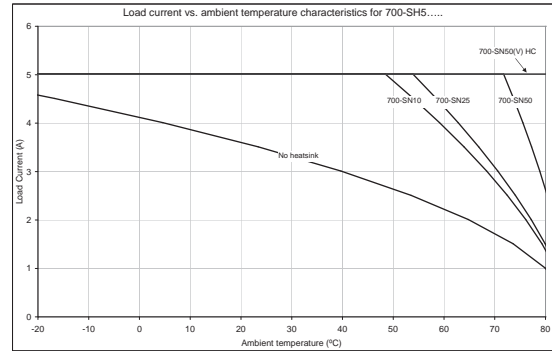


Figure 178 - Load Current vs. Ambient Temperature Curves, 75 A Devices

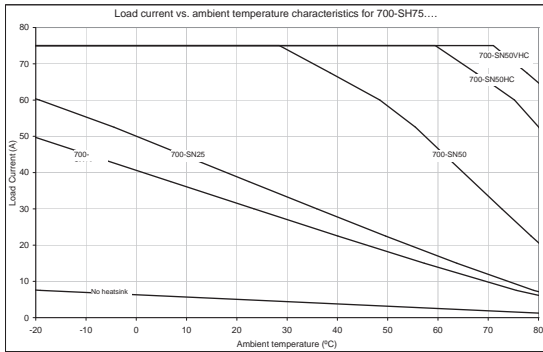
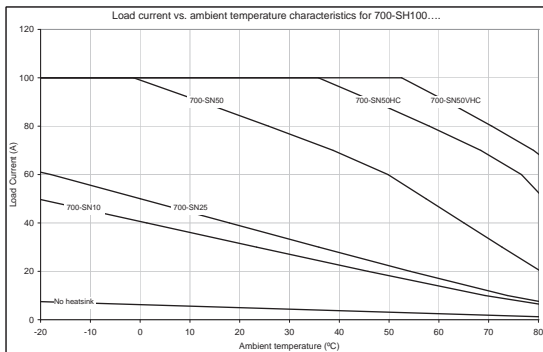


Figure 179 - Load Current vs. Ambient Temperature Curves, 100 A Devices



Load Connection

- For an AC load, use a power supply that is rated at 50 Hz. or 60 Hz. The maximum operating frequency is 10 Hz.
- The 700-SH has a built-in varistor for surge/inrush protection of AC loads. If additional suppression is required, connect an external varistor across the load device terminals. Select a varistor that meets the conditions of the load voltage that is outlined in [Table 172](#).

Table 172 - 700-SH Relay Load and Varistor Voltage

Load Voltage	Varistor Voltage [V]	Varistor Surge Resistance
100...120V AC	240...270	1000 A min.
200...240V AC	440...470	
380...480V AC	820...1000	

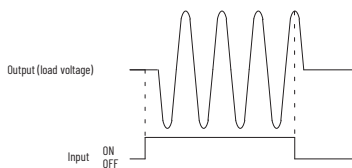


For additional details on solid-state relays, see the Solid-State Relay Application Guide, publication [700-AT001](#).

Zero Cross Function

An SSR with a zero cross function operates when an AC load voltage reaches the zero point or its vicinity. This reduces clicking noises when the load is switched and minimizes the influence of an inductive load, (such as, lamp, heater, or motor) on the power supply because the inrush current of the load is reduced. This can also minimize the scale of the inrush current protection circuit.

Figure 181 - Zero Cross Function



At a low applied voltage (for example, 24V AC) the load current is not fully supplied. When the unit is switched ON, the voltage required to power the unit deprives the output signal of the necessary voltage level and thus creates loss time. The lower the load voltage is, the greater the loss time is. This condition, however, will not create any serious problems.

Figure 182 - Zero Cross Loss Time

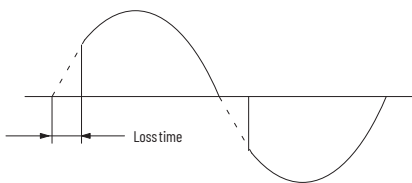
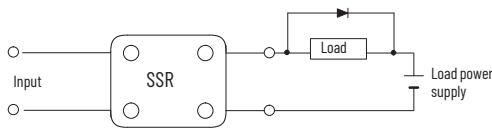


Figure 183 - DC Inductive Load Wiring

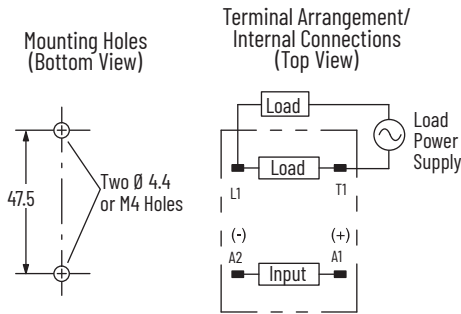


For a DC inductive load, a diode should be connected parallel to the load to absorb the counter electromotive force (OFF) of the load.

Approximate Dimensions

All units are in millimeters unless otherwise indicated. To convert to inches multiply by 0.0394. Dimensions are not intended for manufacturing purposes.

Figure 184 - Mounting Considerations



- The proper mounting orientation of the heat sink is so the heat fins run perpendicular to the floor (vertical) to maximize ventilation flow. If the fins do not run perpendicular to the floor, a 30% current derating is required.
- When attaching a heat sink to 700-SH, apply a thin layer of heat conductive grease (approximately 0.002 in. thick) on the heat sink to maximize heat transfer between the SSR and the heat sink.
 - Recommended types: Silicon based, Dow Corning 340, Toshiba YG6240; Non-silicon based, AOS company type 53300 (Cat. No. 46801-010-01).
- Tighten the SSR panel/heat sink mounting screws to a torque of 0.78...0.98 N•m (6.9...8.7 lb•in).
- Tighten the SSR terminal wiring screws as follows M4: 0.98...1.37 N•m (8.67...12.12 lb•in), M5: 1.57...2.35 N•m (13.89...20.8 lb•in).

Figure 185 - Cat. No. 700-SH5F...

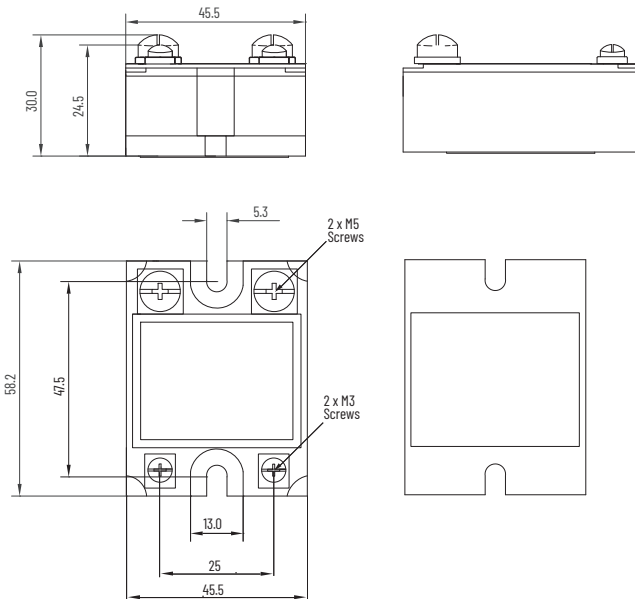


Figure 186 - Cat. No. 700-SH10, -SH25, -SH50, -SH75, -SH100

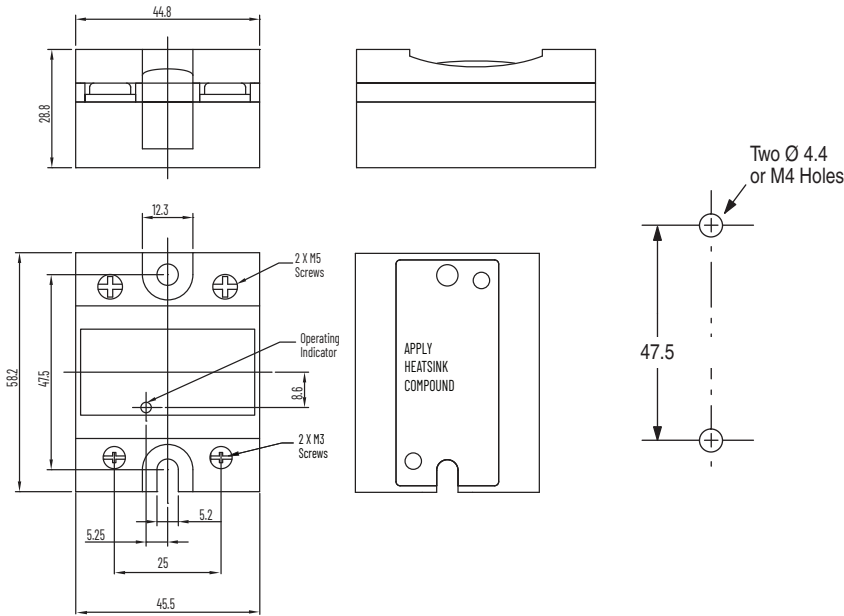


Figure 187 - Cat. Nos. 700-SN10, -SN25 Heat Sinks

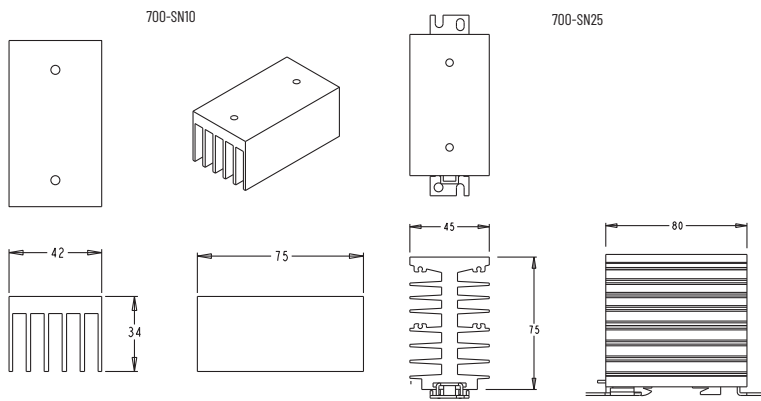


Figure 188 - Cat. No. 700-SN50, -SN50HC Heat Sinks

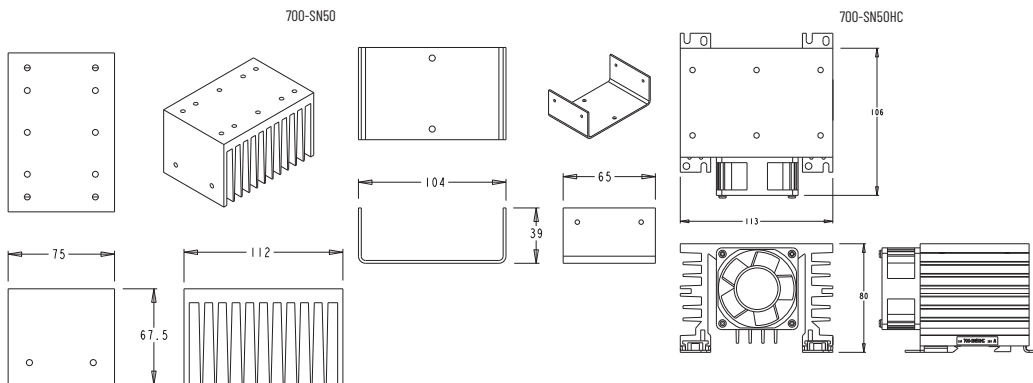


Figure 189 - Cat. No. 700-SN50VHC Heat Sink

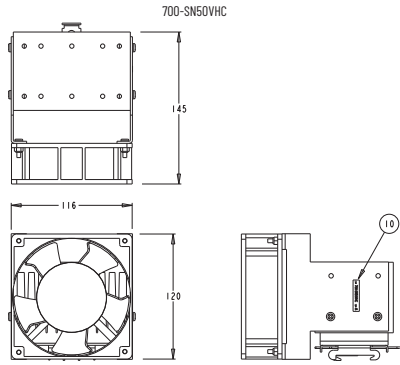


Figure 190 - Cat. No. 700-SHTRMA

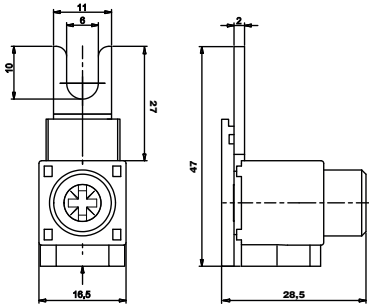
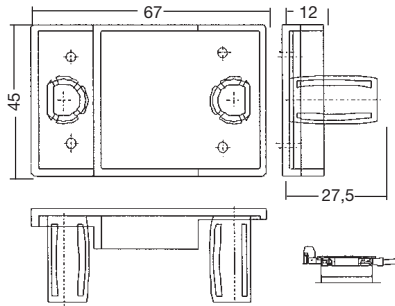


Figure 191 - Cat. No. 700-SHCOV



700-SK Slim Line Relays

- High-response speed models
- Input sensor module to allow high voltage 100...240V AC or 12...24V DC sensor
- Interface to low voltage (logic) device such as a PC output module for typical SSR applications
- LED indicator
- Input modules and output modules can be used with the 700-HN121 or 700-HN221 sockets



Product Selection

Input/Sensor Module

Input-to-Output Isolation Method	Status Indicator	Response Frequency	Logic Level		Rated Input Sensor Voltage	Cat. No.
			Supply Voltage	Supply Current		
Photocoupler	Yes	10 Hz	4...32V DC	0.1...100 mA	100...240V AC ⁽¹⁾	700-SKICA18
		1 kHz			12...24V DC	700-SKICZ24

(1) 47...63 Hz




Output/SSR Module

Input-to-Output Isolation Method	Zero Cross Function	Status Indicator	Output (Load) Max. Continuous Current and Rated Voltage Range	Rated Input Control Voltage	Cat. No.
Phototriac	Yes	Yes	2 A @ 100...240V AC ⁽¹⁾	5...24V DC	700-SK0Z2Z25
	No				700-SK0N2Z25
Photocoupler	Not Applicable		2 A @ 5...48V DC		700-SK0C2Z25
			1.5 A @ 48...200V DC		700-SK0C1Z25


(1) 47...63 Hz

Accessories

Sockets and Adapters

	Description	For Use With	Pkg. Qty.	Cat. No.	
	Screw Terminal Socket <ul style="list-style-type: none"> • Panel or DIN Rail Mounting • 5-blade miniature socket 	<ul style="list-style-type: none"> • 10 A rating • Accepts forked lug conductors • Includes retainer clip 	1-pole 700-SK relays	10	700-HN121
	DIN (#3) symmetrical hat rail <ul style="list-style-type: none"> • 35 x 7.5 x 1 mm 			10	199-DR1
	8-Way Jumper <ul style="list-style-type: none"> • Can be cut to required length • 10 A rating @ 250V 	Red	700-SK relays	1	700-HN180R
		Grey			700-HN180G
		Blue			700-HN180B

Marking Systems

Photo	Description	Pkg. Qty.	Cat. No.
	Pre-printed Identification Tags <ul style="list-style-type: none"> • Contains 10 sheets of pre-printed and blank tags • Each sheet contains 13 sets of the markings CR...9CR, TR...9TR, M...9M, F, R, 1S, and 117 blank tags • Tags are peel-off with sticky backing for easy placement on relays 	10	700-N40
	Blank Identification Tags <ul style="list-style-type: none"> • contains 10 sheets of blank identification tags for customer specialized printing • Each sheet contains 546 blank tags • Tags are peel-off with sticky backing for easy placement on relays. 	10	700-N41

Specifications

Input Sensor Module

Table 173 - Input Sensor Ratings

Cat. No.	Rated Input Voltage	Max. Operating Input Voltage Range	Input Current	Pick-up Voltage	Drop-out Voltage
700-SKICZ24	12...24V DC	6.6...32V DC	8 mA max.	6.6V DC max.	3.6V DC min.
700-SKICA18	100...240V AC	60...264V AC	15 mA max.	60V AC max.	20V AC min.

Table 174 - Output Logic Ratings

Cat. No.	Logic Level Supply Voltage	Logic Level Supply Current Draw
700-SKICZ24	4...32V DC	0.1...100 mA
700-SKICA18		

Table 175 - Characteristics

Description	Cat. No. 700-SKICA18	Cat. No. 700-SKICZ24
Pick-up time	20 ms max.	0.1 ms max.
Drop-out time	20 ms max.	0.1 ms max.
Response frequency	10 Hz	100 Hz
Output ON voltage drop	1.6V max.	
Leakage current (from SSR)	5 µA max.	
Output V_{DRM} , V_{CEO} (V)	80 (ref. value)	80 (ref. value)
Output di/dt (A/uS)	–	–
Output dv/dt (V/uS)	–	–
Output I^2t (A ² S)	–	–
Output Tj (°C) Max.	150	150
Insulation Resistance	100 MΩ min. between input and output	
Dielectric Strength	4000V AC, 50/60 Hz for 1 min between input and output	
Vibration Resistance (Max.)	10...55 Hz, 1.5 mm double amplitude (10 G)	
Shock Resistance (Max.)	1000 m/s ² (100 G)	
Ambient Temperature	Operating	-30...+80 °C (-22...+176 °F) with no icing or condensation
	Storage	-30...+100 °C (-22...+212 °F) with no icing or condensation
Standards Compliance	UL 508, CSA C22.2 No. 14, EN/IEC 60950	
Certifications	cURus Recognized (File No. E96956, Guide NMFT2/NMFT8), CE Marked, TÜV Certified	
Ambient Humidity	Operating	45...85% (no condensation)
Weight	Approx. 18 g	

Output SSR Module

Table 176 - Control/Input Ratings

Cat. No.	Rated Control Voltage	Max. Operating Control Voltage Range	Max. Reverse Control Voltage	Impedance (1)	Pick-up Voltage	Drop-out Voltage
700-SK0Z2Z25	5...24V DC	4...32V DC	-32V DC	15 mA max. at 25 °C (77 °F)	4V DC max.	1V DC min.
700-SK0N2Z25						
700-SK0C2Z25				8 mA max.		
700-SK0C1Z25						

Table 177 - Load/Output Ratings

Cat. No.	Rated Load Voltage	Maximum Load Voltage Range	Continuous Load Current (Resistive) [A]		Max. Inrush Current ⁽³⁾
			Min.	Max. ⁽²⁾	
700-SK0Z2Z25	100...240V AC	75...264V AC	0.05	2	30 A (@50/60 Hz, One cycle)
700-SK0N2Z25					
700-SK0C2Z25	5...48V DC	4...60V DC	0.1	2	8 A (10 ms)
700-SK0C1Z25	48...200V DC	40...200V DC	0.1	1.5	8 A (10 ms)

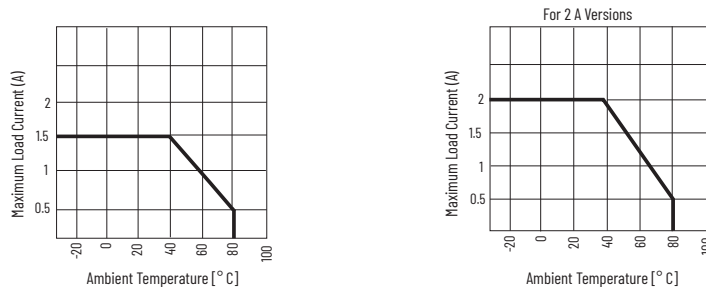
- (1) With a constant current input system. SSR impedance varies with a change in input voltage.
- (2) See [Figure 192](#) for additional details.
- (3) If the SSR operation is continuous ON/OFF, this value should be reduced by 50%. See the "Inrush Current Resistivity" graphs on page 126 for more details.

Table 178 - Characteristics

Description	Cat. No. 700-SK0Z2Z25	Cat. No. 700-SK0N2Z25	Cat. No. 700-SK0C2Z25	Cat. No. 700-SK0C1Z25
Load Switching Method/Device	Triac			Transistor
Pick-up Time	1/2 cycle of load power source cycle time ⁽¹⁾ + 1 ms max.			1 ms max.
Drop-out Time	1/2 of load power source cycle time ⁽¹⁾ + 1 ms max.			2 ms max.
Response Frequency	20 Hz			100 Hz
Output ON Voltage Drop	1.6V max.			2.5V max.
Leakage Current (from SSR)	1.5 mA max.			1 mA max.
Output V _{DRM} , V _{CEO} (V)	600 (ref.value)	600 (ref.value)	80 (ref.value)	400 (ref.value)
Output di/dt (A/uS)	30	30	—	—
Output dv/dt (V/uS)	300	300	—	—
Output I ² t (A ² S)	10.4	10.4	—	—
Output T _j (°C) Max.	125	125	150	150
Insulation Resistance	100 MΩ min. between input and output			
Dielectric Strength	4000V AC, 50/60 Hz for 1 min between input and output			
Vibration Resistance (Max.)	10...55 Hz, 1.5 mm double amplitude (10 G)			
Shock Resistance (Max.)	1000 m/s ² (100 G)			
Ambient Temperature	Operating	-30...+80 °C (-22...+176 °F) with no icing or condensation		
	Storage	-30...+100 °C (-22...+212 °F) with no icing or condensation		
Standards Compliance	UL 508, CSA C22.2 No. 14, EN/IEC 60950			
Certifications	cURus Recognized (File No. E96956, Guide NMFT2/NMFT8), CE Marked, TÜV Certified			
Ambient Humidity	Operating	45...85% (no condensation)		
Weight	Approx. 18 g			

(1) 60 Hz cycle time = 16.6 ms, 50 Hz cycle time = 20 ms.

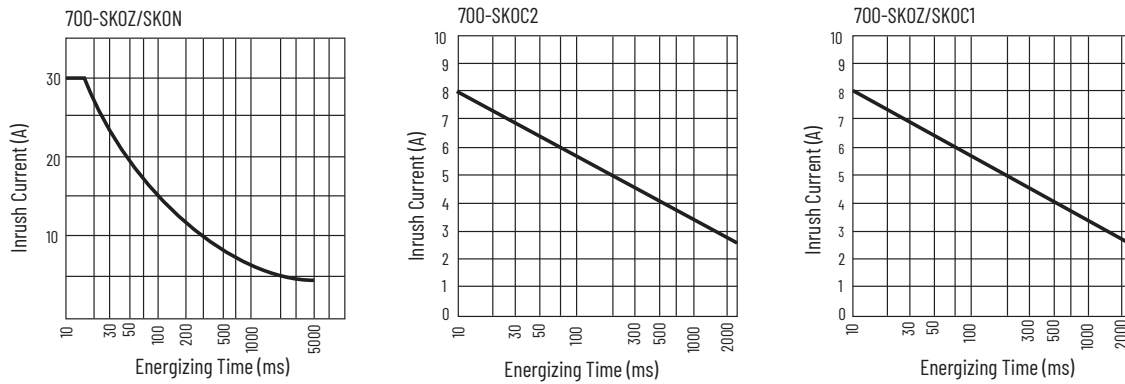
Figure 192 - Load Current vs. Ambient Temperature Characteristics



Inrush current resistivity is defined as the ability of an SSR to withstand a large surge current for a short period. Surges are considered non-repetitive (max. repeatability once every 2...5 seconds).

Keep the inrush current to half the rated value if it occurs repetitively. Exceeding the non-repetitive inrush current will damage the SSR.

Figure 193 - Inrush Current Resistivity



Application Considerations of the 700-SK Relay

Connection

For DC load switching, 700-SK SSR will operate properly if the load is connected to either the positive or negative SSR load terminal. The load can be connected to either positive or negative output terminals of the SSR.

Protective Element (to extend SSR life)

Because the SSR does not incorporate a surge absorption component, be sure to connect a surge absorption component when using the SSR to control an inductive load.



For additional details on solid-state relays, see the Solid-State Relay Application Guide, publication [700-AT001](#).

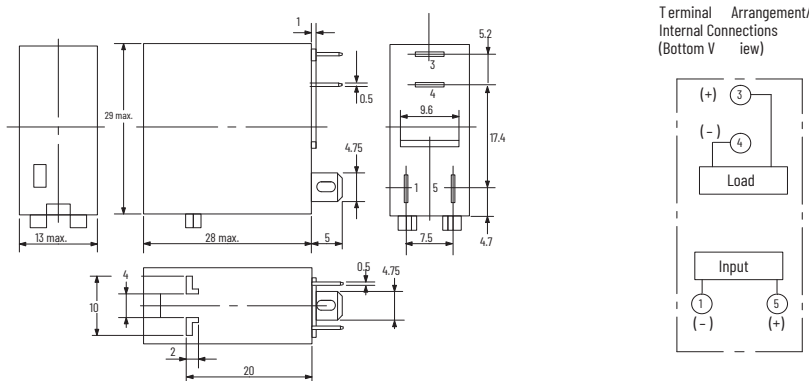
Approximate Dimensions

All units are in millimeters unless otherwise indicated. To convert to inches multiply by 0.0394. Dimensions are not to be used for manufacturing purposes.



The input module (700-SKI) and output module (700-SKO) are compatible with the Cat. No. 700-HN121 socket.

Figure 194 - Cat. No. 700-SK Relay and Terminal Arrangement



Additional Resources

These documents contain additional information concerning related products from Rockwell Automation. You can view or download publications at rok.auto/literature.

Resource	Description
General Purpose, Interposing, Solid-State and Specialty Relays Brochure publication 700-BR018	Provides product overview and applications for Bul 700 relay line.
Solid-state Relay Application Guide, publication 700-AT001	Provides methods for applying and troubleshooting Solid-state relays.
UL Standards Listing for Industrial Control Products, publication CMPNTS-SR002	Assists original equipment manufacturers (OEMs) with construction of panels, to help ensure that they conform to the requirements of Underwriters Laboratories.
American Standards, Configurations, and Ratings: Introduction to Motor Circuit Design, publication IC-AT001	Provides an overview of American motor circuit design based on methods that are outlined in the NEC.
Industrial Components Preventive Maintenance, Enclosures, and Contact Ratings Specifications, publication IC-TD002	Provides a quick reference tool for Allen-Bradley industrial automation controls and assemblies.
Safety Guidelines for the Application, Installation, and Maintenance of Solid-state Control, publication SGI-1.1	Designed to harmonize with NEMA Standards Publication No. ICS 1.1-1987 and provides general guidelines for the application, installation, and maintenance of solid-state control in the form of individual devices or packaged assemblies incorporating solid-state components.
Industrial Automation Wiring and Grounding Guidelines, publication 1770-4.1	Provides general guidelines for installing a Rockwell Automation industrial system.
ProposalWorks™ configuration software, rok.auto/systemtools	Helps configure complete, valid catalog numbers and build complete quotes based on detailed product information.
Rockwell Automation Global SCCR tool, rok.auto/sccr	Provides coordinated high-fault branch circuit solutions for motor starters, soft starters, and component drives.
Product Certifications website, rok.auto/certifications	Provides declarations of conformity, certificates, and other certification details.

Rockwell Automation Support

Use these resources to access support information.

Technical Support Center	Find help with how-to videos, FAQs, chat, user forums, Knowledgebase, and product notification updates.	rok.auto/support
Local Technical Support Phone Numbers	Locate the telephone number for your country.	rok.auto/phonesupport
Technical Documentation Center	Quickly access and download technical specifications, installation instructions, and user manuals.	rok.auto/techdocs
Literature Library	Find installation instructions, manuals, brochures, and technical data publications.	rok.auto/literature
Product Compatibility and Download Center (PCDC)	Download firmware, associated files (such as AOP, EDS, and DTM), and access product release notes.	rok.auto/pcdc

Documentation Feedback

Your comments help us serve your documentation needs better. If you have any suggestions on how to improve our content, complete the form at rok.auto/docfeedback.

Allen-Bradley, expanding human possibility, and Rockwell Automation are trademarks of Rockwell Automation, Inc.

EtherNet/IP is a trademark of ODVA, Inc.

Trademarks not belonging to Rockwell Automation are property of their respective companies.

Rockwell Automation maintains current product environmental compliance information on its website at rok.auto/pec.

Rockwell Otomasyon Ticaret A.Ş. Kar Plaza İş Merkezi E Blok Kat:6 34752, İçerenköy, İstanbul, Tel: +90 (216) 5698400 EEE Yönetmeliğine Uygundur

Connect with us.    

rockwellautomation.com ————— expanding **human possibility**[®]

AMERICAS: Rockwell Automation, 1201 South Second Street, Milwaukee, WI 53204-2496 USA, Tel: (1) 414.382.2000, Fax: (1) 414.382.4444

EUROPE/MIDDLE EAST/AFRICA: Rockwell Automation NV, Pegasus Park, De Kleetlaan 12a, 1831 Diegem, Belgium, Tel: (32) 2663 0600, Fax: (32) 2 663 0640

ASIA PACIFIC: Rockwell Automation SEA Pte Ltd, 2 Corporation Road, #04-05, Main Lobby, Corporation Place, Singapore 618494, Tel: (65) 6510 6608, FAX: (65) 6510 6699

UNITED KINGDOM: Rockwell Automation Ltd., Pitfield, Kiln Farm, Milton Keynes, MK11 3DR, United Kingdom, Tel: (44)(1908) 838-800, Fax: (44)(1908) 261-917

Publication 700-TD552I-EN-P - July 2023

Supersedes Publication 700-TD552H-EN-P - March 2022

Copyright © 2023 Rockwell Automation, Inc. All rights reserved. Printed in the U.S.A.